

PALLADIUM BOOKS® PRESENTS

THE ROBOTECH® RPG BOOK FOUR

SOUTHERN CROSS

BY KEVIN SIEMBIEDA



LONG '87

About this book

Originally published in 1987

This book was first printed in the mid-1980s. Before the Internet as we know it, and even before the term “anime” came to be known in the United States.

Accurate information about the original anime was difficult to find, and the people managing the *Robotech*® intellectual property in those days preferred to keep *their Robotech*® at arm’s length from the original three anime series – *Macross*, *Southern Cross* and *Genesis Climber Mospeada* – that inspired the unique and beloved creation that is **Robotech**®.

As a result, the details and stats behind some of the mecha, characters, vehicles, weapons and settings reflect a different era and mindset than the **Robotech**® we know today. The information and stats reflect that time period, the information available, and the wishes of the *Robotech*® series’ creator and the managers of the I.P. at that time. Palladium Books followed their wishes.

Please enjoy these **Robotech**® RPG books for what they are. Enjoy the nostalgia, and use or adapt the rules, stats, maps and data to the modern **Robotech**® books as you deem desirable. Though different, much of the material of these 1980s and 1990s books is easily modified and adapted to current **Robotech**® RPG titles and **Robotech**® RPG Tactics™.

An important note about the new *Robotech*® RPG titles: When we *relaunched* the **Robotech**® RPG series in the new millennium, we approached the games as if they were brand new to us. Stats and information are all updated and brought in line with the modern history, back story, and mecha, as well as featuring new artwork. That means new stats, deeper history, and new information and equipment. Some titles like **Robotech**®: **The Masters Saga**™ **Sourcebook** contain a wealth of new and exciting mecha, power armor, robots and weapons never before seen in the RPG series. Stats and information from the original books were NOT reprinted, and only a small amount of the past artwork has reappeared in the new *Robotech*® titles.

It is our pleasure to make the original *Robotech*® titles available, once more, with the permission of Harmony Gold, USA, Inc. Enjoy.

– Kevin Siembieda, Publisher & Game Designer, 2017

PALLADIUM BOOKS® PRESENTS
THE ROBOTECH® RPG BOOK FOUR

SOUTHERN CROSS

Dedicated to Richard Burke for his help and friendship.

WARNING

This book contains new and original works of art that are **protected by Federal Copyright Law**. NO artwork may be printed or published in any form, for any reason, without *written permission* from the Publisher of Palladium Books®. The use of this artwork, in any product not produced by Palladium Books® is a Federal crime! ***Offenders will be pursued in Federal Court.***

The cover depicts a Veritech Hover Tank duking it out with a Leader Bioroid.

PDF Edition – April 2017

Sixth Printing – August 1995

Copyright © 1983, 1984, 1985, 1986, 1987 Kevin Siembieda.

Characters copyright © 1985 Harmony Gold U.S.A., Inc./Tatsunoko Production Co. Ltd. All rights Reserved.

Copyright © 1987 by Kevin Siembieda. All rights reserved under the Universal Copyright Convention. No part of this book may be reproduced in part or whole, in any form or by any means, without permission from the publisher, except for brief quotes for use in reviews. All incidents, situations, institutions, governments and people are fictional and any similarity, without satiric intent, of characters or persons living or dead is strictly coincidental.

"ROBOTECH" is a trademark owned and licensed by Harmony Gold U.S.A., Inc.

Palladium Books and Megaverse are registered trademarks owned and licensed by Kevin Siembieda.

ROBOTECH RPG Book Four: Southern Cross is published by Palladium Books Inc., 39074 Webb Court, Westland MI 48185. Printed in the United States of America.

PALLADIUM BOOKS® PRESENTS
THE ROBOTECH® RPG BOOK FOUR

SOUTHERN CROSS

Written By: Kevin Siembieda

Editors: Alex Marciniszyn
Florence Siembieda

Technical Consultant: Richard Burke
Japanese Translator: Koichiro Tanaka

Cover Painting: Kevin Long
Interior Art: Peter Simon
Art Direction: Kevin Siembieda

Typography: Maryann Siembieda
Keylining: Matthew Balent

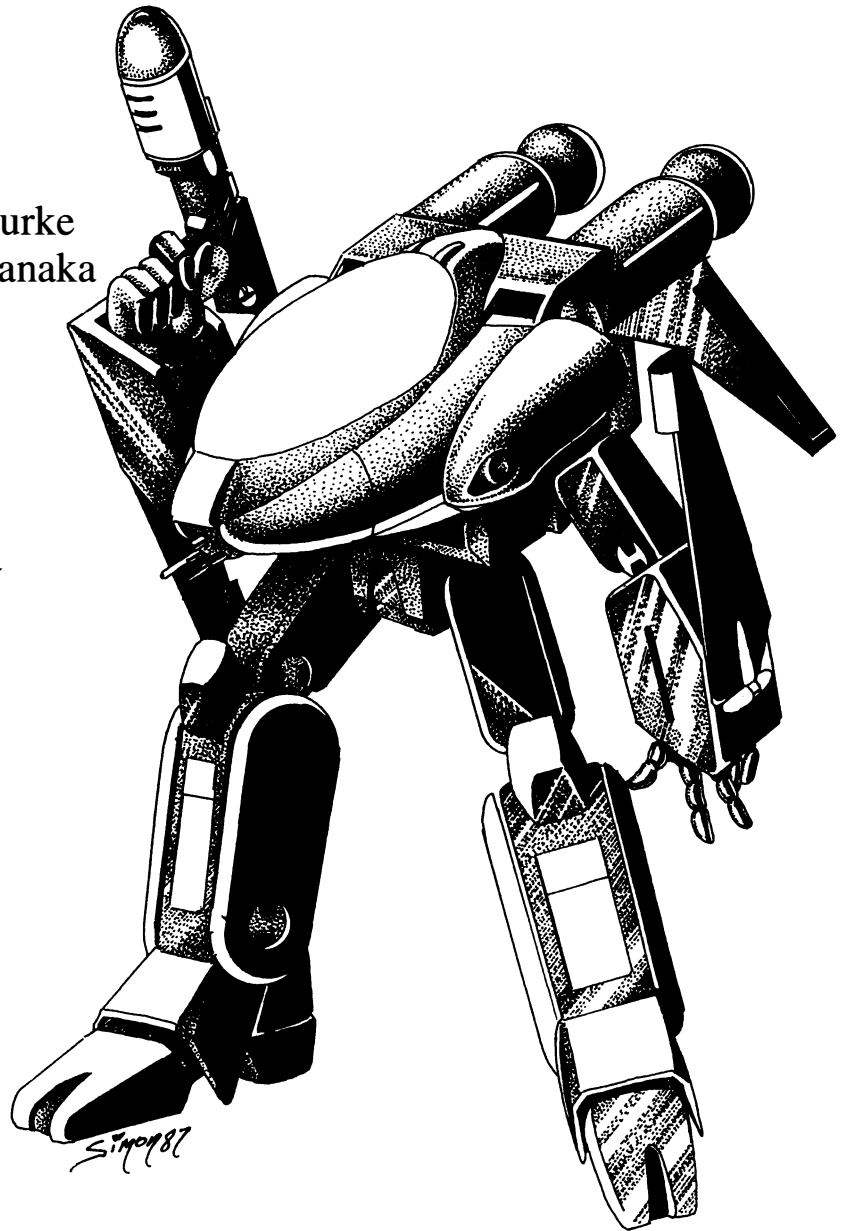

Special thanks to Brenda Brown, Chester Jacques, Richard Burke, Alex, Maryann, Matt and the regular gang of players.

TABLE OF CONTENTS

	Page
Playing Southern Cross	5
Selecting an O.C.C.	5
M.O.S. Skills	6
Education and Skills	6
Skill List	7
Skill Descriptions	8
Mecha Hand to Hand Training	18
Optional Rules	19
The Armies of the Southern Cross	20
Global Military Police	20
Tactical Corp	22
Tactical Air Force	24
Tactical Armored Space Corp	26
Alpha Tactical Armored Corp	28
Recon Escort Patrol	30
Cosmic Unit	31
Civil Defense Unit	33
Civil Defense Flying Corp	34
Cold Weather Offense Squad	36
Humid Climate Offense Squad	37
Mountain Squad	38
Desert Squad	40
Jungle Squad	42
Sea Squad	42
Experience Levels	44
Character Sheets	45
Earth Mecha	56
The Logan	57
The AJACS	59
Veritech Hover Tank	62
Battloids	64
E.B.S.I.S. Battloids	71
G.M.P. Security Robot	76
Ground Vehicles	77
Air Vehicles	80
Weapons & Equipment	85
Body Armor	85
Back Packs	86
Shields	87
Weapons	89
The Robotech Masters	90
Clone Masters	91
Science Masters	92
Bioroid Pilots	93
Bioroids	94
The World of Southern Cross	104

INTRODUCTION

The Southern Cross is a supplement to the original ROBOTECH® RPG: Book One Macross. It is NOT a complete game in itself. Yet, like its predecessor, Southern Cross is directly adapted from the T.V. series and the notes of Carl Macek. Many Robotech fans will notice mecha, vehicles, weapons and equipment they may not remember from the television series. Is this imaginary stuff made up for the RPG? The answer is mostly NO! All the human mecha and other items are based on real material that is *seen* in the series. The running joke at Palladium was that “everything appeared in one episode or another for 10 seconds or less!” So if you blinked or went to the bathroom, you missed it. Seriously, its very true. We see all the Southern Cross battloids described in this book in a 5 second scene in episode 41 or 46. That’s the extent of it. How many of you noticed the green bioroids? They’re actually seen for a minute or two. Dana even captures one.

Only a tiny percentage of material is actually complete extrapolation, like the battloids of the E.B.S.I.S. And even this material is based on model sheets from the original animation. They are just ideas that died on the film editor’s floor (or maybe I blinked at the wrong moment). Data on the Armies, world and Robotech Masters are adapted directly from the notes and ideas of Mr. Macek.

The Southern Cross animated series is unique in that it was an ambitious attempt by a Japanese studio to create a science fiction epic. This was to be the crowning feather in their cap. Unfortunately, in their fervor they introduced too much with too little play time. Consequently, I have tried to spotlight as many of these creations as possible for your gaming pleasure. Within the following pages you will find the world of Southern Cross. The next generation of Earth’s defenders.

PLAYING SOUTHERN CROSS

The same rules for character creation, attributes, hit points, damage, mega-damage, alignments, combat and all the rest are unchanged. *Only the specific Occupational Character Classes (O.C.C.) and the skill selection process are different.* A few new skills have also been added to accommodate some of the new technology.

It is important to stress that players can keep their current characters and easily work them into a Southern Cross adventure. For most players with campaigns set in the post- holocaust world of Macross, the beginning of the Second Robotech War (Southern Cross) is only about ten years in the future. For players recreating the Macross saga the Second War begins approximately 18 years later in the year 2030. I have intentionally designed the game so that no characters from any of the three time-spans become obsolete.

SELECTING THE TIME PERIOD

When selecting an O.C.C. it is important to bear in mind the type of ROBOTECH® scenarios or campaign your game master intends to run. Is it a recreation of the Southern Cross T.V. saga? Earthbound or space adventure? Predominately combat? Pre or post Second Robotech War environment? These are all important questions in order to create a proper character.

The playing environment is presented in such a way that playing time can span a 20 or 30 year period. A strictly *chronological* sequence of play might start around where Macross leaves off, with a post-holocaust world struggling to rebuild itself, circa 2016. You can have members of the fledgling Southern Cross (S.C.) join the combat veterans of the RDF in their efforts to suppress Zentraedi and rebel assaults, hunt down fugitives, combat high-tech bandits, protect the world’s people, and enforce some measure of law and order. From here the

S.C. and R.D.F. could join forces with the E.B.S.I.S.; first in the Africa Sector, then back to South America and North again to the Arkansas Protectorate in the *two years of conflict* which once and for all roots out the evil of the insane, rogue Zentraedi (circa 2019-2020). Both situations offer an excellent and logical opportunity to combine R.D.F. and S.C. characters, O.C.C.s, equipment and mecha. Even after the majority of the Robotech Defense Force leaves Earth, along with Rick, Lisa, Max and the others aboard the SDF-3, there are sufficient number who remain on Earth to continue to combine RDF mecha and characters with the events and characters of the Southern Cross.

Rather than adhere to any chronological pattern, players can just as easily jump 15 years into the *Second Robotech War*. The T.V. series focuses on the major battles in and around Monument City, headquarters of the Armies of the Southern Cross. It also shows us the space battles conducted by the Armies at Monument City. But this is a world war with battles and conflicts across the globe and into the reaches of outer space. Your adventures can take place anywhere! At Monument City, rubbing elbows with Dana Sterling, Bowie Grant, Nova Satori, Zor and the others, or Scandinavia at the United Earth Government headquarters, or anywhere else on the planet. Tired of Earthbound adventures? Then go into space. Space adventures offer the two moon bases: Aluce and Luna, Mars bases, and combat shuttle assaults into the void itself. You can play the untold story. Again, you have the flexibility of combining the characters, weapons, vehicles and mecha from the previous Macross/RDF books.

If none of this suits your fancy, you can develop adventures in the post-holocaust world *after* the Second Robotech War. The Robotech Masters are defeated, but without sufficient protocolure to power their massive vessels, many of their people remain on earth. Like the Zentraedi before them, the surviving forces are confused, hostile and aggressive. Perhaps their presence rallies the few, remaining, rouge Zentraedi into action in more senseless skirmishes, but this time their forces are bolstered with bioroids. Perhaps some of the maniacal Robotech Master clones enslave a town and turn them into a zombie-like force of bioroid pilots. Perhaps they claim their own territory or incite new conflicts between the feudal states of the splintered Earth governments. *The possibilities are yours to explore.*

SELECTING AN O.C.C.

Whew! Once a time period and type of adventure has been determined, it is time to create a playing character. All the O.C.C.s from the ROBOTECH® RPG: Book One are available, and suitable in the world of Southern Cross. The Southern Cross O.C.C.s in this book are compatible, but a little different. **The Southern Cross** is a strictly military force divided into fifteen armies. Each army has a specific orientation, training program and area of expertise. This is reflected in each of the Occupational Character Classes and the way in which skills are determined. The number of O.C.C. skills is greater while remaining skill selection is divided into two categories: *Military Occupational Specialty (MOS)* and “*Other*” Skills.

The O.C.C. skills are automatic and indicative of the focus and orientation of that particular Army. **The Military Occupational Specialty (MOS) skills** relate directly to a specific skill area, such as communications, espionage (intelligence), medical, weapon’s expert, combat/physical training (Green Beret or Special Forces type), pilot, mechanic and so on. The choice of skills selected for a MOS is limited to that one area of expertise. **The “other” skills** enables you to select individual skills from a large variety of skill categories to round out your character.

For example: You have chosen the Alpha Tactical Armored Corp (A.T.A.C.), Veritech Hover Tank pilots, as your O.C.C. **First**, you must meet the *minimum attribute requirement(s)*; in this case an I.Q.

of no less than 7. **Second**, you will see a list of *O.C.C. skills*, with skill bonuses in parenthesis. These skills are automatic for ALL A.T.A.C. characters. It is part of their military training and orientation. The skill bonuses reflect the degree of training and skill proficiency. **Third**, is the selection of MOS skills. *M.O.S. means Military Occupational Specialty*. After your character finishes basic training (O.C.C. skills), he or she selects an area of additional training, in other words, a *military specialty*. This is standard military practice. Players of our Recon game will recall that they too select a M.O.S. which relates directly to their position in the recon team. The RTO is the communications expert, the Medic is the doctor or paramedic, the Pigman is the machine gunner and so on. The idea is to establish an independent group that can pool their resources to create a superior, interactive, fighting force. *The A.T.A.C. character* can select any one of the M.O.S. categories, with the exception of military intelligence. **In this example**, the player selects *communication* as the M.O.S. This provides the skills: read sensory instruments, radio: basic, and a *choice* of FOUR additional communication skills. The M.O.S. skill bonus for these six M.O.S. skills is +20%. Sometimes a skill will be *repeated*. In this case, the read sensory instruments is an O.C.C. skill (with a +15% O.C.C. skill bonus) and a M.O.S. skill (with a +20% M.O.S. skill bonus). Keep the skill do NOT pick another to replace the duplicate. This is simply additional training in the same skill, after all, it is one of your military specialties. As for the two, conflicting *skill bonuses*: apply the highest (+20% M.O.S.) and discard the lower (+15% O.C.C.). **DO NOT add the bonuses together.**

Lastly, the player selects "other" skills as additional skills and knowledge. The other skills are listed by skill category, with indications of which skills are available. This is exactly like the skill selection process in the ROBOTECH® RPG. **Note:** A player can NOT select a skill which is a duplicate of an O.C.C. or M.O.S. although other skills within that same category may be available. **For example:** Our A.T.A.C. player selects Radio: Scrambler, Radio: Satellite, Surveillance and T.V./Video and has his/her four M.O.S. communication skills (plus radio: basic and read sensory instruments, which are automatic for that M.O.S.). That leaves cryptography, laser and optic systems in the communications skill category. Communications is also a skill category available under Other skills. This means the player can select one or all three of the remaining communication skills, if desired. Remember, the M.O.S. bonus does not apply to "other" skills.

GAME MASTER'S NOTE

Let the players select their O.C.C. whenever possible. Characters with different skills, armor, and mecha from the various Armies, can be combined into a special team of operatives. If the players all want to play Veritech Hover Tank pilots (A.T.A.C.) or AJACS Attack 'Copter pilots (T.A.S.C.), or whatever, that's okay too.

Veritech Hover Tank pilots/ A.T.A.C. soldiers will always be assigned a VHT and a hover cycle. They can not pilot the AJACS, Logan, VF-series Veritech Fighter or Destroids. Additional training in piloting non-transformable battloids (pilot battloid and battloid combat) can be selected.

The Tactical Armored Space Corp (T.A.S.C.) is the only O.C.C. trained to pilot the AJACS and Logan. They can not operate a Veritech Hover Tank, VF-series Veritech Fighter (although they could learn quickly) or Destroids. Non-transformable battloid piloting is not a part of T.A.S.C. training, but can be selected if desired.

The other Armies of the Southern Cross can not be trained to pilot the VHT, AJACS, Logan, Veritech Fighter or Destroids. However, several utilize non-transformable battloids, and all O.C.C.s can select the battloid pilot and combat skills if desired.

About the hand to hand combat skills. In many instances the player can upgrade the character's hand to hand at the cost of one of the "other" skills. This means sacrificing one of the, so-called, "other" skills to get a better hand to hand skill. This is an option left solely up to the player, but you should remind mecha pilots that the better the

hand to hand, the better their mecha combat abilities.

EDUCATION and SKILLS

MILITARY OCCUPATIONAL SPECIALTY (M.O.S.)

M.O.S. skills are divided by skill categories. Exactly which M.O.S. categories are available will be listed under each O.C.C. Types of M.O.S. and skill limitations by category are as follows:

COMMUNICATIONS M.O.S.

Read Sensory Instruments, Radio: Basic and a choice of 4 skills from the Communications category. Skill Bonus: +20% on all M.O.S. skills.

ELECTRICAL ENGINEER M.O.S.

All Electrical skills, Basic and Advanced Math and a choice of 2 skills from the Technical category. Skill Bonus: +15% on all M.O.S. skills.

MILITARY INTELLIGENCE M.O.S. (Espionage)

Select 6 from Espionage category. Skill Bonus: +15% on all M.O.S. skills.

MECHANICAL ENGINEER M.O.S.

Basic and Advanced Math and a choice of 3 skills from the Mechanical category. Skill Bonus: +15% on all M.O.S. skills.

MEDICAL M.O.S.

Basic Math, a choice of 2 skills from Science (excluding astrophysics) and a choice of 2 skills from the Medical category. Skill Bonus: +10% on all M.O.S. skills.

COMBAT M.O.S.

Select 4 from the Physical category and 3 additional Weapon Proficiencies. Skill Bonus: (when applicable) +10%.

WEAPONS M.O.S.

Sniper and Weapon Systems, plus a choice of any 6 Weapon Proficiencies. Skill Bonus: (when applicable) +10%; +1 to strike with all weapons he/she is skilled in.

PILOT M.O.S.

Navigation and a choice of any 8 vehicle types, including Battloid Mecha Combat and Pilot Battloid (*but excluding* the AJACS, Logan, Hover Tank, and old Destroids and VF series Veritech). Skill Bonus: +15%.

SCIENCE M.O.S.

Computer Operation, Basic and Advanced Math, and a choice of any 3 additional Science skills. Skill Bonus: +15%.

The characters in this game are all highly educated or specially trained. Each Occupational Character Class (O.C.C.) will indicate how many total skills can be selected and if any restrictions apply to skill categories.

Several new skills are added to those available in the ROBOTECH® RPG: Book One. These *new skills* are indicative of technological advancement and new mecha. All of the new skills can be learned by any of the original (R.D.F.) O.C.C.s, except as follows: Pilot Logan and Pilot AJACS is automatic for the Veritech Pilot O.C.C., while Pilot Battloid is *automatic* for the Destroid Pilot. Pilot Veritech Hover Tank is a new skill available to both the Veritech and Destroid Pilot O.C.C. ONLY. These specific, mecha related skills are reserved exclusively to the Veritech and Destroid Pilot O.C.C.s. All other skills, including Pilot Battloid, are available to all O.C.C.s.

SKILLS LISTED BY CATEGORY

COMMUNICATIONS

Cryptography
Laser
Optic Systems
Radio: Basic
Radio: Scrambler
Radio: Satellite
Surveillance
T.V./Video

Note: Read Sensory Instruments is found under Pilot related skills.

DOMESTIC

Cook
Dance
Fish
Sew
Sing

ELECTRICAL

Basic Electronics
Electrical Engineer
Mecha Electronics: The same skill, but includes the new mecha.

ESPIONAGE/MILITARY

Detect Ambush
Detect Concealment
Disguise
Escape Artist
Forgery
Intelligence
Impersonation
Interrogation
Land Navigation
Pick Locks
Pick Pockets
Sniper
Tracking
Wilderness Survival

MECHANICAL

Automotive Mechanics
Aircraft Mechanics
Computer Repair
Locksmith
Mecha Mechanics
Mechanical Engineering
Veritech Mechanics: The same skill, but includes the Logan, AJACS and Hover Tank.

MEDICAL

Criminal Science/Forensics
First Aid
Medical Doctor
Paramedic
Pathology

PHYSICAL

Hand to Hand Basic
Hand to Hand Expert
Hand to Hand Martial Arts
Body Building
Boxing
Climbing
Fencing
Gymnastics

Prowl
Swimming
Swimming S.C.U.B.A.
Wrestling

Note: Mecha combat is found under Pilot Skills.

PILOT (Ground, Air and Water)

Automobile
Mecha (Destroid only)
Mecha: Battloid Only
Mecha: E.B.S.I.S. Battloids Only.
Mecha Combat: Includes new mecha.
Motorcycle
Truck
Tank
Hovercycle
Hover Vehicles
Airplane; old style, single or twin engine.
Helicopter
Jet Pack
Jet
Lancer Space Fighter
Space Shuttle
Boats: Sail
Boats: Motor

PILOT RELATED SKILLS

Navigation (Air, Land, Water)
Navigation: Space
Read Sensory Instruments
Weapon Systems (missiles, lasers, etc.)

SCIENCE

Astrophysics
Biology
Botany
Chemistry
Chemistry: Analytical
Mathematics: Basic
Mathematics: Advanced

Note: Computer is found under Technical.

TECHNICAL

Computer Operation
Computer Programming
Demolitions
Demolitions: Disposal
Photography

Note: Instrument Reading; see Pilot Related Skills.

WEAPON PROFICIENCIES (W.P.)

Ancient Weapons
W.P. Blunt
W.P. Chain
W.P. Knife
W.P. Sword
W.P. Staff
Also see Fencing under Physical Skills.
Modern Weapons
W.P. Revolver
W.P. Automatic Pistol
W.P. Semi & Fully Automatic Rifle
W.P. Rifle
W.P. Sub-Machinegun
W.P. Heavy
W.P. Energy Pistol
W.P. Energy Rifle

Note: Weapon Systems; see Pilot Related Skills.

SKILL DESCRIPTIONS

NOTE: For your convenience, we have reprinted the old skill descriptions with the new. This way you don't have to continually flip through TWO different books.

COMMUNICATIONS

Cryptography: Skill in recognizing, designing, and cracking secret codes and messages. After ten minutes of studying a code the character can attempt to decipher it, but at a -10% chance. Otherwise, the character must study for two hours before every additional roll. **Base Skill:** 30% + 5% per level of experience.

Laser: This skill provides the character with an in depth knowledge of laser communication systems. **Base Skill** is 40% + 5% per level of experience.

Optic Systems: Training covers a wide variety of optic systems, from video to optical enhancements devices, to Laser Optics. The character will understand the operation of optical readings, recording, transmission, and use of special equipment like thermo-imagers, passive light intensifiers, infrared, ultraviolet, etc. **Base Skill:** 50% + 5% per level of experience.

Radio Communications: All these skills enable the character to effectively use various communications equipment and techniques.

Radio: Basic Communications: This is the knowledge of the operation and maintenance of field radios and walkie-talkies, wire laying, installation, radio procedure, communication security and visual signs/communications, as well as knowing Morse Code. **Base Skill:** 50% + 5% per level of experience.

Radio: Scramblers: This is training in the use of electronic masking and scrambling (unscrambling) equipment, and codes, for increased security. **Base Skill:** 40% + 5% per level of experience.

Radio: Satellite Relay: This is an understanding in the methods and operations of satellite transmissions. **Base Skill:** 25% + 5% per level.

Surveillance Systems: This is the study and understanding of the operation, methods, and techniques in the use of surveillance systems. Includes motion detectors, simple alarm systems, complex alarm systems, video and camera equipment, amplified sound systems, miniature listening devices (bugs, telephone tapping), recording methods, and some optical enhancement systems (specifically as they relate to camera lenses). **Requires:** Electronics (basic) or electrical engineering. Photography skills, prowl, and investigative skills may also be useful, but not required. **Base Skill:** 40% + 5% per level of experience.

Tailing, or following someone without their knowledge, is another form of surveillance. This also includes stake-out procedures. A failed surveillance roll indicates that the tail was spotted and the subject is aware of being observed/followed. A failed roll in the use of equipment indicates ruined or garbled recording/film (not usable) or malfunction. Bugging equipment can be easily located or noticed through the course of casual activity if a character fails his surveillance roll while planting it.

T.V./Video: Techniques and understanding of video and audio, filming, editing, special effects, transmissions and equipment. **Base Skill:** 40% + 5% per level of experience. Spending two skills on this one skill area makes the character of professional film quality/abilities. A one time bonus of 10% applies in this case.

DOMESTIC

Cook: Skill in selecting, planning and preparing meals. A cooking roll failure means that the cooked food is either inedible (burnt!) or distasteful. **Base Skill:** 50% + 8% per level of experience. Spending two skill selections on this one skill area makes the character of professional quality. One time bonus of 10% applies in this case only.

Dance: A practiced skill in the art of dancing. **Base Skill:** 40% + 6% per level of experience. Spending two skills will produce professional quality dancing skill. One time bonus of 15% if this is the case.

Fishing: These is the fundamental methods and enjoyment of the relaxing sport of fishing. Areas of knowledge include the use of lures, baits, poles, line, and the cleaning and preparation of fish for eating. **Base Skill:** 60% + 5% per level of experience.

Sewing: The practiced skill with the needle and thread, to mend, layout, cut and sew simple patterns, and do minor alterations. This is not a tailoring ability, unless the player spends two skills. **Base Skill:** 40% + 5% per level of experience.

Sing: The simple ability to read music and carry a pleasant tune. **Base Skill:** 40% + 5% per level of experience. The character's singing ability is nice, but not of professional quality, unless two skills are spent. Add 20% bonus if this is done. Minmei watch out!

ELECTRICAL

Basic Electronics: This is a rudimentary understanding of the principles of electricity, simple circuits, wiring, and so on. This person can do basic wiring, repair appliances and read schematics. **Base Skill:** 40% + 5% per level of experience.

Electrical Engineer: Knowledge of electricity. Characters can diagnose and locate electrical problems. It is also possible to put together electrical equipment. The character can attempt to bypass security systems and burglar alarms at a -25%; if Surveillance Systems is also taken, then there is a +10% bonus instead. **Base Skill:** 45% + 5% per level of experience. **Note:** Characters who are not electrical engineers must have Basic and Advanced Mathematics to select this skill.

Mecha Electronics: Firsthand knowledge of the electrical systems built into the *Logan*, *AJACS*, *Battloids* and the old *Destroids* and *VF series Veritech Fighters*. You know how they interact with pro-culture and the fundamentals of Robotechnology. Other areas of electrical expertise do not apply to Mecha, making this an invaluable skill in repairing the famous war machines. **Base Skill:** 35% + 5% per level of experience.

ESPIONAGE/MILITARY

Detect Ambushes: Training which develops an eye for spotting locations and terrain suitable for ambushes and being ambushed. It also provides a rudimentary knowledge of guerrilla tactics used by the enemy. **Base Skill:** 50% + 5% per level of experience.

Detect Concealment: This is a skill which enables the individual to spot and recognize camouflage, tricks, concealed huts, buildings and vehicles, as well as the ability to construct unobtrusive shelters that blend into the environment. **Base Skill:** 40% + 5% per level of experience.

Disguise: The character knows how to apply make-up, wigs, skin putty, and other special effects, in order to alter his own appearance or those of somebody else. **Base Skill:** 40% + 3% per level of experience.

Escape Artist: The character will know the methods, principles, and tricks of escape artists. By tensing and relaxing muscles, flexing and popping joints; the character can try slipping out of handcuffs, straightjackets, etc. Also includes a knowledge of knots and the ability to conceal small objects on the person. Picking Locks is a separate skill. **Base Skill:** 30% + 5% per level of experience.

Forgery: The techniques of making false copies of official documents, signatures, passports, I.D., and other printed material. The character must have an original or photocopy to work from, in order to make an accurate copy. Skilled forgers can recognize other counterfeits at -6%. **Base Skill:** 30% + 5% per level of experience.

Intelligence: This is the specific training in the practices and principles of recognizing and analyzing sources of information about the

enemy, observation techniques, counterintelligence measures and proper procedure. This includes the practical assessment of sights, and sounds; estimation of ranges, what to report, handling prisoners of war, and handling captured documents and equipment (tagging, and reporting to group leader or proper authority).

This means the character will be able to accurately estimate ranges; the number of enemies/troops, direction, purpose; and assess the importance of specific information, documents and prisoners.

Further intelligence training includes a working knowledge of indigenous guerrilla warfare, practices, concealment techniques, appearance, and current activities. This will enable the intelligence officer to recognize suspicious activity as guerrilla actions and identify guerrilla operatives. **For Example:** A particular booby trap, or weapon, or mode of operation, may be indicative of guerrilla activity in that area. It may be up to the character to confirm the existence of guerrillas, and their strengths and numbers in a particular area.

Another area of training, made available to intelligence, is the identification of enemy troops, officers and foreign advisors. This means the person learns the many distinguishing ranks and marks that identify specific military units, special forces, and officers of the enemy. Such identification can pinpoint and confirm enemy operations, goals and movement, as well as confirm outside intervention/aid. **Note:** A failed roll in any of the intelligence skills means that evidence is inconclusive, or the character has incorrectly assessed the information/situation and is uncertain. A failed roll involving individual clues may mean the intelligence officer has dismissed it entirely as being meaningless. (GM's, use your discretion). **Base Skill:** 45% + 5% per level of experience.

Impersonation: This skill enables a person to impersonate another person or type of soldier (in general). This means the person must have a rudimentary (if not comprehensive) knowledge of the person or general type of personnel that he is impersonating. This is likely to include a knowledge of enemy/subject of impersonation military procedure, dress, command, rank, and will usually require speaking the language fluently. This means the character can convincingly impersonate a general type of person/soldier/advisor by accurate disguise, proper action, and language.

The **Base Skill** is 40% to impersonate general personnel and 20% to impersonate a specific individual (which may require weeks of study and special disguise), +4% per level of experience.

The success of one's impersonation/disguise can only be determined after exposing oneself to those whom you wish to trick. A successful impersonation requires the player to roll under his skill for each of his first, THREE encounters. Afterward, the character must roll under his skill for *each* encounter with an officer. If interrogated/questioned, he must successfully roll for every other question or be revealed as an imposter. A **failed roll** means his impersonation has failed and is recognized as an imposter and is in immediate danger.

Interrogation: This skill includes training in the questioning of prisoners, captives and informers, and the assessment of that information. **Base Skill:** 40% + 5% per level of experience.

Land Navigation: This skill allows the person to stay on course, while traveling over land, by means of observation. This includes mentally marking/recognizing geographic landmarks, estimating distance and movement, recognizing sounds and other navigation tricks. Techniques include night travel. The player should roll once for approximately every three miles traveled. A failed roll means the group is drifting off course by 200-2000 yards (roll 2D10 × 100 yards). Do not roll again until the next three miles. A successful roll at that time will allow the character to recognize his error and correct it. Of course, errors mean lost time and traveling through unknown or potentially dangerous areas. A second (and third), failed roll means the team continues to travel 2D10 × 100 yards further off course. All failed rolls are cumulative unless corrected.

Note: A group of average men can cover approximately 5 miles an hour at a brisk, but relaxed pace, through grassland, along dirt roads or paved streets. Travel through dense forest or jungle at a cautious pace, with eyes open for danger, is about one mile per hour. At this pace, one can easily watch for booby traps, snipers, ambushes, wild animals, tracks, clues and other observations, without fear of traveling too fast (and missing them). Only at a faster pace will one begin to miss details and court death. **Base Skill:** 45% + 5% per level of experience.

Picking Locks: The character knows the methods, techniques and tools for picking/opening, key, and basic, tumbler type locks.

It takes 1D6 melee rounds for each attempt to pick a lock. A failed roll means the lock holds; try again. **Base Skill:** 35% + 5% per level of experience.

Pick Pockets: An ability to remove items from a person without their being aware of it. If a pick pocket attempt fails, the item has NOT been removed and there is a 67% likelihood of the intended victim recognizing the intent of the action. **Base Skill:** 30% + 5% per level of experience.

Sniper: This skill represents special training in long-range rifle firing, and marksmanship. The character must first have a semi-automatic rifle or bolt-action rifle skill, to which the sniper skill bonus of +2 to strike can be applied.

Tracking: Visual tracking is the identification of tracks, and following the path of men or animals by the signs they leave on the ground and vegetation. Tracking is a precise art, requiring much practice. The skill includes the evaluation of tracks, indicating whether the person being tracked is loaded down with equipment, running, moving slowly (by measuring the space between steps), male, female, walking backwards, injured (staggered footprints), and so on. By this means, the tracker can estimate the person's rate of movement, apparent direction, the number of persons in the party, and whether the person knows he's being followed. Other methods of tracking require recognizing other, telltale signs, such as blood and other stains, broken and displaced vegetation, overturned rocks; litter, such as cigarette butts, ration cans, candy wrappers, soiled bandages and remains of camp fires, and even odors carried by the wind.

Tracking also includes the recognizing of dangerous animals by their tracks, habits and feces. Likewise, tire tracks of vehicles can reveal much, such as size and type of vehicle, weight of load, etc.

Counter-Tracking techniques are also known, such as covering one's trail; avoiding obvious pitfalls, such as littering, misdirection, parallel trails, and others.

A **failed roll** means that the signs are inconclusive, vague or misleading. Additional signs must be found to verify or clarify (roll again). Three, consecutive, failed rolls means the tracker has completely lost the trail. Roll once every 40 yards when FOLLOWING a trail. Persons attempting to follow a skilled tracker are -20% in following his trail, if he is deliberately trying to conceal that trail (however, his rate of travel is reduced by half). **Base Skill:** 35% + 5% per level of experience.

Wilderness Survival: Techniques for getting water, food, shelter, and help, when stranded in wild forests, deserts or mountains. Characters without this skill will not be able to stay healthy for more than a day out in the wilderness area. **Base Skill:** 40% + 5% per level of experience.

MECHANICAL

Automotive Mechanics: Ability to repair, rebuild, modify, and redesign conventional vehicles with internal combustion (gas) engines. Body work, turbine engines, and diesel truck engines, each require separate skills. **Base Skill:** 50% + 5% per level of experience.

Aircraft Mechanics: The understanding, ability to repair, rebuild, modify and redesign conventional aircraft; including single and twin

engine airplanes, fan jets, jets, fighter jets, helicopters and shuttle craft. The Veritech Fighter is not a conventional aircraft and does not apply. **Base Skill:** 45% + 5% per level of experience.

Computer Repair: Knowledge of the internal electronics of computers and related devices (terminals, printers, etc. . . .). The character can attempt to repair, sabotage, or fix computers. Note that figuring out a repair problem requires one roll: the character must roll again before actually fixing it. No computer operation or programming skills are included; many computer repair personnel don't even know how to turn the machines on! **Base Skill:** 40% + 5% per level of experience.

Locksmith: The practiced study of lock designs, and ability to repair, build, modify and "open" locks. The methods, techniques, and tools of lock picking include the old-style key and tumbler, combination, and modern electronic locking systems. **Time Requirements:** 1-4 meelees to open an antiquated, key type lock; 1-6 minutes to open an elaborate tumbler type; 2-16 minutes to open a simple electronic lock (usually by patching in a bypass system); and 1-6 hours to break a complex, state-of-the-art electronic lock system, such as those used in high security and restricted areas.

If an unsuccessful skill roll is made, the lock is *not opened and the process must be repeated. If an attempt to open an electronic lock fails, roll to see if the lock has been irreparably damaged; 32% chance. If damaged, the lock CANNOT be opened.* **Base Skill:** 25% + 5% per level of experience. **Special Bonus:** Add a one time bonus of 5% if the Electronics Skill is also taken.

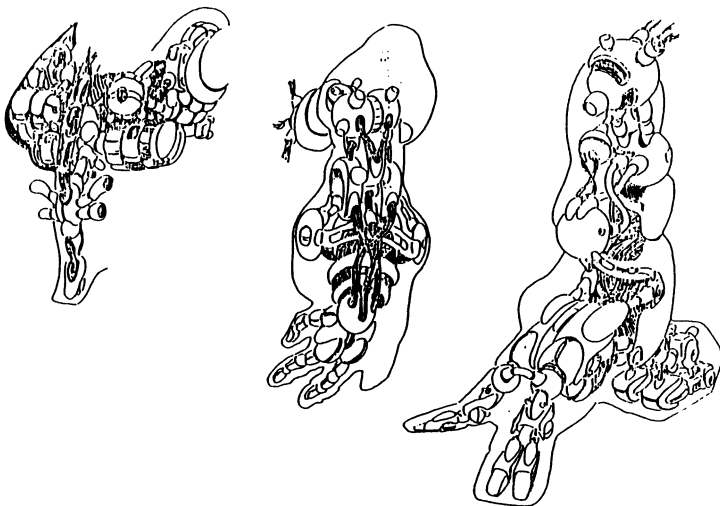

Mecha Mechanics: A comprehensive knowledge and ability to repair, build, and modify Mecha, including the *Logan, AJACS, Battloids* and the old *Destroids*. Veritech Fighters are *not* included; their transformable nature calls for additional training (see Veritech Mechanics). **Base Skill:** 40% + 5% per level of experience.

Mechanical Engineer: A training, understanding and knowledge of how machinery is designed, operated, built, and maintained. Characters can attempt to redesign, modify, sabotage, repair, or construct mechanical devices. The first percentage is how to operate/analyze/design machinery; the second is how to repair, construct or sabotage. **Base Skill:** 45% + 5% per level of experience. **Special Bonus:** + 5% to Locksmith skill and 5% to Surveillance Systems skill.

Veritech Mechanics: A very specialized skill, dealing with the repair, building and modification of the unique, *transformable* Mecha. This includes the old VF series. Veritech Fighter, *Logan, AJACS, Veritech Hover Tank* and all other transforming mecha. The battloids are a piece of cake to repair if you have this skill. (+ 10%). **Base Skill:** 30% + 5% per level of experience.

MEDICAL

Criminal Sciences & Forensics: Basic knowledge of police skills.

Includes simple criminal law, fingerprinting, ballistics (matching bullets to weapons and angles of impact), and general investigative techniques. Forensic medicine is also included, allowing the character to find evidence of time of death, cause of death, and other details when examining a corpse. **Note:** Biology, Chemistry, Chemistry-Analytical and some Mathematics, are all required before taking Criminal Sciences & Forensics. **Base Skill:** 35% + 5% per level of experience.

First Aid: Rudimentary medical treatment which includes how to bandage wounds, stop bleeding, administer CPR/artificial respiration, and use antiseptics, and common anti-inflammatory drugs and pain killers. **Base Skill:** 50% + 6% per level of experience. A failed roll means the patient has not responded to treatment or that treatment was improperly applied.

Paramedic: An advanced form of medical emergency treatment which includes *all* first aid techniques, the setting of broken bones, suturing of wounds, use of oxygen and emergency equipment, use of drugs, knowledge of how to move a critically injured, person and other lifesaving techniques. A **failed roll** means the patient has not responded to treatment or that the treatment has been improperly administered. **Note:** For serious injury or coma, roll three times, consecutively, on percentile dice. A roll of two successful out of three, means the wound has been properly treated or the patient's condition is stabilized. Failure means the patient's condition is unchanged. Another character can immediately attempt to apply medical aid or the same player can try again, but only after he or she has spent six minutes of examination and/or concentration. **Base Skill:** 50% + 5% per level of experience.

Medical Doctor: The character has a Ph D (doctorate degree), with Master's of Science, to be a practicing doctor.

Areas of training/study include: clinical skills, medical discipline, code of ethics, laboratory skills, techniques, methods of data collection, physiology (muscles, respiratory, blood, body fluids); fundamentals, principles and procedures of pathology (diseases, their structure and function), rudimentary pharmacology (use, reaction, and interaction of drugs). The medical doctor (M.D.) is also trained in surgical procedures (he is a surgeon). **Note:** the first percentile number indicates the ability to diagnose a problem and the second is the ability to successfully treat it. **Base Skill:** 70/60% + 5% per level of experience.

Pathology: This is that branch of medicine that deals with the nature of diseases, their causes and symptoms, and the functional and structural changes caused by disease. Training includes anatomy, physiology, cell biology, manifestation of disease, tissue injury and repair, abnormal cell structure, metabolism, diagnosis of human disease, tissue culture methods and applications, analysis of drugs in biological samples and laboratory research, investigative methods, and use of instruments tools and equipment. **Requirements:** Chemistry. **Base Skill:** 45% + 5% per level of experience.

PHYSICAL

Hand to Hand Combat: There are three major kinds of fighting techniques available to all characters:

Hand to Hand Basic: This provides the fighting techniques taught in military basic training or in self-defense classes. Students learn elementary methods of attack and self-defense. Counts as one skill. *See the combat section for listing of specific abilities.*

Hand to Hand Expert: An advanced form of self-defense and unarmed combat usually taught to commandos. Counts as two skills. *See the combat section for listing of specific abilities.*

Hand to Hand Martial Arts: This is some form of oriental fighting skill (karate, kung-fu, etc.) that teaches advanced hand to hand combat. Counts as three skills (except for the Military Specialist and special conditions for upgrading Hand to Hand Combat). *See*

the combat section for listing of specific abilities.

Body Building & Weight Lifting: By working out with weights and body building machines the character increases body strength and muscle.

+ 2 to P.S.
+ 10 on S.D.C.

Boxing: Classic art of fighting with fists. Training helps build the body and reflexes. Skilled boxers will *Automatically* Knockout opponents on a natural twenty, for 1D6 melees rounds. Unlike normal Knockout/Stun, this does NOT have to be declared before the strike roll.

One additional attack per melee.
+ 1 to Parry/Dodge
+ 1 to Roll with Punch/Fall
+ 2 to P.S.
+ 3D6 on S.D.C.

Climbing: Knowledge of the tools and techniques for climbing up sheer surfaces. Players should roll once for every 20ft (6m) of a vertical climb. Every "skilled" climber gets a second roll to recover his/her hold. **Base Skill:** 50% + 5% per level of experience.

Rappelling is a specialized, rope climbing skill used in descending from helicopters, scaling walls and cliff facings. For game purposes, rappelling will include ascending and descending climbs. Minimum base effectiveness is 30% + 5% per level of experience. A failed roll means a slip or fumble; roll again to regain hold or fall.

Fencing: The ancient arts of Hand to Hand Weapons are learned from fencing teachers. This includes not only olympic-style fencing with foil, epee or saber, but also Kendo (use of the Samurai sword) and other weapons. Adds a bonus of +1 to strike and parry when combined with W.P. Sword. **Note:** Paired Weapons is a separate skill. See the W.P. Tables in the Combat Section for details.

Gymnastics: Learning to do falls, rolls, tumbles, cartwheels, and to work on rings and parallel bars. Characters with Gymnastics can leap 4ft up or 4ft across, with an additional, 2ft per level. **Note:** Characters with Leap Attack can use these distances in a strike. Provides the following abilities:

60% + 5% per level Sense of Balance.
70% + 4% per level Climb Rope.
20% + 6% per level Climbing (or adds a bonus of + 10% to a climb skill).
70% + 8% per level Back Flip.
30% + 5% per level Prowl.
+ 1 to Roll with Punch/Fall.
+ 1 to P.S.
+ 1 to P.P. + 3D6 on S.D.C.

Prowl: This skill helps the character to move with stealth; quietly, slowly and carefully. Techniques include balance and footing, short steps and pacing, rifle positioning, prone positions for low visibility, and crawling. A failed Prowl roll means that the character has been seen or heard. If the Prowl is successful, then the character is not seen and may make a Sneak Attack. **Base Skill:** 40% + 5% per level of experience.

Swimming: The rudimentary skill of keeping afloat, dives, lifesaving, and swimming techniques. **Base Skill:** 50% + 5% per level of experience. The percentile number indicates the overall quality of form as skill of execution. A special bonus of +1 to parry and dodge while in water applies. **Note:** A character can swim a distance equal to 3 × his P.S./Strength in yards/meters per melee. This pace can be maintained for a total of melees equal to his P.E./Endurance.

S.C.U.B.A.: The letters S.C.U.B.A. stand for Self-Contained Underwater Breathing Apparatus. Characters learn the methods of skin diving, and underwater swimming; and use of oxygen tanks/apparatus, mask and flippers. **Base Skill:** 50% + 5% per level of experience and reflects the degree of skill and expertise at S.C.U.B.A.

Note: A character can swim a distance equal to 2 × his P.S./Strength in yards/meters per melee. This pace can be maintained for a length of time equal to the character's P.E./Physical Endurance in melees.

Wrestling: As taught in High Schools and Colleges, wrestling is more of a sport than a combat skill, but it does provide useful combat training.

Pin/Incapacitate on a roll of 18, 19 or 20.

Crush/Squeeze does 1D4 damage.

Body Block/Tackle does 1D4 damage and opponent must Dodge or Parry to avoid being knocked down.

+ 1 to Roll with Punch/Fall.
+ 1 to P.S.
+ 1 to P.E.
+ 4-24 on S.D.C. (roll 4D6).

PILOT SKILLS (Ground, Air, Water)

Automobile: Manual & Automatic transmission includes dune buggies and jeeps. **Base Skill:** 80% + 4% per level of experience.

Mecha (Battloid only): (NEW): Characters with this skill are taught the fundamentals of maneuvering giant Battloids. All Southern Cross battloids are designed very similarly, so a trained pilot can operate any of them. However, the E.B.S.I.S. battloids and the old Destroids operate differently and require separate training (each is a separate skill). The training program focuses on the piloting, not combat. Thus mecha combat for battloids must be taken, but does include all Southern Cross non-transformable battloids. **Base Skill:** 60% + 5% per level of experience.

Mecha (E.B.S.I.S.): (NEW): This skill is identical to the one before it, but applies to Soviet Battloids only. **Base Skill:** 55% + 5% per level of experience.

Mecha Combat: Each mecha, the Logan, the AJACS, Veritech Hover Tank and Battloids, have a different weapon systems and hand to hand combat aptitude. Put simply, each type handles differently than the other and requires specific training. The Logan and AJACS training is only available to T.A.S.C. while the V.H.T. training is exclusive to A.T.A.C.

Battloid piloting and mecha combat is available to most of the Armies of the Southern Cross. Its selection as a skill is the choice of the individual player. Unlike the old Destroids, Battloid hand to hand combat training includes ALL the Southern Cross battloids. (For Destroids see *ROBOTECH™ RPG*, pg 27). The specific mecha hand to hand combat abilities are listed at the very end of the skill section.

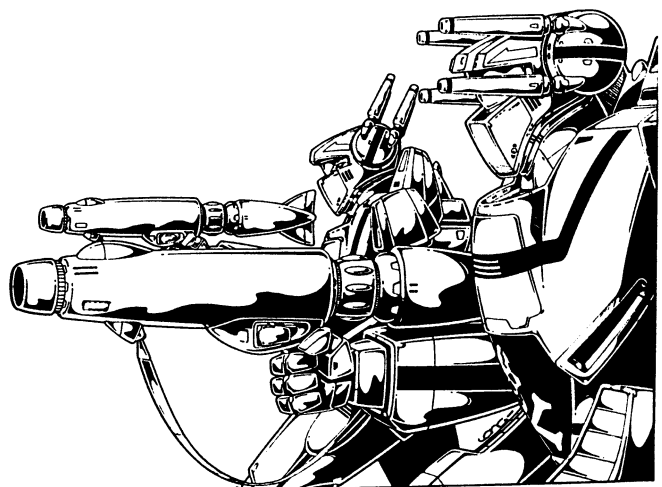

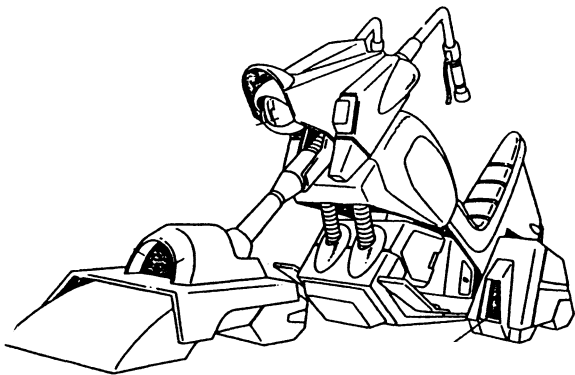

Military Hover Cycle: (NEW): The practiced skill of riding the speedy and versatile hover cycle. **Basic Skill:** 50% + 4% per level of experience.

Military Hover Vehicle: (NEW): Includes a variety of trucks, land rovers and armored vehicles carried on jets of air rather than wheels. **Basic Skill:** 60% + 4% per level of experience.

Jet Pack and Space Booster Pack: (NEW): The practiced use of the jet pack and space booster pack for aerial or space, one man flight and maneuvers. **Base Skill:** 45% + 5% per level of experience.

Motorcycle: The practiced skill of riding a motorcycle. **Base Skill:** 60% + 4% per level of experience.

Truck: Manual or automatic transmission; includes vans and trailers. **Base Skill:** 66% + 4% per level of experience.

Tank: The piloting of armored assault vehicles; includes armored all terrain vehicles, amphibious recon, and other, armored heavy vehicles and construction vehicles. **Base Skill:** 50% + 5% per level.

SPECIAL NOTE: The following rules apply to all types of automobiles, trucks, vans, motorcycles and even armored vehicles/tanks.

Special Maneuvers: Conditions and Penalties: Evasive Action:
Fleeing or dodging another vehicle, obstacle, missile or some other attack, by moving out of the way. Evasive action often involves weaving, zigzagging and sudden turns at high speeds. A successful roll means the pilot has successfully dodged out of the way. **Skill Penalty:** -15%; pilot/driver can not attack, passengers are -6 to strike in an attack. **A failed roll** means an ineffective evasive maneuver which, in turn, means the vehicle has been struck, blasted, and/or the attacker is still hot on his tracks. **THREE, CONSECUTIVE,** successful evasion rolls means the pilot has completely lost the pursuer.

Reverse Driving: This is simply driving in reverse/backward. **Skill Penalty:** -25% if driving over 65mph, and roll for each turn, swerve or evasive action. Pilot can not attack, but passengers are only -2 to strike. **A failed roll** means a minor collision.

Stunts: Include sharp turns at high speeds, sudden-on-the-dime-stops, sudden U-turns at high speeds, propelled leap (such as riding up over an incline or object, sailing 20ft in the air, land and keep on going) and similar maneuvers. **Skill Penalty:** -25%; lose all attacks that melee. **A failed roll** means the stunt is incomplete and serious difficulties encountered. Roll on the following table:

Loss of Control (Stunt and SideSwipe)

- 1-38 Minor collision; momentarily stopped; reduce vehicle's S.D.C. by 1/3; occupants shaken, but okay.
- 39-59 Stunt maneuver botched; reduce speed by half.
- 60-80 Engine or structural problems develop, requiring pilot to pull over and stop. Vehicle needs 2-12 hours of repairs.
- 81-97 Collision; vehicle is totalled; pilot and occupants receive 3D6 points of damage (subtract from hit points).
- 98-00 Collision/crash; all killed.

Sharp Curves: 90 degrees, high speed. **Skill Penalty:** -10%.

Sideswipe: This maneuver can be used against a stationary object, moving vehicle or person. The purpose of a sideswipe is to strike another vehicle, object or person, a glancing blow with the body of your vehicle. **To strike,** the swiping player rolls under his Pilot skill minus the 20% skill penalty in attempting this dangerous maneuver. **Note:** The target, if controlled by another person, can attempt to dodge via "evasive action" or "stunt" driving. **Skill Penalty:** -20%; no other attack possible. **A failed roll** to sideswipe means an automatic miss, and the player must roll under his Pilot skill, -20%, to maintain control of the vehicle. If control is lost, roll on the **Loss of Control Table** under stunts. **Damage** from a sideswipe does 2D6 for every 20 miles of speed. The sideswipe also damages the vehicle, which is equal to 1/3 the damage inflicted to the target. Thus, if the sideswipe inflicted 24 points of damage to the target, it would also do 8 points of damage to the vehicle. **Note:** The GM may substitute rules from *Road Hogs*, the TMNT supplement.

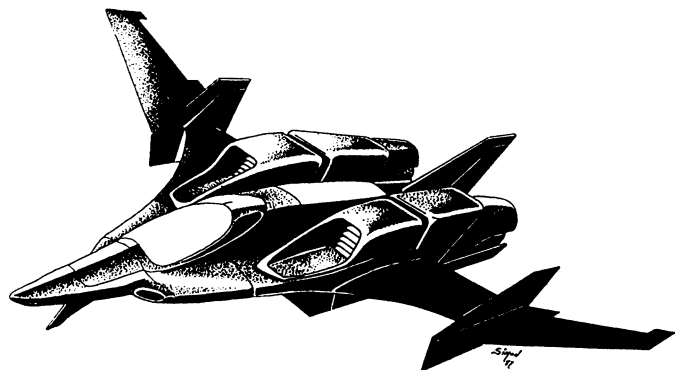

Airplane: Includes the old propeller, single and twin engine types. **Base Skill:** 70% + 4% per level of experience.

Helicopter: Includes the small, two seater, observation types; large transport and assault. **Base Skill:** 60% + 4% per level of experience.

Jet: Includes the fan jet, commercial jet and jet fighter. **Base Skill:** 60% + 4% per level of experience.

Lancer Space Fighter: **Base Skill:** 60% + 4% per level of experience.

Space Shuttle: **Base Skill:** 60% + 4% per level of experience.

SPECIAL NOTE: The following rules apply to ALL aircraft. Roll under your pilot skill for each maneuver:

Special Maneuvers: Conditions and Penalties: Evasive Action:
Fleeing or dodging another aircraft, obstacle, missile or other attack by moving out of the way. All attacks are lost while engaged in evasive action; unless something suddenly flies directly in front of the vehicle, even then the pilot is -4 to strike. **Note:** This tactic will lose any attacker(s), meaning they cannot attack unless the attacker(s) engage in a "dog tail" chase. **Skill Penalty:** -12% (no attack possible) Maneuver consumes one full melee. **A failed roll** means an ineffective evasive maneuver, attacker(s) still in strike position and/or have struck. The player's attacks are still forfeit from a failed evasive action.

Tilt Dodge: This is a difficult maneuver, in which the pilot attempts to avoid an attack by quickly tilting or jerking out of the way at the last minute. In this way, the pilot can stay on course and continue his own attacks (if any). **Skill Penalty:** -35%; -2 to strike. **A failed roll** means no dodge, aircraft is hit and takes full damage. A tilt dodge can be used to attempt to avoid each, individual attack. A tilt dodge can not avoid more than one blast from a multiple/simultaneous assault; evasive action is necessary.

Stunts: These are sudden, severe or highly difficult maneuvers, in-

cluding dives, sharp turns, dead man's drop (nearly straight down, high speed drop), tumble, somersault and similar actions. **Skill Penalty:** -30%; lose attacks that melee. **A failed roll** means the stunt is incomplete and serious difficulties encountered. Roll percentile dice on the following table:

- 1-40 Engine chokes, stalled out and descending; must make an emergency landing unless the vehicle can be restarted (Pilot skill -25%; can try once every melee). All attacks are defensive only, -4 to strike.
- 41-70 Stunt maneuver botched, speed and altitude reduced by $\frac{1}{3}$.
- 71-88 Engine difficulties; forced to make an emergency landing. Repairs will require 4-24 hours.
- 89-00 Engine and/or vehicle damaged beyond repair, crash inevitable. Character must parachute to safety. Optional: Can direct vehicle on a suicide crash into an immediate target; Pilot skill, -20%, to strike.

Emergency Landing: Executed when the vehicle or pilot is damaged and flight can not be maintained. **Skill Penalty:** -30%; loses all attacks. **A failed roll** will result in a crash landing. Roll on the following table for Crash Landing:

- 1-31 Pilot and/or passengers survive, minor injury.
- 32-57 Crash; pilot and passengers take 5D6 damage.
- 58-80 Pilot and passengers in critical condition/coma, require immediate, extensive medical treatment. Treat as surviving death and coma.
- 81-83 No survivors; vehicle exploded.
- 84-00 Passengers survive with minor injury, pilot dead. Optional: Pilot can opt to parachute to safety rather than attempting a landing.

Shadow: Is a maneuver in which the air vehicle pursues another vehicle without detection. This is usually done by flying above and behind the pursued, using clouds as cover. The pursuer will mimic the vehicle pursued in every way, so that they will be thought to be a radar shadow or aberration. **Skill Penalty:** -20%; no attacks possible without revealing true position and nature. While imitating the evasive actions, stunts, and so on of the craft being shadowed, roll for each maneuver being copied.

Dog Tail: This is an offensive maneuver in which the pilot closely pursues an enemy air vehicle while locked in combat. This is the only maneuver that can pursue a vehicle taking evasive action. By hanging on the enemy's tail or "dog tailing", the attacker can usually strike with little or no fear of counter-strike. **Skill Penalty:** -15%; no strike penalty. **A failed roll** means the target has momentarily slipped out of the striking range/area. Roll once every other melee to maintain dog tail position, *or* for every evasive or stunt action.

Boats: Sail Type: Base Skill: 80% + 4% per level of experience.

Boats: Motor Type: Large and small (not ships). **Base Skill:** 70% + 4% per level of experience.

PILOT RELATED SKILLS

Navigation: Skills in map reading, star charts, course computation, following landmarks, and use of navigational equipment. Includes air, land and water navigation, as well as piloting by instruments alone. **Note:** Basic mathematics and read sensory equipment are required to navigate. **Base Skill:** 60% + 5% per level of experience. A failed roll means the pilot is off course. Roll $2D6 \times 100$ for aircraft, $4D6 \times 100$ for Veritech Fighters, and $1D6 \times 100$ for land vehicles, to determine how many miles/kilometers they are off course by. Roll for every hour that one is off course.

Navigation - Space: Basically the same as normal navigation techniques. The only difference is the use of stars, and some of the sensory equipment. **Base Skill:** 60% + 5% per level of experience.



Sensory Equipment: Individuals with this training can maintain, understand, operate, and "read" or interpret sensory data from all types of conventional sensor devices. These devices include radar, sonar, motion detectors, surveillance equipment, optical enhancement, instrument panels and so on. **Base Skill:** 40% + 5% per level of experience. **Note:** Characters without a sensory skill cannot understand nor operate air vehicles, radar or detection/surveillance equipment.

Weapon Systems: This is the complete understanding of weapon units and systems incorporated in *vehicles* and *Mecha*. It includes the Battloids, vast variety of weapons, lasers, particle beams, auto cannons, missile launchers, and so on. **Special Bonus:** +2 to strike. This does not include hand-held weapons which require individual, W.P. training. **Note:** Characters without weapon systems skill will be able to operate them only if skilled in piloting that vehicle (like Pilot Mecha or Helicopter, etc.), but has no bonus to strike and never have the initiative. **Base Skill:** 60% + 5% per level of experience, and represents the overall comprehension and ability of the character.

SCIENCE

Astrophysics: Knowledge of stellar astronomy and how it relates to nuclear physics, quantum mechanics, relativity, and other explanations for the creation of deep space phenomena, like quasars and black holes. **Note:** Basic and advanced Mathematics is required before taking Astrophysics. **Base Skill:** 30% + 5% per level of experience.

Biology: Basic understanding of cells, anatomy, physiology, evolution and genetics. The character will know the basic use of a microscope, cultivating bacteria and how to classify new organisms. **Base Skill:** 40% + 5% per level of experience.

Botany: Plants, their categories and functions, are studied extensively. Characters will know the basics of cross-fertilization, germinating and growing experimental plants. **Base Skill:** 40% + 5% per level of experience.

Chemistry: Basic understanding of chemical principles and formulae. Characters know enough chemical laboratory procedures for analyzing and synthesizing chemical compounds in order to be competent assistants. **Base Skill:** 60% + 5% per level of experience.

Chemistry - Analytical: Chemical engineering theory, useful in the analysis of compounds and their practical applications. Characters will be highly skilled in the use of laboratory equipment, and can analyze and synthesize chemicals. **Note:** Basic and advanced Mathematics are prerequisites. **Base Skill:** 50% + 5% per level of experience.

Mathematics – Basic: Includes basic addition, subtraction, multiplication, division, fractions and algebra. **Base Skill:** 80% + 4% per level of experience.

Mathematics – Advanced: Includes geometry, trigonometry, calculus and techniques for advanced mathematics. **Base Skill:** 64% + 4% per level of experience.

TECHNICAL

Computer Operation: A knowledge of how computers work, along with the skills to operate peripherals like keyboards, printers and modems. Characters can follow computer directions, enter and retrieve information, and similar, basic, computer operations. However, this does NOT include programming. **Base Skill:** 60% + 5% per level of experience.

Computer Programming: Designing, programming, debugging, and testing computer programs/software. **Note:** Computer Operation is required before taking computer programming. **Base Skill:** 40% + 5% per level of experience.

Demolitions: Demolitions provides the person with an advanced knowledge in the use and workings of explosives and detonation devices, for the purpose of blowing up bridges, buildings and sabotage. This includes *all* types of explosives, such as mines, dynamite, plastics, nitro, blasting caps, etc. It also includes a basic understanding of the strategic placement of mines and booby traps. This will increase a character's awareness of suspicious rope, string and wire. **Base Skill:** 60% + 5% per level of experience. A failed roll means a dud; no explosion.

Demolitions Disposal (or Explosive Ordnance Disposal): This skill enables the character to safely defuse unexploded mines, bombs, explosive booby traps, dud artillery rounds, dud explosive charges, or any other explosive device. **Base Skill:** 60% + 5% per level of experience. A failed roll means the item has exploded without warning.

Photography: Taking black and white or color, still pictures. Characters will know how to load, develop and enlarge film. **Base Skill:** 50% + 5% per level of experience.

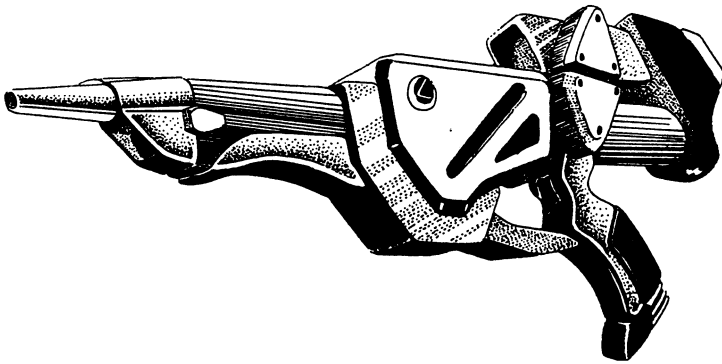

WEAPON PROFICIENCIES

There are two categories of weapon proficiencies (W.P.): Ancient and modern.

Ancient Weapon Proficiencies: Each skill area provides combat training with a particular type of weapon. The result is hand to hand combat bonuses to strike and parry, but only when that weapon is used. Each W.P. counts as one skill. The character may select several W.P. **Note:** Characters without a W.P. CAN use any weapon, but without bonuses.

W.P. Blunt: A skill with any type of blunt weapon including mace, hammers, cudgels, pipe, staff and clubs. **Bonuses:** +1 to strike and parry at **level one**, add another +1 to strike and parry at **level four** and +1 to parry at **level eight**.

W.P. Chain: Includes ordinary lengths of chain, mace and chain, flail, nunchaku, etc. **Bonuses:** +1 to strike at **level one**, add another +1 to strike and parry at **level four** and +1 to parry at **level eight**.

W.P. Knife: Combat skill with all types of knives. **Bonuses:** +1 to strike when thrown, **level one**; +1 to strike and parry at **level two**, +1 to parry at **level five**, +1 to strike at **level six** and again at **level nine**.

W.P. Sword: Combat skill with large and small swords. **Bonuses:** +1 to strike and parry at **level one**; an additional +1 to strike and parry at **level four**, and again at **level eight**.

Modern Weapon Proficiencies: These are areas of training and practiced skills with a particular type of modern weapon. Each W.P. counts as one skill. Characters may have several W.P. Each provides a bonus to strike. See the Combat Section for details.

MODERN WEAPON PROFICIENCIES

The system for modern weapons presented in **Heroes Unlimited** and **Teenage Mutant Ninja Turtles & Other Strangeness** are fairly accurate and effective rules. However, they tend to bog down the speed of play with numerous dice rolls for damage and time determining how many rounds fired actually strike. I've since developed a quick playing, alternative set of rules, which appears for the first time in a formal, large press publication. (The same rules saw print earlier this year in a special, promotional pamphlet). Game masters should feel free to substitute these rules if they prefer, with those from, the previously mentioned game books or even those from the **Revised RECON**. All are modern weapon rules that would work just as well in **ROBOTECH®**.

Weapon Proficiencies (W.P.) are areas of training and practiced skill with a particular type of weapon, such as revolver or sub-machinegun. This skill provides special bonuses to strike when using that weapon. Do not add this strike bonus to your character's hand to hand or Mecha combat skill bonuses to strike.

Weapon Proficiencies provide the following bonuses:

Aimed: +3 to strike.

Burst: +1 to strike.

Wild: No bonus or penalty.

Training also enables the character to easily reload, disassemble, unjam, clean and otherwise maintain the weapon. **Recognizes weapon quality** — 30% at **level one** and +6% per each additional level of experience. **Add a bonus** of +1 to strike for every **THREE** levels of experience beyond level one. When firing a weapon, there are three main modes or categories of attack; *aimed, burst or wild*.

AIMED

An **aimed shot** means a person takes the time to carefully aim and squeeze off one, well placed shot. Each individual shot takes one full attack. Thus, if a character has four attacks per melee he/she can shoot **FOUR** aimed shots. This applies to all weapons. Roll to strike for each shot.

Bonus to Strike is +4 with a revolver or +3 for all others.

BURST

A **burst** is the shooting of several rounds, immediately one after another. Aim is more hasty and the recoil moves the weapon with each shot, reducing the accuracy. Semiautomatic/automatic weapons, machineguns and sub-machineguns, are designed for burst firing. The concept is that, while accuracy is reduced, the odds of hitting one's target with multiple rounds is increased because more shots are fired. **Bonus to Strike** is +1 with all weapons.

Note: Roll to strike once to see if the entire burst hits. Do not roll for each individual bullet. If the burst misses its target, then all the rounds in that burst miss.

Short bursts fire 20% of the entire round magazine; i.e., 30 round magazine — 6 rounds/bullets are fired. **Damage:** Roll the normal damage dice for **ONE** round × 2. Uses up one attack. Can be fired at only one target.

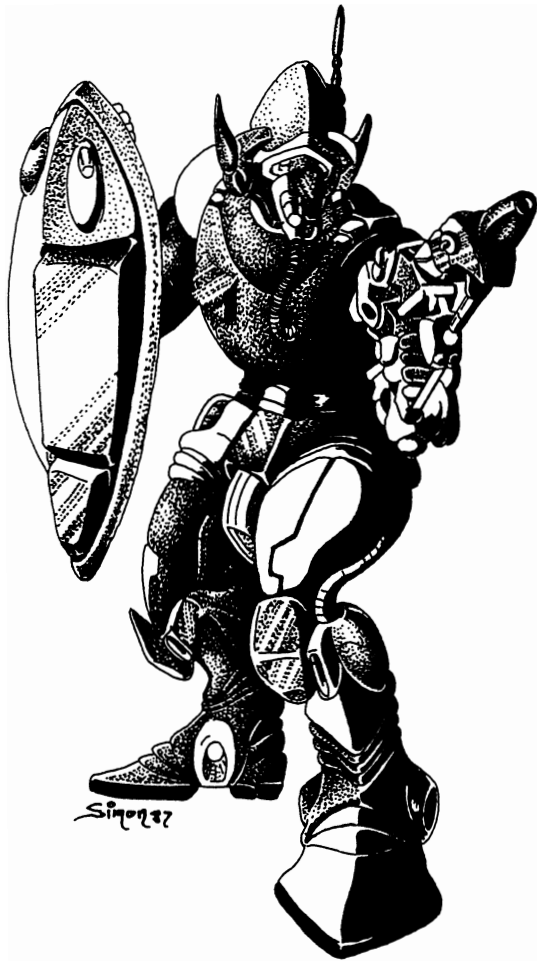

Long burst fires 50% of the entire round magazine; i.e., 30 round magazine — 15 rounds/bullets are fired. **Damage:** Roll the normal damage dice for ONE round $\times 5$. Uses up one attack. Can be fired at only one target.

Entire magazine: Shooting off the entire clip/magazine within a melee round is possible. 100% of the rounds are fired. **Damage:** Roll the normal damage dice for ONE round $\times 10$. Uses up *two* attacks that melee. Can be fired at only one target. Machineguns are the only exception to this rule.

Spray: Shooting a burst at several targets at once is possible, but the same as shooting wild. You must fire a *long burst* or an *entire magazine* in order to spray. See shooting wild.

SHOOTING WILD

Shooting wild occurs when a trained character shoots without taking time to aim. This usually applies when the person is blinded, angry, running, rolling, leaping, shooting from a moving vehicle, etc.

Bonus to Strike: With W.P. there is no bonus or penalty; with no W.P. the person strikes at -6 . Long bursts or the entire magazine must be fired. Counts as two attacks. Can be fired at one target or in a spray. **Damage for shooting wild at one target:** Roll normal damage dice for ONE round $\times 2$. Roll once to strike with the wild burst. **Hitting an innocent bystander** is a real possibility when shooting wild; 20% chance. Roll for each wild burst fired. **Damage** is the normal damage from one round (a wild shot).

Spray an area with bullets can be dangerous and is considered to be shooting wild. The object of a spray is to hit several targets simultaneously. **First**, roll once to determine if you strike the target area; 1D20; 5 or higher strikes as usual. Then roll 1D4 to determine how many individual targets are struck within the target area. However, each target gets a roll to dodge to avoid getting shot. **Damage** is the normal damage from one round. **Hitting an innocent bystander** is even

more likely; 50% chance. Damage is from one round, wild shot.

Bursts or Sprays from a machinegun is different only in the number of rounds fired, targets struck, and chance of hitting a bystander. Machineguns have a much greater ammunition capacity, so it does not have to empty the same percentage of its entire clip.

Short burst/one target: 10% of rounds magazine; inflicts normal round damage $\times 2$. Counts as one attack.

Short burst spray: 10% of rounds magazine; inflicts normal damage from ONE round, hits 1D4 targets.

Long burst/one target: 30% of rounds magazine; inflicts normal damage $\times 5$. Counts as one attack.

Long burst spray: 30% of rounds magazine; inflicts normal damage from ONE round, hits 1D8 targets. Counts as one attack.

Empty the entire magazine/one target: All rounds fired; inflicts normal round damage $\times 20$. Counts as all melee attacks/one full melee.

Empty the entire magazine in a spray: All rounds fired; inflicts normal round damage $\times 2$, hits 2D8 targets. Counts as ALL melee attacks/one full melee. Chance of hitting innocent bystanders is 70%.

A Special Note About Shotguns:

Shotguns can fire once or twice per melee (double-barrel). It can fire both rounds simultaneously or one at a time. Buckshot scatters, and will strike the specific target plus 1D4 others within its blast area (approximately a 15ft/4.6m area).

Note: *Conventional Weapons* will do absolutely NO DAMAGE to Mecha or mega-structures (M.D.C.), even if the combined damage from a burst is over 100 S.D.C. Only weapons that inflict mega-damage (M.D.) can damage a mega-structure.

HAND TO HAND: BASIC

- Level 1** Two attacks per melee; +2 to pull/roll with punch, fall or impact.
- 2 +2 to parry and dodge.
 - 3 Kick attack does 1D6 points damage.
 - 4 One additional attack per melee.
 - 5 +1 to strike.
 - 6 Critical strike on an unmodified roll of 19 or 20.
 - 7 +2 to damage.
 - 8 Judo-style body throw/flip; does 1D6 damage, and victim loses initiative and one attack per melee.
 - 9 One additional attack per melee.
 - 10 An additional +2 to pull/roll with punch, fall or impact.
 - 11 An additional +1 to parry and dodge.
 - 12 An additional +1 to strike.
 - 13 Critical strike or knockout from behind.
 - 14 An additional +2 to damage.
 - 15 An additional attack per melee.

HAND TO HAND: EXPERT

- Level 1** Two attacks per melee; +2 to pull/roll with punch, fall or impact.
- 2 +3 to parry and dodge.
 - 3 +2 to strike.
 - 4 One additional attack per melee.
 - 5 Kick attack does 1D6 damage.
 - 6 Critical strike on an unmodified roll of 18, 19 or 20.
 - 7 Paired weapons.
 - 8 Judo-style body throw/flip; does 1D6 damage, and victim loses initiative and one attack.
 - 9 One additional attack per melee.
 - 10 +3 to damage.
 - 11 Knockout/stun on an unmodified roll of 18, 19 or 20.
 - 12 An additional +1 to parry and dodge.

- 13 Critical strike or knockout from behind (triple damage).
- 14 An additional attack per melee.
- 15 Death blow on a roll of natural 20.

HAND TO HAND: MARTIAL ARTS

- Level 1** Two attacks per melee; +3 to pull/roll with punch, fall or impact.
- 2 +3 to parry and dodge; +2 to strike.
 - 3 Karate-style kick does 1D8 damage.
 - 4 One additional attack per melee.
 - 5 Jump kick (critical strike).
 - 6 Critical strike on an unmodified roll of 18, 19 or 20.
 - 7 Paired weapons.
 - 8 Leap attack (critical strike).
 - 9 One additional attack per melee.
 - 10 Judo-style body throw/flip; does 1D6 damage, victim loses initiative and one attack.
 - 11 An additional +4 to damage.
 - 12 An additional +2 to parry and dodge.
 - 13 Knock-out/stun on an unmodified roll of 18, 19 or 20.
 - 14 An additional attack per melee.
 - 15 Death blow on a roll of a natural 20.

COMBAT TERMS

A.R.: This is a character's **Armor Rating**. The A.R. indicates what an attacker must roll in order to do damage to the character. Any roll of 5 or better, will strike a character with no body armor. Characters with **Artificial Body Armor**, metal armor, bulletproof vests, etc., can easily be successfully attacked by rolls falling under the artificial armor's A.R.; doing damage to the S.D.C. of the *body armor*, but not to the S.D.C. of the defender. Or, by striking above the armor's A.R., damaging the character's personal S.D.C. and/or hit points. **Example:** A defender has a natural A.R. of 5 and is wearing body armor with an A.R. of 8. If the attacker rolls 9 or better, then damage is done directly to the defender. A roll of 5, 6, 7, or 8, would only hurt the body armor, not the wearer. A roll of 1, 2, 3, or 4, would totally miss.

Damage Table (Basic)

Human Fist	1D4
Human Kick	1D6 or 1D8
Black Jack	1D6
Bull Whip	1D8
Thrown Small Objects	1D4
Falling	1D6 per 10ft
Collision	1D8 per 10mph
Smashing through Glass	1D4
Dropped or Thrown	
Large Objects	1D8 per 100lbs 1D8 per 40ft, and 1D4 per 4mph

Death Blow: An automatic kill. The defender can try to roll with death blow by rolling over the attacker's strike. If the defender is not killed, then the current S.D.C. and hit points are reduced to half. This attack is available only under certain conditions.

Dodge: A character dodges by moving out of the way of the attack. Dodging always takes up one attack/action per melee round. To Dodge, the defender must roll higher than the attacker's strike roll on a twenty-sided die.

Entangle: A defender can attempt to trap the weapon or arm of an attacker. This is done instead of parrying or dodging, and takes up one attack per melee. An entangle is successful if the defender rolls

above the attacker's strike roll. It takes one attack and a roll to entangle to keep an opponent's arm or weapon entangled every melee round. In order to get free, the entangled opponent must roll a dodge against the entangle roll.

Hand to Hand Combat: Fighting skills that provide the characters with attacks per melee, bonuses, and techniques. Characters without combat training have only one attack per melee and have *no* automatic chance to parry.

Hit Points: This is the number of points of damage a character can take before dying. Characters don't lose hit points until their S.D.C. is down to zero. A character's base hit points is the P.E. plus 1D6. Another 1D6 of hit points is gained every time the character advances an experience level. Lost hit points are not recovered without medical attention.

Initiative: Whoever gets to attack first is considered to have the Initiative. Initiative is automatic in sneak attacks and long range attacks. In most other cases, each opponent rolls a twenty-sided, highest roll gets the initiative. Rolling for initiative takes place at the beginning of each melee round of combat.

Kick Attack: This is a karate-style kick. It is a normal attack that does 1D4 damage for the untrained, or higher with hand to hand skills. Anyone trained in hand to hand combat can do a kick attack.

Knockout/Stun: Anyone hit by a knockout or stun attack will be temporarily incapacitated. The victim is not necessarily unconscious, just dazed.

Jump Kick: A Jump Kick is performed by leaping completely off the ground and attempting to land foot-first on an opponent. Jump Kick can be used only by those skilled in hand to hand martial arts. The advantage of a jump kick is that it works as a *critical strike* and doubles the normal damage inflicted. The disadvantage of a jump kick is that no other attack may be performed in that melee round (all attacks for that melee are used up in the kick). The jump kick must be the character's first attack of that melee round. For the rest of the melee round, the character can only parry, dodge or move into position.

Leap Attack: An airborne assault where the weapons and fists are wielded in mid-leap. A leap attack must be made only at the beginning of a melee round and, like the jump kick, uses up *all* attacks for that melee. Usually, only a single strike can be made during a leap attack. However, if two opponents are close together, the attacker can leap between them and strike both of them at the same time; roll to strike for each character. After the leap, the character may not attack again until the next melee round, but can parry or dodge or move into position. Automatic parries work in mid-leap, but dodges are impossible. A successful leap attack is a critical strike and does double damage.

Long-Range Attack: By using a long-range weapon from a distance, an attacker can perform an undetected, *first strike*. Provided the attacker is not seen, the defender automatically loses initiative and may not dodge the first attack that melee round.

Melee or Melee Round: Exactly 15 seconds. The segment of time combatants have to strike, counter and/or return strike. Generally, playing characters have two or more attacks per melee.

Multiple Attackers: Takes place when an opponent is faced by more than one attacker. Characters with hand to hand combat skills can attempt to parry any attacks within their line of sight. The defender from multiple attackers can strike at only one target at a time (see leap attack for a rare exception).

Natural Twenty: This is the result of 20 when rolling a twenty-sided die. A strike with a natural twenty will always be a critical strike. If someone with a strike bonus of +2 rolls an 18, then they have an attack roll of 18 *plus* unnatural, bonus modification; NOT a natural twenty, and is not a critical strike. A natural twenty beats all other rolls and can only be parried or dodged by *another natural*

twenty.

Paired Weapons: Certain kinds of weapons, such as Sais, Nunchaku, knives, clubs and swords, can be used as paired weapons. Users of paired weapons can strike and parry simultaneously, can do twin strikes against a single target or against a pair of targets, and can parry two, different opponents at the same time. In other words, warriors skilled in paired weapons often can do two actions for every one of their melee attacks. BUT, every time they use twin actions they LOSE their automatic parry.

Parry: A defender can attempt to parry most physical attacks. This is done by blocking the attacker's blow with a weapon or hand. Characters trained in hand to hand combat can parry without losing melee attacks. Bullets and energy attacks *cannot* be parried!

Pull Punch: The ability to control the force of a hand to hand attack. Usually used to reduce the blow to less than killing force. The character can choose to half damage, quarter damage, a single point or no damage at all. A character must declare a pulled punch, the player must roll 11 or better on a twenty-sided die; failure means full damage is inflicted.

Roll with Punch/Fall: Hand to Hand combat fighters can reduce the damage from blows and falls by rolling. If the defender is successful, then only half damage is taken. Roll with punch/fall does not work against energy blasts, bullets, fire, bladed weapons, psionics or radiation. Victims must roll higher than the attacker's roll. *Falling* characters must roll a 14 or higher, on a twenty-sided die, to roll with the fall.

Saving Throws: Occasionally, characters must roll to save against exotic attacks like poison, gas, insanity, psionics, etc.

Lethal Poison	14 or better
Non-lethal Poison	16 or better
Harmful Drugs	15 or better
Acids	No save possible — Dodge!
Insanity	12 or better
Psionics	15 or better for non-psionics 10 or better for psionic

S.D.C.: This stands for *Structural Damage Capacity*, which is the amount of damage an object can absorb before breaking. Living creatures also have S.D.C.; it represents their physical resistance to damage. All the S.D.C. of a living thing must be reduced to zero before the hit points can be affected. Note: A cousin to S.D.C. is M.D.C. or Mega-Damage Capacity. M.D.C. applies to Mecha, and is explained in the Mecha Combat section which follows shortly.

S.D.C. Table (Basic)

Below are the S.D.C. values for a variety of objects. When an object's S.D.C. is reduced to zero, it is considered broken. Game masters should exercise common sense in applying these values. For example, a normal human cannot break through a vault door with bare fists, no matter how many times natural twenties are rolled.

The S.D.C. of different weapons is applied *only* if someone is actually attempting to break the weapon. A properly wielded sword can inflict or parry many times its S.D.C. On the other hand, using the sword to wedge open a door could easily snap it off.

It is also important to note that the S.D.C. applies to the entire object. A bullet can penetrate many objects with only a small fraction (about 2%) of S.D.C. loss. For example, if a bullet punching through an exterior brick wall hit a target, it would inflict normal damage minus the 4 points of S.D.C. it wasted getting through the wall.

Airplane, Single Engine	400 S.D.C.
Airplane, Jet Airliner	2000 S.D.C.
Boat, Canoe/Rowboat	40 S.D.C.
Boat, Cabin Cruiser	450 S.D.C.
Boat, Cargo Freighter	8000 S.D.C.
Box, Cardboard	2 S.D.C.
Box, Wood Shipping Crate	12 S.D.C.

Box, Metal Shipping Crate	48 S.D.C.
Car, Compact	250 S.D.C.
Car, Luxury	450 S.D.C.
Car, Door Only	150 S.D.C.
Car, Windshield Only	100 S.D.C.
Door, Interior Wood	100 S.D.C.
Door, Exterior Wood	170 S.D.C.
Door, Metal Grill	350 S.D.C.
Door, Solid Metal	600 S.D.C.
Door, Metal Safe	800 S.D.C.
Door, Bank Vault	5000 S.D.C.
Handcuffs, Regular	60 S.D.C.
Handcuffs, Heavy	120 S.D.C.
Lock, Common Latch	40 S.D.C.
Lock, Dead Bolt	100 S.D.C.
Lock, Heavy Padlock	75 S.D.C.
Motorcycle	100 S.D.C.
Truck, Medium Sized Pick-up	450 S.D.C.
Truck, Half-Ton Pick-up	550 S.D.C.
Truck, Freight Hauler	650 S.D.C.
Wall, Interior Plaster	120 S.D.C.
Wall, Exterior Wood	150 S.D.C.
Wall, Exterior Brick	200 S.D.C.
Wall, Cinder Block	300 S.D.C.
Wall, Reinforced Concrete	400 S.D.C.
Weapon, Hard Wood	40 S.D.C.
Weapon, Metal Sword	100 S.D.C.
Weapon, Small Pistol	35 S.D.C.
Weapon, Assault Rifle	75 S.D.C.
Weapon, Artillery Piece	1500 S.D.C.
Window, Ordinary Glass	20 S.D.C.
Window, Plexiglass	35 S.D.C.

Simultaneous Attack: Instead of defending with a parry, dodge or entangle, a character can choose to do a simultaneous attack. In this case, the character does not defend ("Go ahead, hit me; I can take it!") and simply attacks in response. The advantage of a simultaneous attack is that *neither* opponent can parry, dodge or entangle. In all probability, both will take damage. *Exception:* An opponent with paired weapons can engage in simultaneous attack (with one weapon) AND parry (with the other), OR, both the paired weapons can be used to strike with NO parry.

Sneak Attack: An attacker may lie in wait (ambush), attack from behind, or sneak up (prowl) on an opponent. If the foe does not discover the attacker, then the sneak attack is successful. The sneak attacker always has initiative, and the defender is not able to parry or dodge the sneak attack.

Strike: Anyone attempting to hit an opponent must roll to strike. As with all combat rolls, a roll to strike is made with twenty-sided dice.

Throw: Simply, this means throwing a weapon. Rolling to throw is exactly the same as rolling to strike, except that there are different bonuses per weapon type. See Weapon Proficiency.

NOTE: A character may use ANY type of weapon, but gets no combat bonuses, such as strike or parry, unless he has a Weapon Proficiency (W.P.) in that particular weapon. This applies to modern and ancient weapons.

DETERMINING PHYSICAL S.D.C.

Each O.C.C. provides a *base* physical S.D.C. from training. R.E.P. — 40, H.C.O.S. — 35, G.M.P. — 30, T.C. — 30; A.T.A.C. — 30, D.S. — 30, the T.A.S.C. and all the other O.C.C.s get a base S.D.C. of 25. Additional physical S.D.C. are gained from physical skills, such as boxing. *All S.D.C. points are accumulative.*

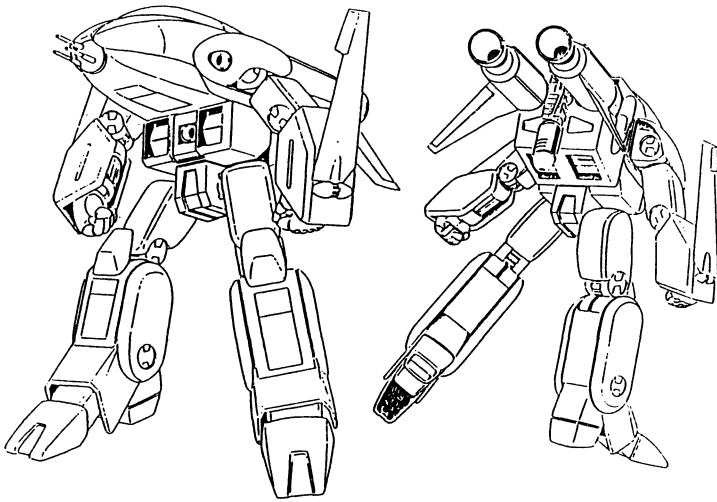

HAND TO HAND BONUSES FROM LOGAN COMBAT TRAINING

- 2 hand to hand attacks per melee (plus those of the pilot).
- +2 to roll with punch, fall or impact (explosion), reducing damage by half.
- +1 to strike.
- +3 to parry with arm shields.
- +4 to dodge in Guardian mode; +6 to dodge in jet mode.
- Kick attack
- Body block/tackle/ram (roll to strike as normal).
- Critical strike's same as pilot's hand to hand.
- One, additional hand to hand attack at level five.
- One, additional hand to hand attack at level ten.

Damage: **Punch** 1D4 M.D. in Guardian mode.

Body Block 1D6 M.D.

Kick 1D4 M.D.

Remember, these bonuses are in addition to the pilot's own hand to hand training and attribute bonuses. The mecha bonuses do *not* apply to the pilot's physical abilities outside the mecha. **Note:** All Southern Cross mecha are laser resistant, thus lasers do half damage. This does not include other energy attacks.

HAND TO HAND BONUSES FROM AJACS COMBAT TRAINING

- 3 hand to hand attacks per melee (plus those of the pilot).
- +2 to roll with punch, fall or impact (explosion), reducing damage by half.
- +2 to strike.
- +2 to parry (no arm shields, so can not parry blasts).
- +2 to dodge in battloid mode, +4 to dodge in helicopter mode in atmosphere, +6 in space.
- Reduce the previous bonuses by half when fighting in an atmosphere.
- Power punch: special
- Kick attack
- Body block/tackle/ram (roll to strike as normal).
- Critical strikes same as pilot's hand to hand.
- Leap kick attack.
- One, additional hand to hand attack at level six.
- One, additional hand to hand attack at level eleven.

Damage: **Restrained Punch** — 1D4 M.D.

Full Strength Punch — 2D4 M.D.

Power Punch — 3D4 M.D.

Body Block/Tackle — 2D4 M.D.

Body Flip — 1D4 M.D.

Kick — 1D6 M.D.

Stomp — 1D4 M.D.*

Tear or Pry with hands — 1D4 M.D.

*Effective only against small objects (10ft or smaller).

Remember, these bonuses are in addition to the pilot's own hand to hand training and attribute bonuses. The mecha combat bonuses do *not* apply to the pilot's physical abilities outside the giant machine. **Note:** All Southern Cross mecha are laser resistant, thus lasers do half damage. This does not include other energy attacks.

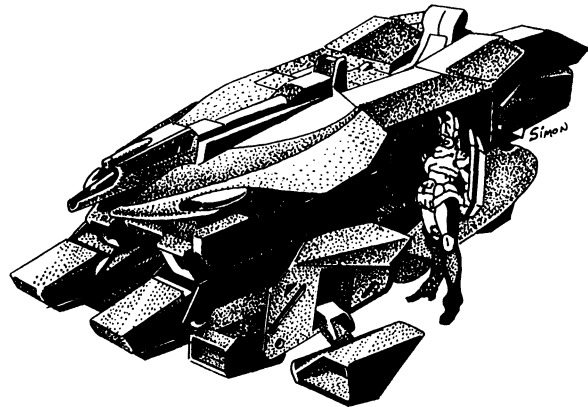

HAND TO HAND BONUSES FROM HOVER TANK COMBAT TRAINING

- 3 hand to hand attacks per melee (plus those of the pilot).
- +3 to roll with punch, fall or impact (explosion), reducing damage by half.
- +1 to strike.
- +3 to parry with arm shields.
- +1 to dodge.
- Body block/tackle/ram (roll to strike as normal).
- Critical strike's same as pilot's hand to hand.
- Body flip/throw; 1D4 M.D. damage plus victim *loses* initiative and one attack that melee. Possible only in Battloid mode.
- Kick attack.
- Leap kick attack.
- Power punch; +6 mega-damage (M.D.).
- Critical strikes same as the pilot's hand to hand.
- One, additional hand to hand attack at level six.
- One, additional hand to hand attack at level eleven.

Damage: **Restrained Punch** — 1D4 M.D.

Full Strength Punch — 2D6 M.D.

Power Punch — 2D6 + 6 M.D.

Body Block/Tackle — 1D6 M.D.

Body Flip — 1D4 M.D.

Kick — 1D6 M.D.

Leap Kick — 2D6 M.D.

Stomp — 1D4 M.D.*

Tear or Pry with hands — 1D4 M.D.

*Effective only against small objects (10ft or smaller).

Remember, these bonuses are in addition to the pilot's own hand to hand training and attribute bonuses. The mecha bonuses do *not* apply to the pilot's physical abilities outside the giant machine.

HAND TO HAND BONUSES FROM BATTLOID COMBAT TRAINING

- 2 hand to hand attacks per melee (plus those of the pilot).
- +2 to roll with punch, fall or impact (explosion), reducing damage by half.
- +1 to strike.
- +3 to parry with arm shields.
- +2 to dodge.
- Body block/tackle/ram (roll to strike as normal).
- Body flip/throw; 1D4 damage plus victim *loses* initiative and one attack that melee.
- Kick attack
- Leap kick attack.
- Critical strikes same as pilot's hand to hand.
- One, additional hand to hand attack at level five.
- One, additional hand to hand attack at level ten.

Damage: Restrained Punch 1D4 M.D.

Full Strength Punch — 2D4 M.D.

Body Block/Tackle — 2D4 M.D.

Body Flip — 1D4 M.D.

Kick — 1D6 M.D.

Leap Kick — 2D6 M.D.

Stomp — 1D4 M.D.*

Tear or Pry With Hands — 1D4 M.D.

*Effective only against small objects (10ft or smaller).

Remember, these bonuses are in addition to the pilot's own hand to hand training and attribute bonuses. The mecha bonuses do *not* apply to the pilot's physical abilities outside the mecha. **Note:** All Southern Cross mecha are laser resistant, thus lasers do half damage. This does not include other energy attacks.

HAND TO HAND BONUSES FROM E.B.S.I.S. BATTLOID TRAINING

- 2 hand to hand attacks per melee (plus those of the pilot).
- +1 to roll with punch, fall or impact (explosion), reducing damage by half.
- +1 to strike.
- +1 to parry and dodge. Note: Lack of arm shields means the E.B.S.I.S. battloids can not parry projectiles or energy blasts.
- Kick attack.
- Body block/tackle/ram (roll to strike as normal).
- Body flip/throw; 1D4 damage plus victim loses initiative and one attack that melee.
- Critical strikes same as pilot's hand to hand.
- One, additional hand to hand attack at level five.
- One, additional hand to hand attack at level ten.

Damage: Restrained Punch 1D4 M.D.

Full Strength Punch — 2D4 M.D.

Body Flip — 1D4 M.D.

Body Block/Tackle — 2D6 M.D.

Kick — 1D6 M.D.

Stomp — 1D4 M.D.*

Tear or Pry — 1D4 M.D.

*Effective only against small objects (12ft or smaller).

Remember, these bonuses are in addition to the pilot's own hand to hand training and attribute bonuses. The mecha combat bonuses do *not* apply to the pilots physical abilities outside the mecha. **Note:** The Soviet mecha is NOT laser resistant and takes full damage from all energy weapons. The use of Soviet mecha is so different from the Southern Cross battloids that one pilot can not operate the other.

OPTIONAL RULES

Optional Ways to Round Out Your Character

I've found that many players like as much background and details about their characters as possible. Consequently, I've assembled a series of optional tables to satisfy those details. All tables require the roll of percentile dice.

Age

I think it's best to generally assume most characters are young; late teens to mid-twenties.

1-30 Late Teens (16, 17, 18 or 19)

31-60 Early Twenties (20-22)

61-80 Mid-Twenties (23-25)

81-00 Late Twenties (26-28)

Weight

1-20 Skinny

21-40 Average

41-60 Husky

61-80 Potbelly

81-00 Obese

Note: Average weight:

150 to 180lbs, male

110 to 140lbs, female

Height

1-30 Short

31-70 Average

71-00 Tall

Note: Average height:

6ft, male

5ft 6in, female

Land of Origin

1-18 Asia

19-37 Europe

38-60 North America

61-75 South America

76-89 Mars Base

90-00 Moon Base

Relationship to the Other Characters

(Roll for each character in the group)

1-15 Brother or sister.

16-25 No relationship developed yet.

26-42 Friends.

43-50 Finds him or her irritating, but basically okay.

51-60 Old classmates (school or military).

61-70 No relationship yet developed.

71-85 Dislikes the other.

86-96 Cousins

97-00 Friends

Birth Order

1-30 First Born

31-60 Second Born

61-90 Last Born

91-00 Illegitimate

Family Ties: Parents

1-10 Died in the Zentraedi global assault.

11-20 One died in the civil war; 1-50 father, 51-00 mother.

21-50 Both are alive and well.

51-60 One died from the elements; 1-50 father, 51-00 mother.

61-70 Both died in civil war; 1-50 father, 51-00 mother.

71-80 One killed by rogue Zentraedi, 1-50 father, 51-00 mother.

81-90 One killed by bandits; 1-50 father, 51-00 mother.

91-00 Orphan, never knew your parents.

Disposition

1-10 Hate Zentraedi, very prejudiced, distrust all aliens.

11-15 Shy, timid, tends to be a loner.

16-20 Gung-ho, guts and glory type who sees self as a hero. Likes combat.

21-25 Worrywart, nervous and cautious.

26-37 Hot-head, quick-tempered, emotional, but basically nice.

38-45 Schemer, gambler who likes to take chances.

46-50 Blabber mouth, nice guy, but too talkative.

51-56 Wild man, cocky, overconfident, takes unnecessary risks.

57-66 Nice guy, friendly, courteous and hospitable.

67-76 Snob, arrogant, feels superior to others.

77-84 Tough guy, self-reliant, cocky, a lone wolf.

85-89 Paternal, overbearing, overprotective of others, especially young characters.

90-94 Complainer, constantly aggravated about something.

95-00 Paranoid, trusts no one.

THE ARMIES OF THE SOUTHERN CROSS

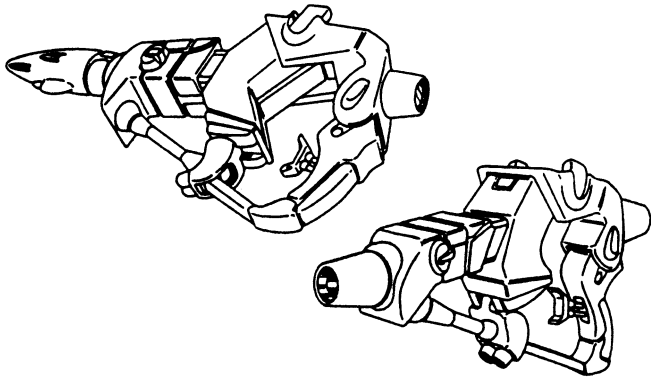

The Southern Cross World Headquarters is located at Monument City near what was once the Canadian (Calgary)/Montana border. This site was selected for three reasons: **One:** The global army could secure and cordon off the historic site of the SDF-1 and SDF-2. It was here that Khyron, the insane Zentraedi, made his suicide run into the famous battle fortress. Despite attempts to “clean” the site, dangerous levels of radiation permeate the area. To avoid endangering the lives of the curious and reverent, the giant warships have been buried and placed off limits. The presence of the Southern Cross insures this. **Two:** Legends of the SDF-1 and the secrets that might remain hidden inside her attract high-tech pirates. For their own protection, as well as world security, they must not be allowed to plunder the vessels. **Three:** The SDF-1 is a symbol of man’s tenacity and triumph over a seemingly unbeatable foe. The Southern Cross’ close proximity to the famous vessel stirs the hearts of all people, and at the same time imparts a certain credibility to Earth’s new defenders.

Monument City is a massive military complex, complete with robotechnology, manufacturing, space capabilities, arsenal, medical, housing, civilian and training facilities. It is the home of the *Tactical Corps*, *Tactical Air Force*, the *Cosmic Unit*, and mecha divisions the *Alpha Tactical Armored Corp (ATAC)* and the *Tactical Armored Space Corp (TASC)*. The Global Military Police (GMP) also have a major unit established at Monument City. All of these specific branches of the Southern Cross are headquartered in the North American Sector.

The *Civil Defense Unit* (ground troops), *Civil Defense Flying Corp*, and *Recon Escort Patrol*, are headquartered at the old *RDF Yellowstone Base*, about 150 miles to the south. The Yellowstone Base is considered to be part of the Monument City/Southern Cross military complex, which should give you a fair idea of the Armies’ scope. A small branch of the Robotech Defense Force (RDF) also still operates out of the Yellowstone Base in cooperation with the *Southern Cross*. A small arsenal of RDF mecha, in perfect condition, is maintained by the RDF. This tiny arsenal is comparatively the greatest collection in the world. They include: 20 Excaliber, 48 Gladiators, 27 Raidar X, 12 Spartans, 4 M.A.C. IIs and a squadron of 7 Veritech Fighters.

The remaining six Armies are found throughout the world, in trouble spots, strategic locations, and specific environments. They include the *Cold Weather Offensive Squad* in Scandinavia and polar regions, *Humid Climate Offensive Squad* in the Eastern Sector, the *Jungle Squad* in the Congo, South American and Eastern Sector, the *Desert Squad* patrolling the world’s wastelands, *Sea Squad* and *Mountain Offensive Squad*.

Within each of the *Fifteen Armies* of the Southern Cross are squadrons and battalions assigned to various parts of the world. They might operate alone, as separate military units, or combined with the different armies in a much larger offensive. During the Second Robotech War, the Armies of the Southern Cross and most of the global powers will unite to combat a common enemy, the *Robotech Masters*.

THE FIFTEEN ARMIES OF THE SOUTHERN CROSS

1. G.M.P./Global Military Police (investigative/covert operations)
2. T.C./Tactical Corp (main ground troops)
3. T.A.F./Tactical Air Force (main air troops)
4. T.A.S.C./Tactical Armored Space Corp (AJACS & Logan)
5. ATAC/Alpha Tactical Armored Corp (Hover Tanks)
6. R.E.P./Recon Escort Patrol (ground and air)
7. C.U./Cosmic Unit (also uses the AJACS)
8. C.D.U./Civil Defense Unit (ground)
9. C.D.F.C./Civil Defense Flying Corp(air)
10. C.W.O.S./Cold Weather Offensive Squad
11. H.C.O.S./Humid Climate Offensive Squad
12. M.O.S./Mountain Offensive Squad
13. D.S./Desert Squad
14. J.S./Jungle Squad
15. S.S./Sea Squad

THE GLOBAL MILITARY POLICE (G.M.P.)

The G.M.P. is a powerful **intelligence** agency that operates within, and outside of, the Southern Cross. It is the only, truly worldwide, law enforcement agency keeping tight reigns on all global powers, including the Armies of the Southern Cross. As a sort of big brother, the G.M.P. casts a watchful eye on those who have access to robotechnology and high technology. To effectively do this the GMP has its own war machinery, combat forces and intelligence network. The elite soldiers of the G.M.P. are answerable only to officers within that branch of the service, the supreme commander of the Southern Cross and the scrutiny of the United Earth Government.

The Global Military Police possess top security clearance and have access to all conventional arms, armor, equipment and vehicles, including the hover cycle and other hover craft. **Special items exclusive** to the GMP include their giant *Security Robots* and the *GMP Multi-purpose Battloid*. Although the Military Police are not trained in the piloting of transformable mecha, they can requisition pilots and mecha from the ATAC and TASC if needed for a special operation.

The Global Military Police often act on their own volition without the approval or knowledge of their superiors. The attitudes of these elite soldiers are that of superiority, cunning and secretiveness. For this reason the soldiers of the other Armies tend to view the GMP with suspicion and contempt. If all the other Armies are brothers of the same military fraternity, the GMP is the sly, lone wolf.

THE G.M.P. O.C.C.

The Global Military Police are basically military specialists, highly trained in combat and espionage. Most of the G.M.P.’s training revolves around intelligence, tracking fugitives, infiltrating enemy strongholds, and clandestine operations.

The G.M.P.’s training does NOT include mecha. However, the character can learn to pilot a *battloid*. In this regard, it is one of the few O.C.C.s that allows *E.B.S.I.S. Battloid* piloting/hand to hand skills to be learned. Most of the skills reflect covert activity. **Note:** That while the GMP has a reputation for being ruthless, even with its own people, many of these men and women are as loyal, dedicated and trustworthy as any other O.C.C.

In addition to the O.C.C. skills listed with bonuses, the player can select “other” skill areas. These additional skills are limited only as stated.

MALE OFFICER

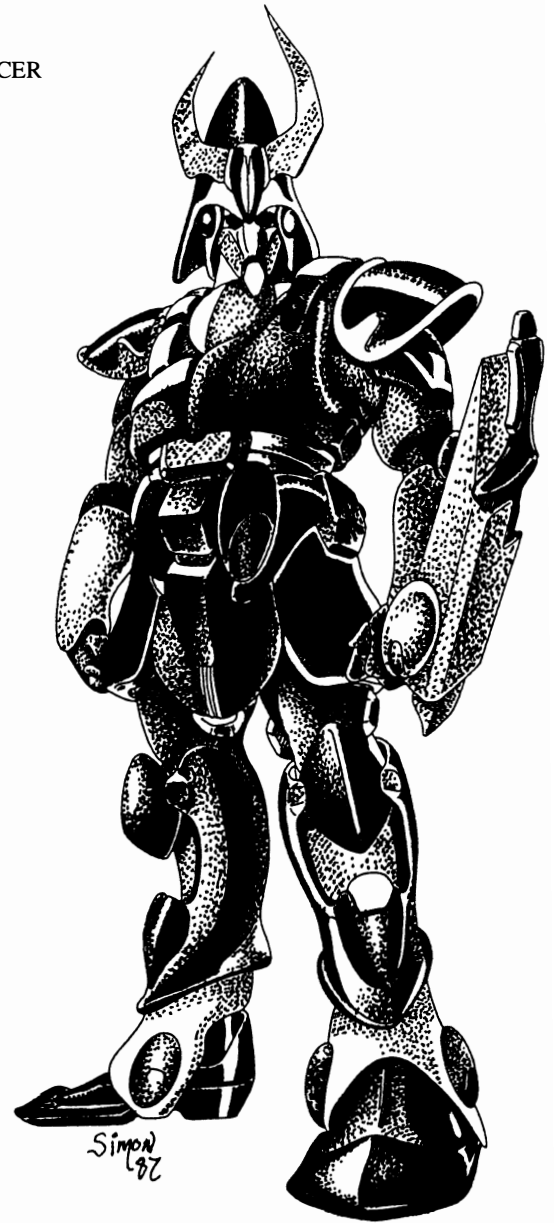

FEMALE OFFICER

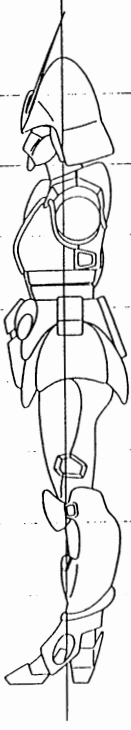
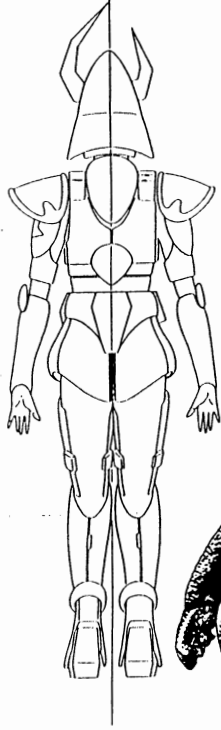

GMP FEMALE BODY ARMOR

LOW RANKING OFFICER



SOLDIER



GMP INSIGNIA

Attribute Requirements: I.Q. 10, P.P. 10

O.C.C. Skills:

Surveillance (+10%)

Intelligence (+20%)

Interrogation (+10%)

Land Navigation

Pilot Automobile

Hand to Hand Expert or Martial Arts (choose one)

W.P. Energy Pistol

W.P. Automatic Pistol

M.O.S. Skills:

Any one M.O.S. can be selected, but the most common G.M.P. MOSs are Military Intelligence, Combat, Weapons and Pilot.

Other Skills: Select 10 Other Skills.

Communications: Any (+5%)

Domestic: Any

Electric: Basic Electronics Only

Espionage: Any (+10%)

Mechanical: Auto or Aircraft Mechanics Only

Medical: First Aid Only (+5%)

Physical: Any (+10% on skill percentages, like prowl)

Pilot: Any

Pilot Related: Any

Science: Mathematics Basic and Advanced Only

Technology: Any, including Demolitions (+15% on Demo)

W.P.: Any

Authorized Clearance Upon Assignment: Multi-purpose Battloid, jet pack, security robot, land vehicles, tanks, aircraft, explosives, heavy equipment, RF-100 rapid fire pulse laser, surveillance equipment, personal and special equipment, such as lock picking tools, cameras, optics, etc. Use of additional assigned personnel/assistant(s) and mecha, as well as access to medical, research and laboratory facilities.

Standard Equipment: G.M.P. custom-fitted body armor, combat shield, standard back pack, standard utility belt, 9mm automatic pistol, L.P. Nightstalker laser pistol, wrist radio (short range — 8 miles), uniform, a personal conventional vehicle (car or motorcycle), as well as access to any and all conventional equipment, tools, weapons and vehicles.

Monthly Wages: 2200 credits per month for enlisted men at levels 1-5; 6th level and higher is 2800 credits per month. Officers make as much as 3200 to 4600 credits per month. Experts and expert free agents can make outrageous amounts of money, (6000 to 36,000 per job) depending on the dangers, area of expertise and circumstances. Freelance agents are generally of anarchist, unprincipled or evil alignments. Such mercenaries are usually looked upon with disdain.

Personal Savings: 4D6 × 100 credits.

THE TACTICAL CORP (T.C.)

The main, frontline army of the Southern Cross is the Tactical Corp. Like the United States Marines of old, the soldiers of the T.C. are trained in the art of hand to hand combat in all environments. Consequently, they function equally well in forest, jungle, desert or urban environments, as well as limited training for space and sea combat. They are tough, down to earth warriors dedicated to the protection of the planet Earth and all her people. Wherever they are. The T.C. are the true grunts of the Southern Cross' fifteen armies.

THE TACTICAL CORP O.C.C.

The Tactical Corp is composed of warriors! These capable men and women are highly trained in the skills of war and little else. The T.C. are almost always involved in seek and destroy missions, rescue, reconnaissance, assaults and other, dangerous, combat expeditions.

T.C. training can include mecha, but is strictly limited to Pilot Battloid and Battloid Mecha combat. No other mecha piloting skills are available. The Tactical Corp utilizes battloids to such an extent that they have their own design, *the T.C. Recon Battloid*. The T.C. Battloid is specifically designed to accommodate the versatility of combat needs of the corp. Consequently, it is fast, mobile and deadly. *See Battloid Mecha for details.*

In addition to the O.C.C. skills listed with bonuses, the player must select an area of Military Specialty (M.O.S.) and "other" skills. These additional skills are limited only as stated.

Attribute Requirements: I.Q. 8, P.S. 10; high P.P. is preferred, but not a prerequisite.

O.C.C. Skills:

Read Sensory Instruments (+10%)

Weapon Systems (+10%)

Pilot Tank (+15%)

Prowl (+20%)

Hand to Hand: Martial Arts

W.P. Energy Pistol

W.P. Energy Rifle

M.O.S. Skills:

Any one M.O.S. category of skills can be selected, but the most likely are Combat, Weapons, Military Intelligence, Pilot and Communications.

Other Skills: Select 11 Other Skills

Communication: Any

Domestic: Any

Electrical: Basic Electronics Only

Espionage: Any (+15%)

Mechanical: Auto or Aircraft Mechanics Only

Medical: First Aid Only

Physical: Any (+5% on skill percentages, like climbing)

Pilot: Any

Pilot Related: Any

Science: Mathematics Basic and Advanced Only

Technical: Any (+10%)

W.P.: Any

Authorized Clearance Upon Assignment: T.C. Recon Battloid, special back packs, land vehicles, tanks, explosives, heavy weapons, surveillance equipment, and additional personnel, mecha and non-standard equipment.

Standard Equipment: T.C. custom-fitted body armor, heavy combat shield, standard back pack, heavy utility belt, tri-laser or PPL-12 pulse laser pistol, LR-20 laser rifle, wrist radio (short range — 8 miles), uniform, binoculars, first-aid kit, signal flares, flashlight, survival knife and canteen.

Monthly Wages: 1800 credits per month for enlisted men at levels 1-5; 6th level and higher is 2400 credits per month. Officers make as much as 2800 to 4000 credits per month.

Personal Savings: 4D6 × 100 credits.

TACTICAL CORP

MALE OFFICER



LOW RANKING OFFICER



HEAVY COMBAT SHIELD

SOLDIER

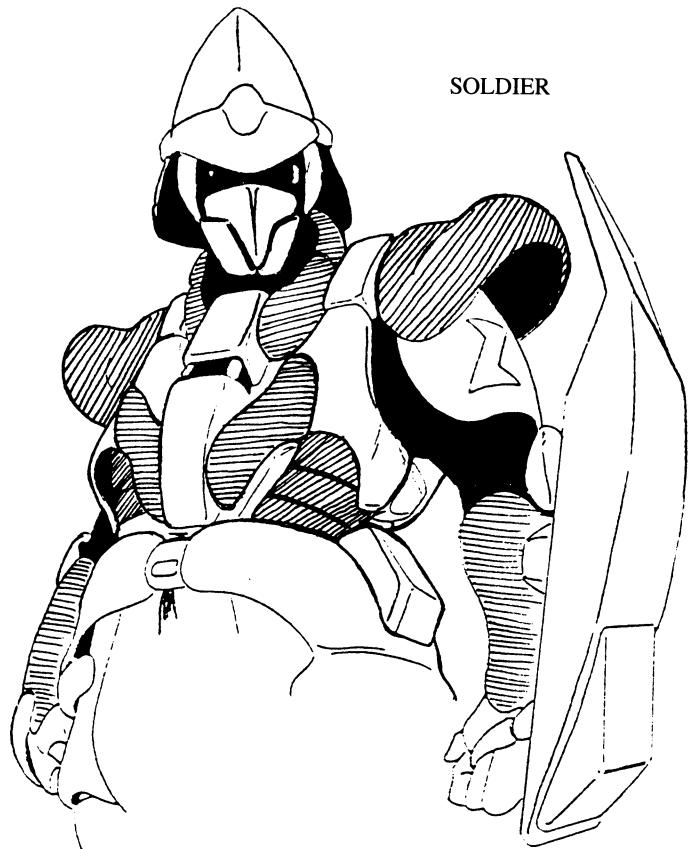

T.C. INSIGNIA

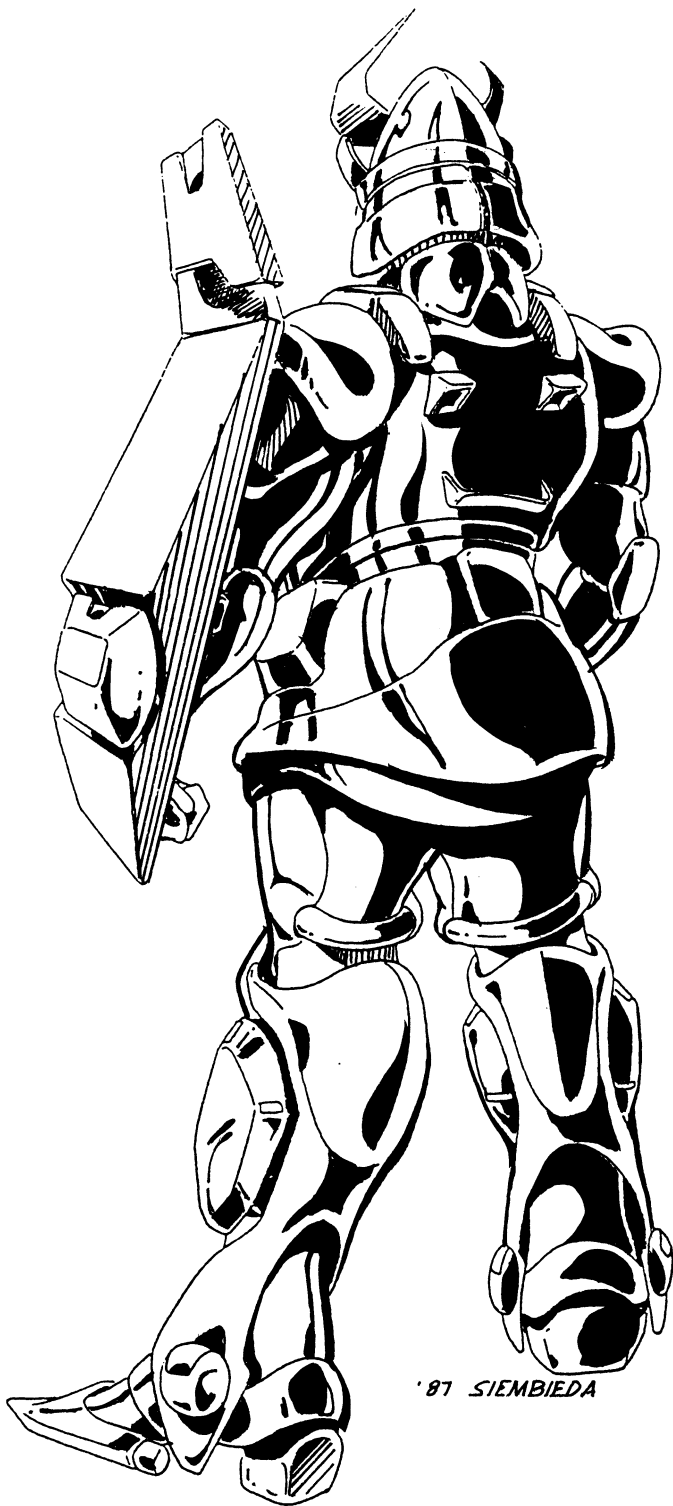

T.C. OFFICER BACK VIEW
SHOWING BACK-PACK MOUNTS.

TACTICAL AIR FORCE (T.A.F.)

Like their ground counterparts, the Tactical Air Force represents the main *aerial* combat force of the Southern Cross. The soldiers of the T.A.F. are trained combat pilots in all conventional fighter aircraft, and the *Phantom* and *Specter* jet fighters specifically.

THE TACTICAL AIR FORCE O.C.C.

The T.A.F. are masters of aerial combat who seem to bring their fighters to life like giant birds of prey. No pilots in the world can match the T.A.F. in aerial combat. On the ground they are capable soldiers, trained in hand to hand combat, and skilled in the use of the *jet pack* which can transform the ground-locked pilot himself into a soaring bird of prey. The sight of a squad of T.A.F. pilots darting through the skies, powered only by their small jet pack, can be as impressive as their high speed, precision maneuvers in jet fighters.

Although a T.A.F. pilot can be trained to operate a battloid, it is not part of their formal training, and must be selected as an "other" skill or as part of a MOS package. They are NOT able to pilot the Logan or AJACS veritech fighters.

In addition to the O.C.C. skills listed with bonuses, the player must select an area of military specialty (MOS) and "other" skills. These additional skills are limited only as stated.

Special O.C.C. Bonus: the T.A.F. pilots are so skilled that they are +1 to *dodge* when piloting *any* aircraft or using the jet pack.

Attribute Requirements: I.Q. 8, P.P. 9 or higher is preferred, but not imperative.

O.C.C. Skills:

Pilot Jet (+20%)

Pilot Helicopter (+10%)

Pilot Jet Pack (+20%)

Navigation (+15%)

Read Sensory Instruments (+15%)

Weapon Systems (+20%)

*Hand to Hand: Expert

W.P. Energy Pistol

*Hand to Hand can be changed to Martial Arts, but costs one skill.

M.O.S. Skills:

Any one M.O.S. category of skills, except Military Intelligence, can be selected, but the most likely are Pilot, Communications and Mechanical.

Other Skills: Select 10 Other Skills

Communications: Any (+5%)

Domestic: Any

Electrical: Basic Electronics Only

Espionage: Any (even though the Intelligence MOS is not available).

Mechanical: Auto or Aircraft Mechanics Only

Medical: First Aid Only

Physical: Any

Pilot: Any (+5%)

Pilot Related: Any (+10%)

Science: Basic and Advanced Mathematics Only

Technical: Any (+5%)

W.P.: Any

Authorized Clearance Upon Assignment: Aircraft, land vehicles, battloid, explosives, heavy weapons, surveillance equipment, and access to special personnel and non-standard equipment.

Standard Equipment: T.A.F. custom-fitted body armor, light combat shield, standard back pack, jet pack, standard utility belt, P-20 pulse laser, wrist radio (short range — 8 miles), uniform, parachute, 3 signal flares, flashlight, and survival knife.

Monthly Wages: 2000 credits per month for enlisted men at levels 1-5; 6th level and higher is 2600 credits per month. Officers make 3000 to 4000 credits per month.

Personal Savings: 4D6 × 100 credits.

TACTICAL AIR FORCE

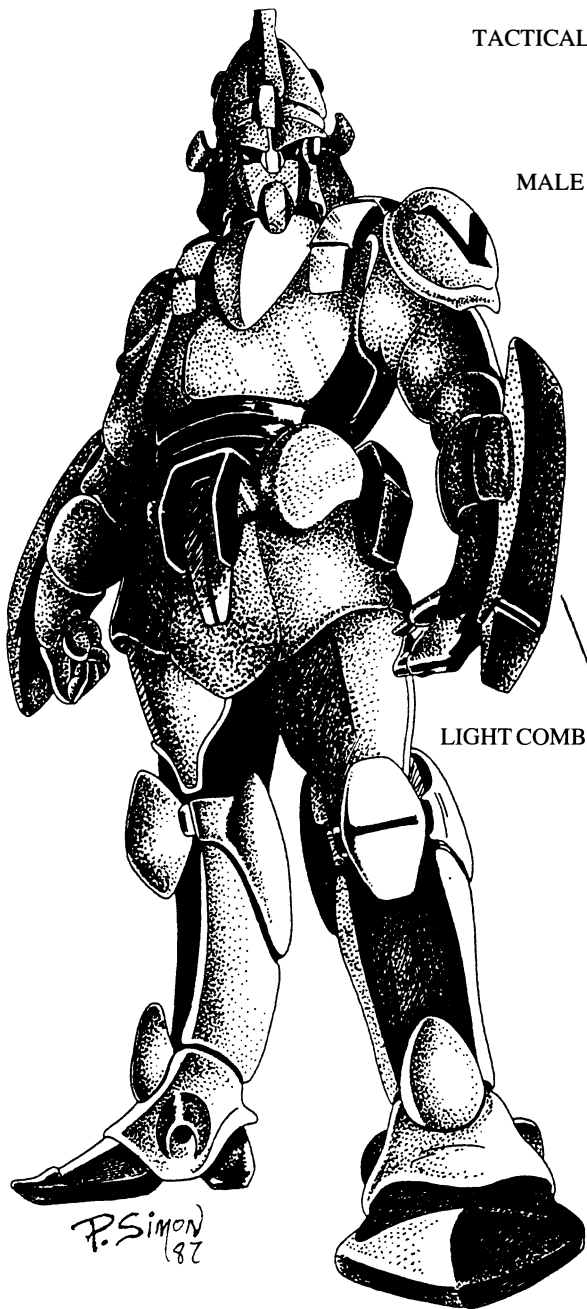

MALE OFFICER

LIGHT COMBAT SHIELD

P. Simon
87

LOW RANKING OFFICER



SOLDIER

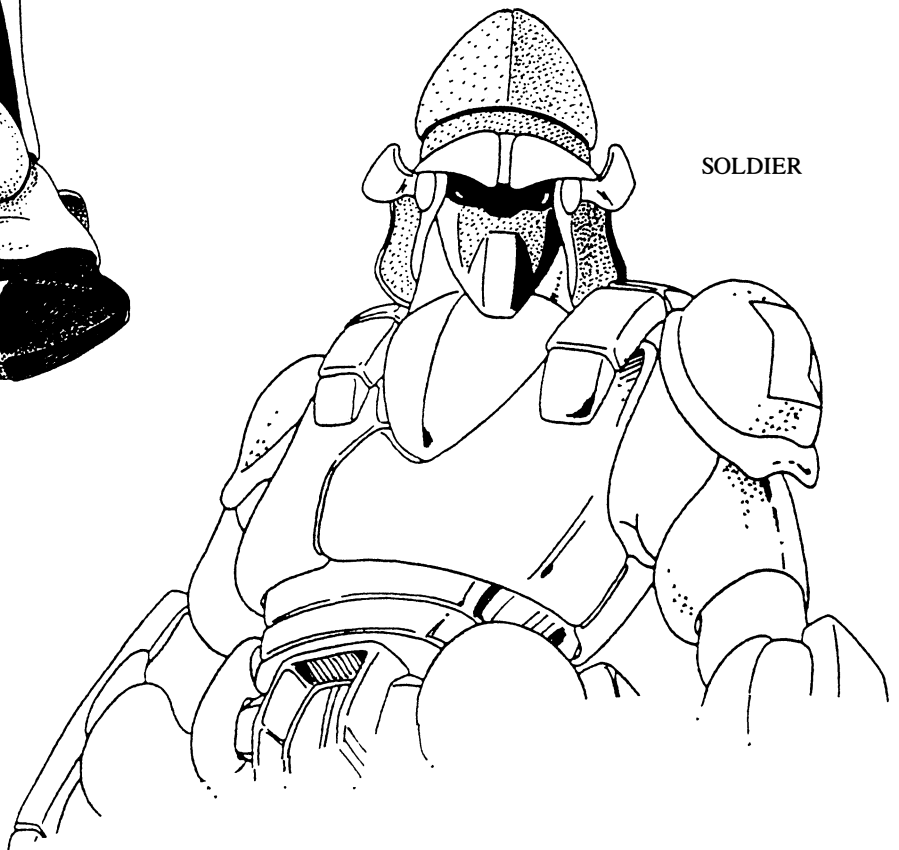

T.A.F. INSIGNIA

THE TACTICAL ARMORED SPACE CORP (T.A.S.C.)

The T.A.S.C. is an elite army trained to pilot transformable, Veritech, air and space mecha. Their main mecha of choice is the versatile trans-atmospheric space mecha, AJACS Attack Copter. Many believe the AJACS is more formidable in space than the old VF series Veritech Fighters.

Experts in Veritech air vehicles, the T.A.S.C. pilots also pilot the transformable Logan. A light Veritech fighter best suited for aerial combat.

The Veritech pilot is taught every aspect of his machine under the most difficult combat conditions on land, air and space. Although the T.A.S.C. pilot *can* learn to pilot Battloids, it is not part of the formal training and must be selected as one of the character's "other" skills, or as one of the skills selected for a pilot MOS. Each additional mecha combat skill counts as one skill.

The T.A.S.C. body armor is unique in that it is designed for mobility in space. To accomplish this, it has several maneuvering jets built into the feet, knees and chest, and shield. Speed and mobility can be further enhanced with the addition of the *Space Booster Back Pack*. The self contained oxygen supply of the body armor enables these bold warriors to function in space without the protection of their mecha or spacecraft.

In addition to the O.C.C. skills listed with bonuses, the player must select an area of military specialty (MOS) and "other" skills. These skills are limited only as listed.

Attribute Requirements: I.Q. 8; P.P. 9 or higher is preferred, but not a necessity.

O.C.C. Skills:

Pilot AJACS Veritech 'Copter: 70% + 3% per level of experience.

Pilot Logan Veritech: 62% + 3% per level of experience.

Mecha Combat: AJACS

Mecha Combat: Logan

Weapon Systems (+20%)

Read Sensory Instruments (+15%)

Navigation (+15%)

*Hand to Hand: Basic

*Hand to Hand Basic can be changed to Expert at the cost of one skill, or changed to Martial Arts at the cost of two skills.

M.O.S. Skills

Any one MOS category of skills can be selected. The most likely are Pilot, Mechanical or Combat.

Other Skills: Select 8 Other Skills

Communication: Any

Domestic: Any

Electrical: Basic Electronics Only

Espionage: None

Mechanical: Auto or Aircraft Mechanics Only

Medical: First Aid Only

Physical: Any

Pilot: Any (+10% on all aircraft)

Pilot Related (+10%)

Science: Basic and Advanced Mathematics Only

Technical: Any

W.P.: Any

Authorized Clearance Upon Assignment: Aircraft, land vehicles, battloid, explosives, heavy weapons, jet pack, and access to special personnel and equipment.

Standard Equipment: One regularly assigned AJACS and Logan, T.A.S.C. custom-fitted body armor, space shield, space booster back pack, space utility belt, P-20 pulse laser, wrist radio (short range — 8 miles), uniform, 3 signal flares, flashlight and 150 feet (42.3m) of nylon cord.

Monthly Wages: 2300 credits per month for enlisted men at levels 1-5; 6th level and higher is 3000 credits per month, while officers make 3400 to 4400 per month.

Personal Savings: 5D6 × 100 credits.

TACTICAL ARMORED SPACE CORP O.C.C.

The T.A.S.C. fighter pilot is the *only* character trained to pilot the transformable, Veritech AJACS Attack 'Copter and Logan fighter. As an expert veritech pilot this character could also pilot the old VF series Veritech Fighters, but *without* the Veritech Mecha Combat Skill. Note: the VF series Veritech is not a part of the Southern Cross' complement of mecha.

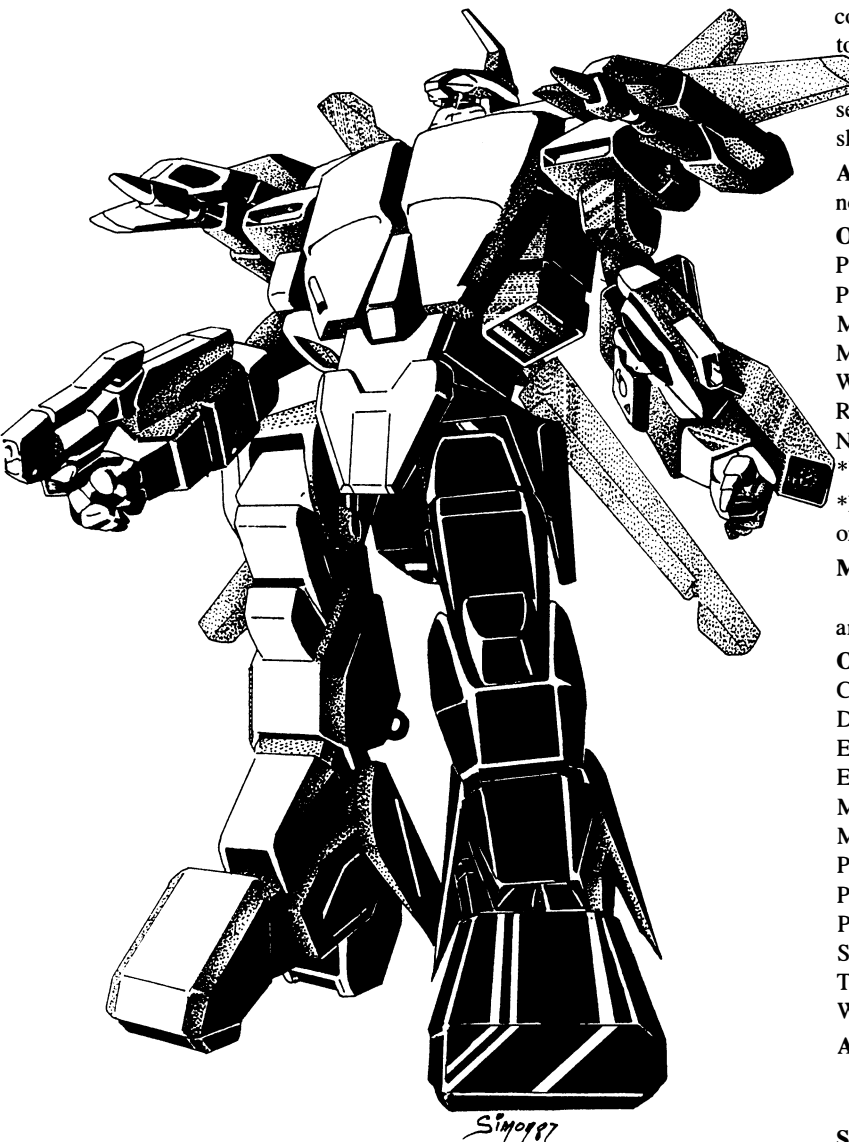

TACTICAL ARMORED SPACE CORP

T.A.S.C. INSIGNIA

MALE OFFICER

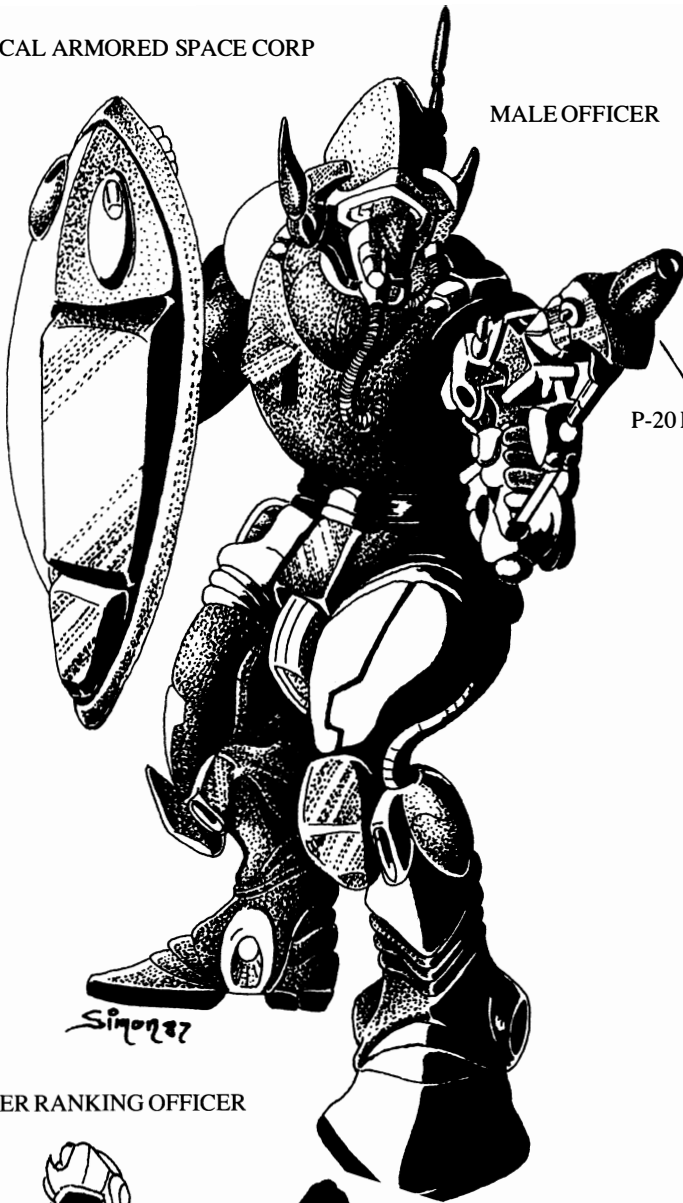

P-20 PULSE LASER



FEMALE OFFICER

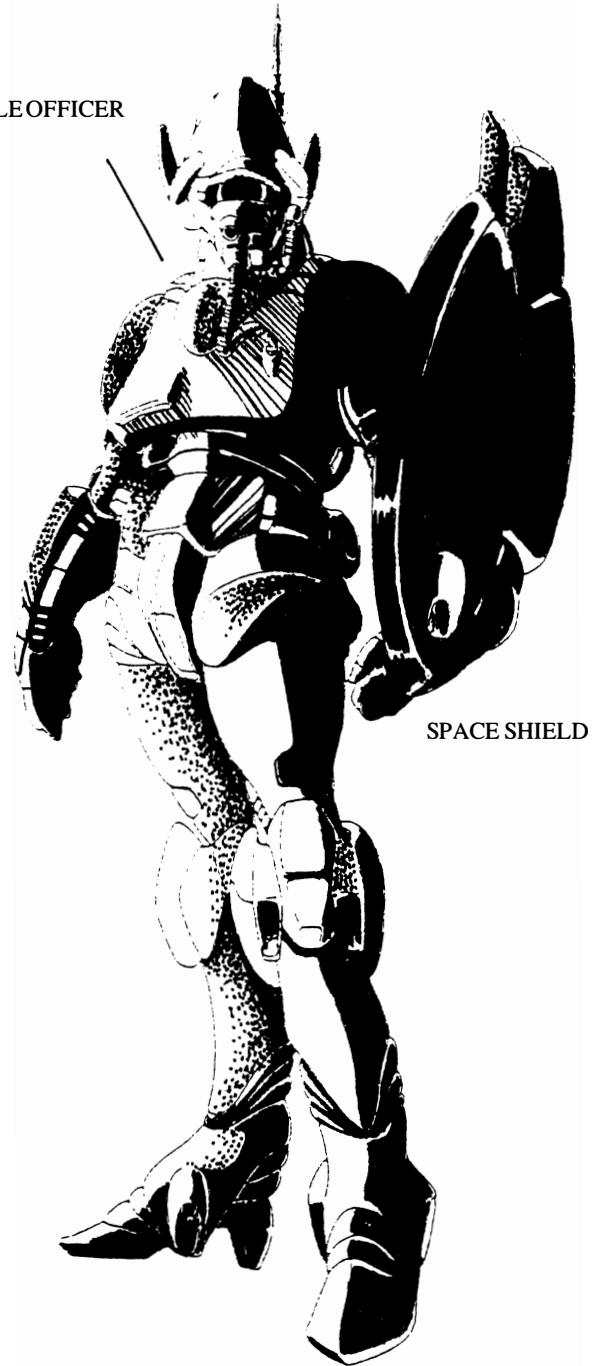

SPACE SHIELD

LOWER RANKING OFFICER

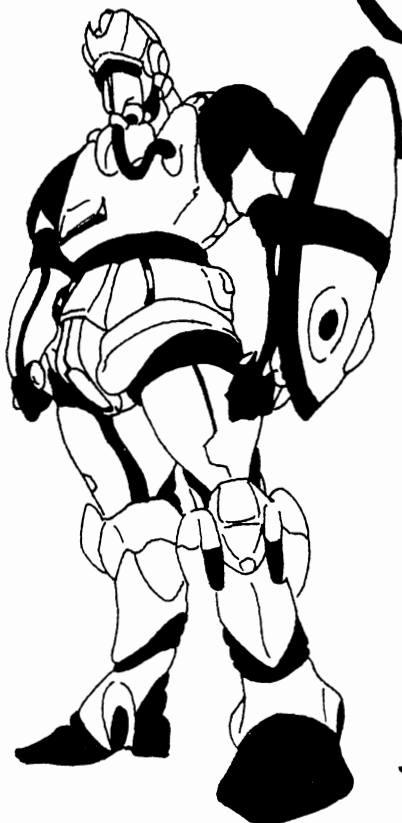

SOLDIER

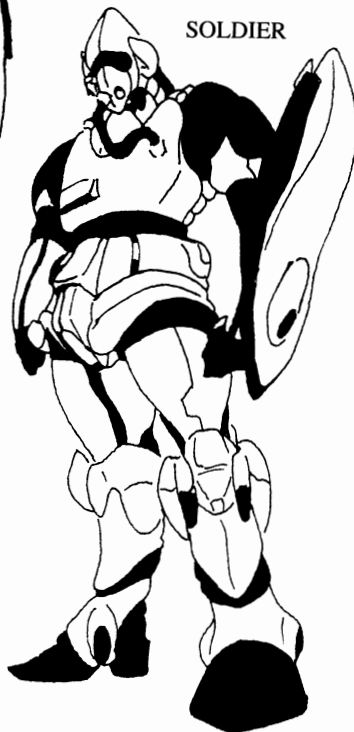

ALPHA TACTICAL ARMORED CORP (A.T.A.C.)

The super-elite grunts of the ground forces are the A.T.A.C. pilots who operate the Veritech Hover Tanks (V.H.T.). The Veritech Hover Tank may outclass the RDF's Destroids as the most devastating ground mecha created by man. Its three modes of operation/transformation certainly gives the mecha greater speed and versatility of movement than any Destroid. In raw strength, the battloid mode compares closely with the Gladiator. In firepower the VHT rivals the Excaliber. It is a truly remarkable, all terrain, assault mecha.

ALPHA TACTICAL ARMORED CORP O.C.C.

The A.T.A.C. soldier undergoes a grueling training program, both with and without the mecha. At the end of the program, man and machine function as one. The transformation sequences are smooth, instant transitions that take advantage of the mecha's versatility to optimize every situation. Additional mecha training in the use of non-transformable Battloids is available if desired. (*Player Note:* Each additional mecha skill must be counted as one of your "other" skill selections).

The ATAC represents the Armies of the Southern Cross' heavy, mobile combat units. As such, they are deployed in frontline offensives, used as heavy support units, and *often assigned to operate with other armies*, divisions and special teams. Assignments vary greatly from spearheading an assault to escorting an important dignitary. Typically, the ATAC are sent on the most dangerous missions. These can be reconnaissance deep within enemy territory, assault, seek and destroy, rescue, defense, and may even take them into space. The Veritech Hover Tank *is* space-worthy, but lacks a proper propulsion system and suffers from very limited mobility unless on the ground or in/on a spacecraft. Likewise the VHT is an adequate underwater vehicle, but suffers from the same lack of mobility. *Maximum depth underwater is one mile (1.6km).*

In addition to the O.C.C. skills listed with bonuses, the player must select an area of Military Specialty (MOS) and "other" skills. These skills are limited only as listed.

Attribute Requirements: I.Q. 7; a high P.P. is preferred, but is not a prerequisite.

O.C.C. Skills:

Pilot Hover Cycle (+20%)

Pilot Veritech Hover Tank: 70% + 3% per level of experience.

Mecha Combat: Veritech Hover Tank

Weapon Systems (+20%)

Read Sensory Instruments (+15%)

Navigation (+10%)

*Hand to Hand: Expert

W.P. Energy Pistol

W.P. Energy Rifle

*Hand to Hand Expert can be changed to Martial Arts, but at the cost of one skill.

M.O.S. Skills:

Any one M.O.S. category of skills, except Military Intelligence, can be selected. The most common among the A.T.A.C. are Combat, Weapons, Pilot, Mechanical and Communications.

Other Skills: Select 8 Other Skills

Communication: Any

Domestic: Any

Electrical: Basic Electronics Only

Espionage: None

Mechanical: Auto Mechanics Only

Medical: First Aid Only

Physical: Any

Pilot: Any (+10% on all land vehicles)

Pilot Related: Any (+8%)

Science: Basic and Advanced Mathematics Only

Technical: Any

W.P.: Any

Authorized Clearance Upon Assignment: Land vehicles, battloid, explosives, heavy weapons, surveillance equipment, and access to special personnel and equipment.

Standard Equipment: One regularly assigned Veritech Hover Tank and Hover Cycle, A.T.A.C. custom-fitted body armor, heavy combat shield, standard back pack, heavy utility belt, PPL-12 Panther pulse laser (pistol), LR-20 laser rifle, wrist radio (short range — 8 miles), knife. *The V.H.T.* usually comes equipped with 200ft (61m) of nylon cord, one grappling hook, infrared distancing binoculars, 4 weeks of food rations, 2 gallons of water, and a 9mm automatic pistol.

Monthly Wages: 2400 credits per month for enlisted men at level 1-5; 6th level and higher is 3000 credits per month, while officers receive 3400 to 4400 credits per month.

Personal Savings: 5D6 × 100 credits.

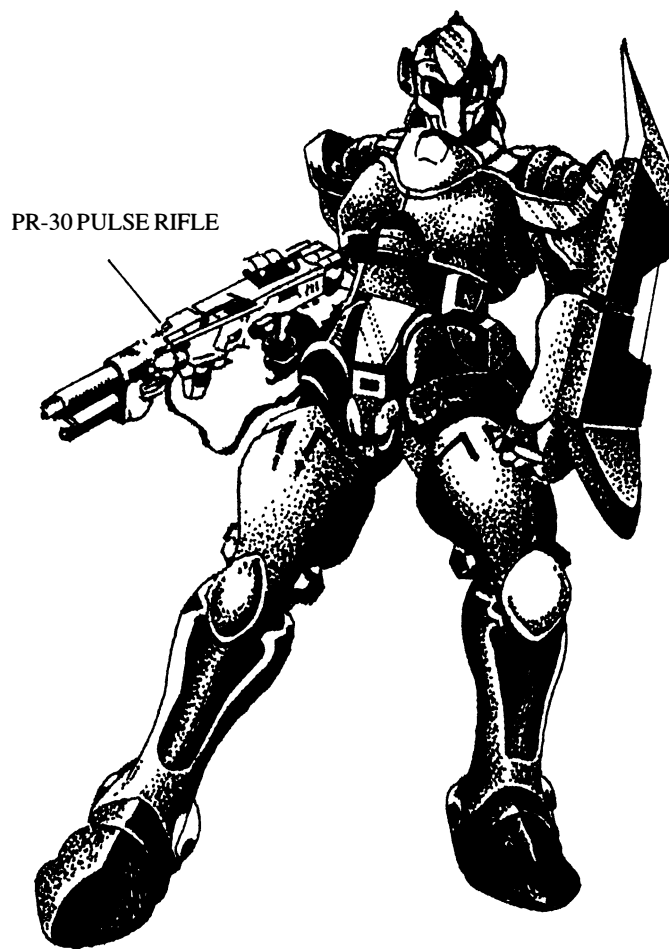

PR-30 PULSE RIFLE

A.T.A.C. LOW RANKING OFFICER

ALPHA TACTICAL ARMORED CORP

MALE OFFICER

LR-30 LASER RIFLE

FEMALE BODY ARMOR

HEAVY COMBAT SHIELD

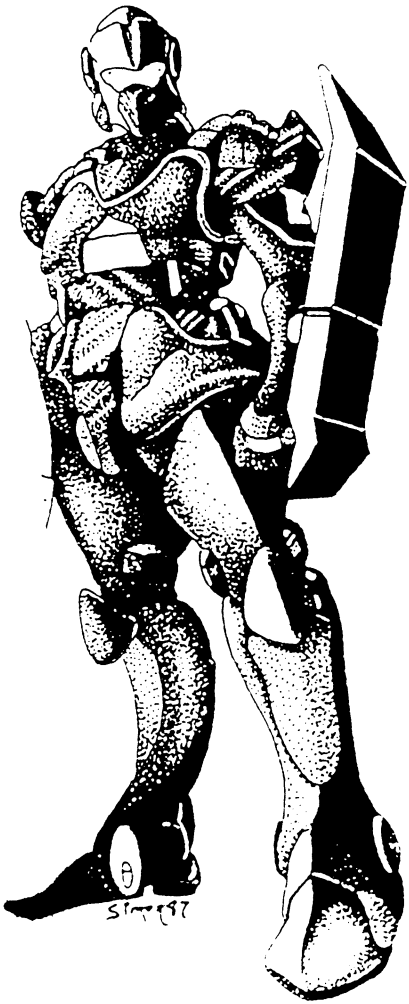

MALE SOLDIER



FEMALE OFFICER

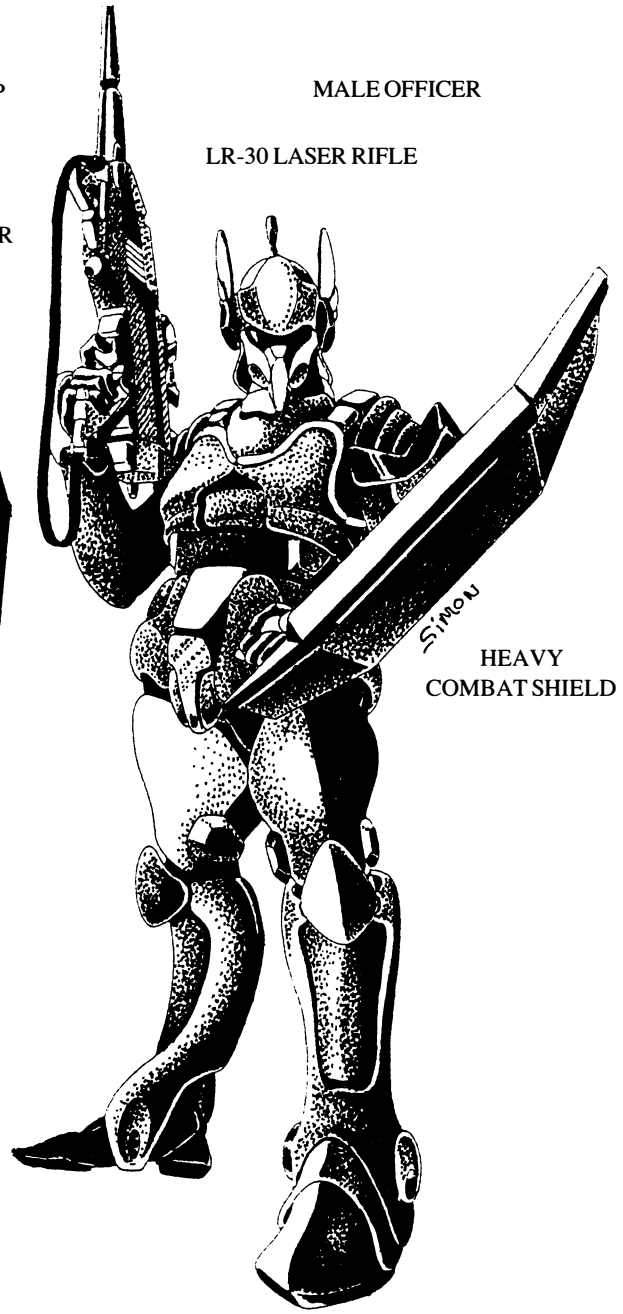

VHT IN TANK MODE

A.T.A.C. INSIGNIA

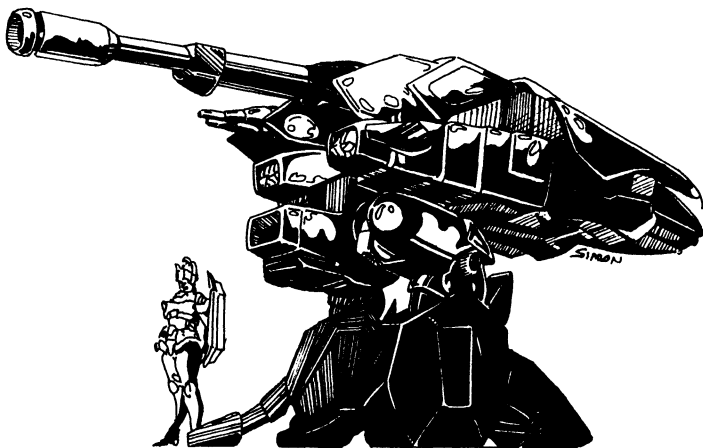

A.T.A.C. OFFICER INDICATES SCALE



THE RECON ESCORT PATROL (R.E.P.)

The Recon Escort Patrol is a highly specialized army responsible for penetrating the enemy line to gather intelligence and provide support for tactical and covert operations. Consequently, the R.E.P. often works with the T.C. and G.M.P., as well as special teams. They are trained to operate in all environments including space, but most operations are ground-based.

The R.E.P.'s area of expertise is simple, "locate, identify and neutralize the enemy". The escort aspect of operations means that a R.E.P. team will accompany an individual, squadron or convoy; scouting ahead to make certain that any enemies in the area are located, identified and neutralized before they can harm the target of the escort.

THE RECON ESCORT PATROL O.C.C

The R.E.P. character is a tough, cunning, fighting machine that can live off the land and engage the enemy. As previously stated, these soldiers are assigned to protect and escort individuals or operations which are likely to be targets of enemy assault. The R.E.P. also engage in long-range reconnaissance patrols and hunter-killer missions to provide intelligence for other army units. Although a R.E.P. soldier(s) may be assigned to a special team that uses mecha, and readily acknowledges the usefulness of the giant machines, he, himself, will not pilot mecha. Recon operations require becoming part of the land. To move swiftly and silently through the underbrush. Something you can not do with mecha.

In addition to the O.C.C. skills listed with bonuses, the player must select an area of military specialty (MOS) and other skills. These skills are limited only as listed.

Attribute Requirements: P.S. 12; greater strength, P.P. and I.Q. (above 7) are preferred, but not a necessity.

O.C.C. Skills:

Detect Ambush (+20%)
 Detect Concealment (+15%)
 Intelligence (+10%)
 Land Navigation (+10%)
 Wilderness Survival (+10%)
 Tracking (+20%)
 Sniper
 W.P. Energy Pistol
 Hand to Hand: Martial Arts

M.O.S. Skills:

M.O.S. selection is *limited* to Combat, Weapons, Pilot and Communication. The Military Intelligence MOS is NOT available, even though many of the O.C.C. skills are from the Espionage category.

Other Skills: Select 8 Other Skills

Communication: Any
 Domestic: Any
 Electrical: Basic Electronics Only
 Espionage: None
 Mechanical: Auto Mechanics and Locksmith Only
 Medical: First Aid or Paramedic* Only
 Physical: Any (+5% skill percentages, like prowl)
 Pilot: Any, except Mecha
 Pilot Related: Any (+5%)
 Science: Basic and Advanced Mathematics Only
 Technical: Any (+10% on Demolition skill)
 W.P.: Any

*The Paramedic skill counts as two skills.

Authorized Clearance Upon Assignment: Any vehicles, explosives, heavy weapons, surveillance equipment, jet pack, air tanks, optics,

and any special equipment needed.

Standard Equipment: One regularly assigned Hover Cycle or conventional ground vehicle, REP custom fitted body armor, light combat shield, standard survival kit, heavy utility belt, L.P. Nightstalker laser pistol, wrist radio (short range — 8 miles), uniform, 6 signal flares, flashlight, 2 survival knives, and infrared distancing binoculars.

Standard Additional Equipment for the Field: Choice of two additional weapons (usually a LR-20 laser rifle is one of them and often a conventional projectile weapon is the other), 2 to 8 cobalt grenades, 2 to 4 smoke grenades, food rations for 4 weeks. A portable scan dilator (ROBOTECH® RPG, pg 81) and vehicle(s) are assigned and assigned to the group.

Monthly Wages: 2000 credits per month for enlisted men at levels 1-5; 6th level and higher is 2400 credits per month, while officers receive 2800 to 4200 per month.

Personal Savings: 3D6 × 100 credits; R.E.P. soldiers tend to enjoy money while they can.

R.E.P. OFFICER

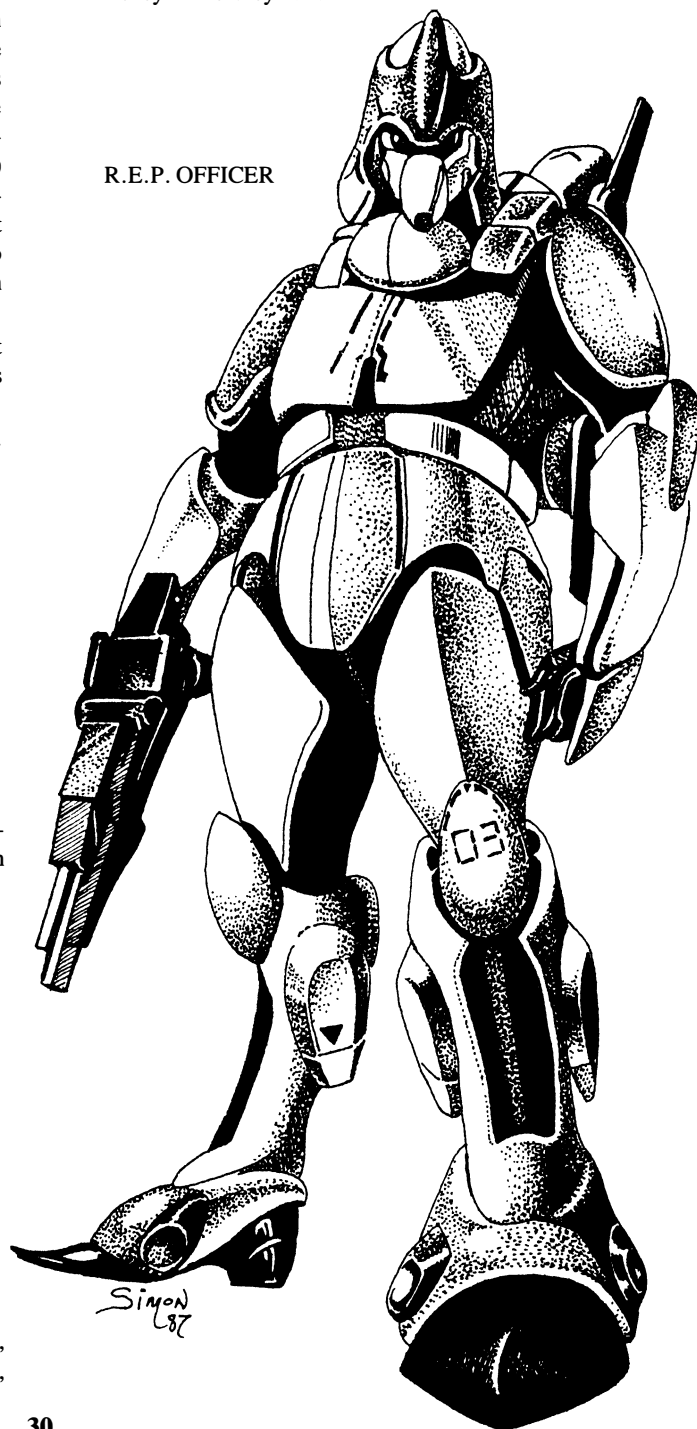

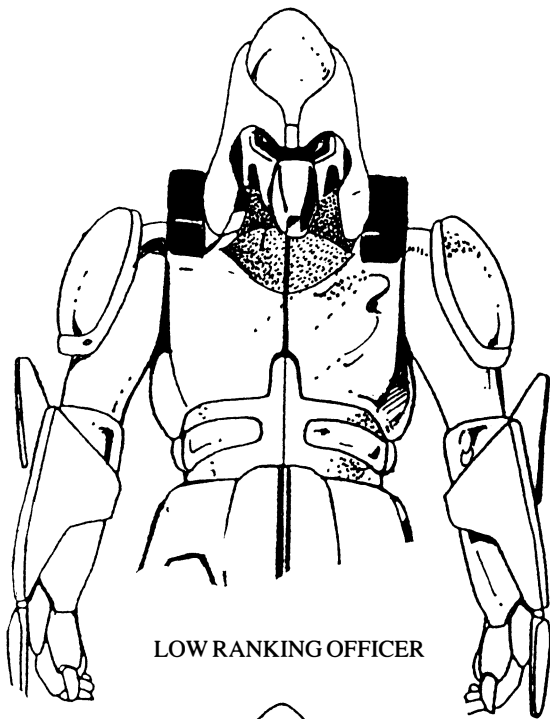

LOW RANKING OFFICER

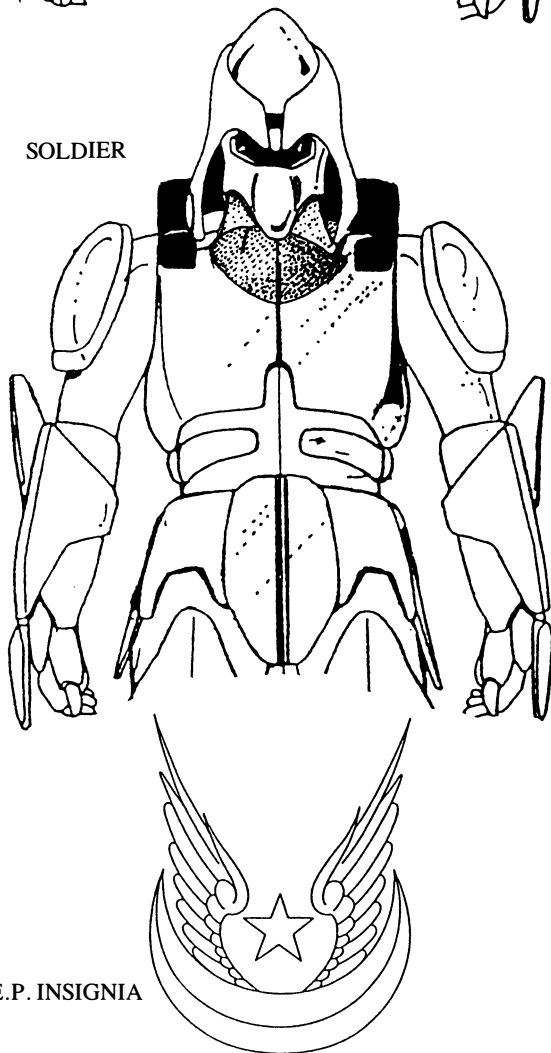

SOLDIER

R.E.P. INSIGNIA

THE COSMIC UNIT (C.U.)

If there can be such a thing as space commandos, then the Cosmic Unit are they. These dynamic soldiers are trained to operate in the unusual conditions unique to outerspace. It is the Cosmic Unit who guards and protects the various off-world colonies, outposts and space stations.

THE COSMIC UNIT O.C.C.

The C.U. soldier is an expert in space combat and a fair pilot. They protect off-world outposts, protect and escort space shuttles, conduct reconnaissance/exploration missions, track down fugitives, and perform missions of rescue and recovery.

To provide this Army with a bit of extra muscle the C.U. has a non-transformable Battloid designed for use in space. The battloid has a myriad of uses, from manual labor to assault and defense. The battloid has several maneuvering jets in the front and back that provide it with amazing speed and agility in space.

The C.U. body armor is also designed for use in outerspace. The soldier can leave the shelter of a spacecraft knowing that his environmental body armor will keep him safe. But the armor is more than just a protective suit; it is a self-propelling unit. Maneuvering jets in the feet, chest, back, and combat shield, can propel the warrior at speeds of up to 20mph (32kmph). The jets also allow for exceptionally fluid movement. The addition of the space booster jet pack just enhances the overall mobility.

In addition to the O.C.C. skills listed with bonuses, the player must select an area of military specialty (MOS) and other skills. These skills are limited only as listed.

Attribute Requirements: I.Q. 6; high P.P. is preferred, but is not a prerequisite.

O.C.C. Skills:

- Pilot Space Shuttle (+10%)
- Pilot Jet Pack (+10%)
- Navigation: Space (+10%)
- Read Sensory Instruments (+20%)
- Weapon Systems (+5%)
- Hand to Hand: Expert
- W.P. Energy Pistol
- W.P. Energy Rifle

M.O.S. Skills:

Any one M.O.S. category of skills, except Military Intelligence, can be selected.

Other Skills: Select 10 Other Skills

- Communications: Any (+5%)
- Domestic: Any
- Electrical: Basic Electronics Only
- Mechanical: Auto and Aircraft Mechanics Only
- Medical: First Aid Only
- Physical: Any
- Pilot: Any (+5%)
- Pilot Related: Any (+5%)
- Science: Basic and Advanced Mathematics Only
- Technical: Any
- W.P.: Any

Authorized Clearance Upon Assignment: Spacecraft, air and land vehicles, battloid, explosives, heavy weapons, surveillance equipment, and access to special personnel and equipment.

Standard Equipment: C.U. custom-fitted body armor, space shield, space booster pack, space utility belt, PPL-12 Panther pulse laser pistol, LR-30 laser assault rifle, one cobalt grenade, wrist radio (short range — 8 miles), uniform, flashlight.

Monthly Wages: 2100 credits per month for enlisted men at levels 1-5; 6th level and higher is 2800 per month, while officers receive 3200 to 4400 credits per month.

Personal Savings: 4D6 × 100 credits.

LR-20 LASER RIFLE

COSMIC UNIT

LOW RANKING OFFICER

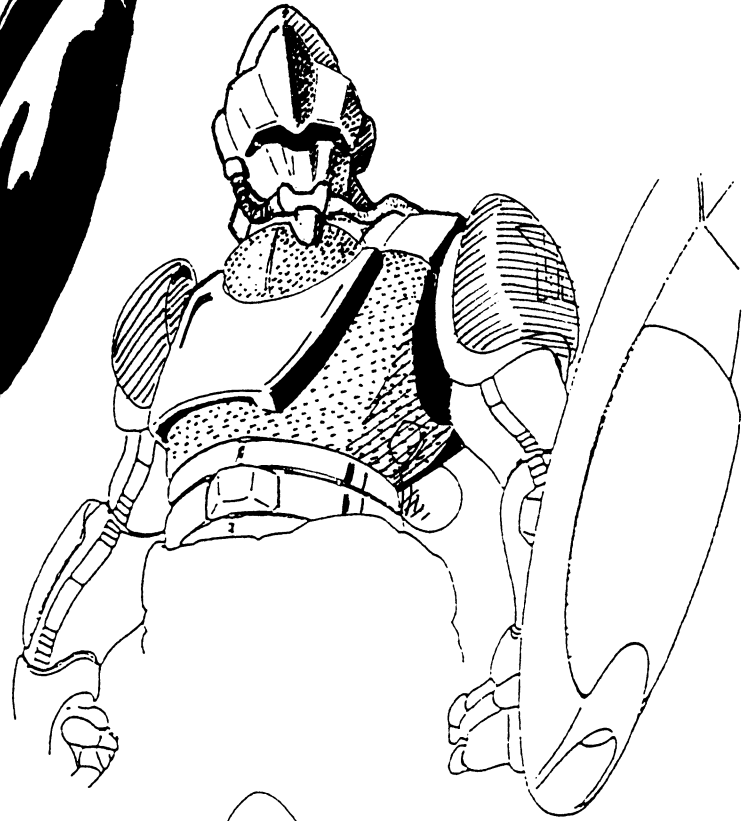
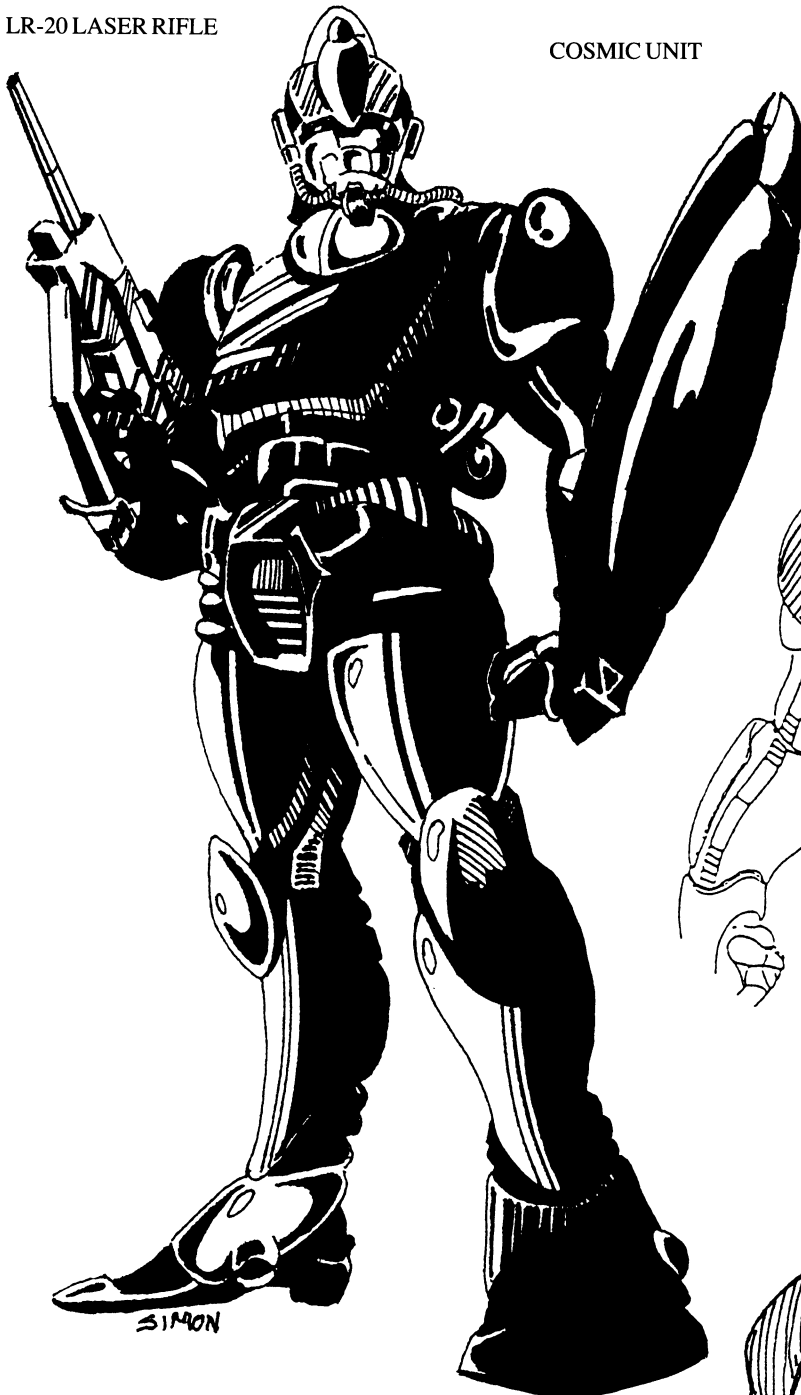

SOLDIER

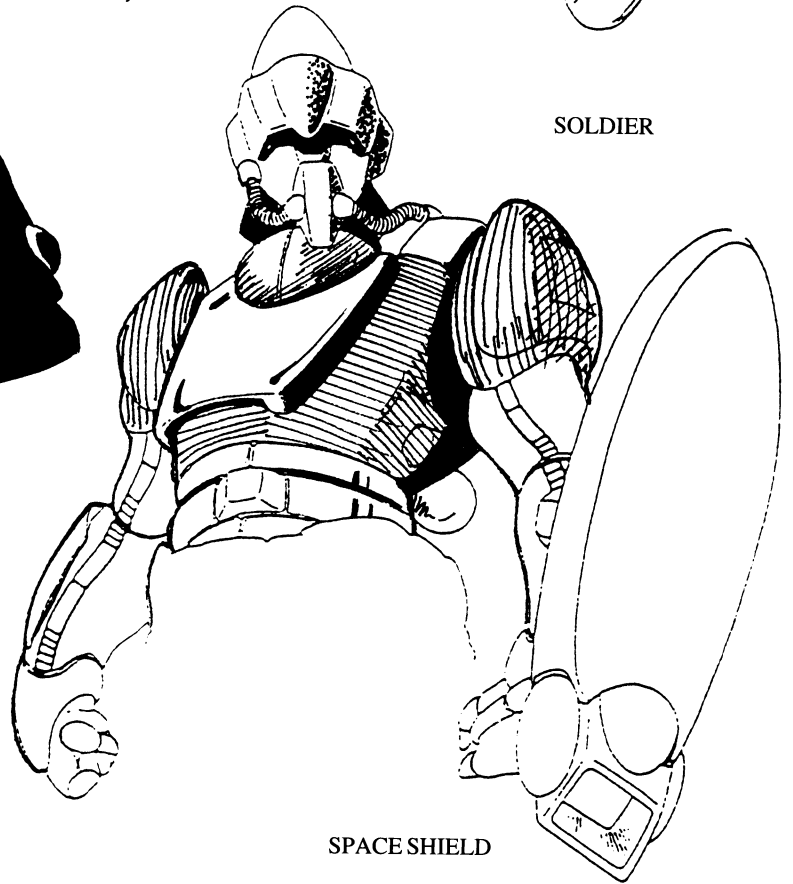

SPACE SHIELD

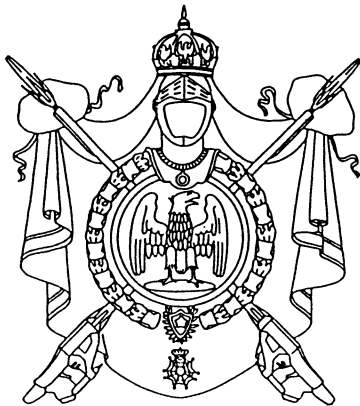

C.U. INSIGNIA

THE CIVIL DEFENSE UNIT (C.D.U)

The army of civil defense is composed of spit and polish soldiers whose purpose is public relations as much as it is combat. The C.D.U. are the urban police sent into a troubled city to protect it against an invader or itself. They provide high visibility to create a feeling of security among the civilian population.

To assume that the C.D.U. is a second-rate army is a mistake. These men and women are not only well trained soldiers but urban guerrillas. Their battleground is the city and they know how to operate within it.

MALE OFFICER

C.D.U. INSIGNIA



LIGHT
COMBAT SHIELD

LOW RANKING OFFICER

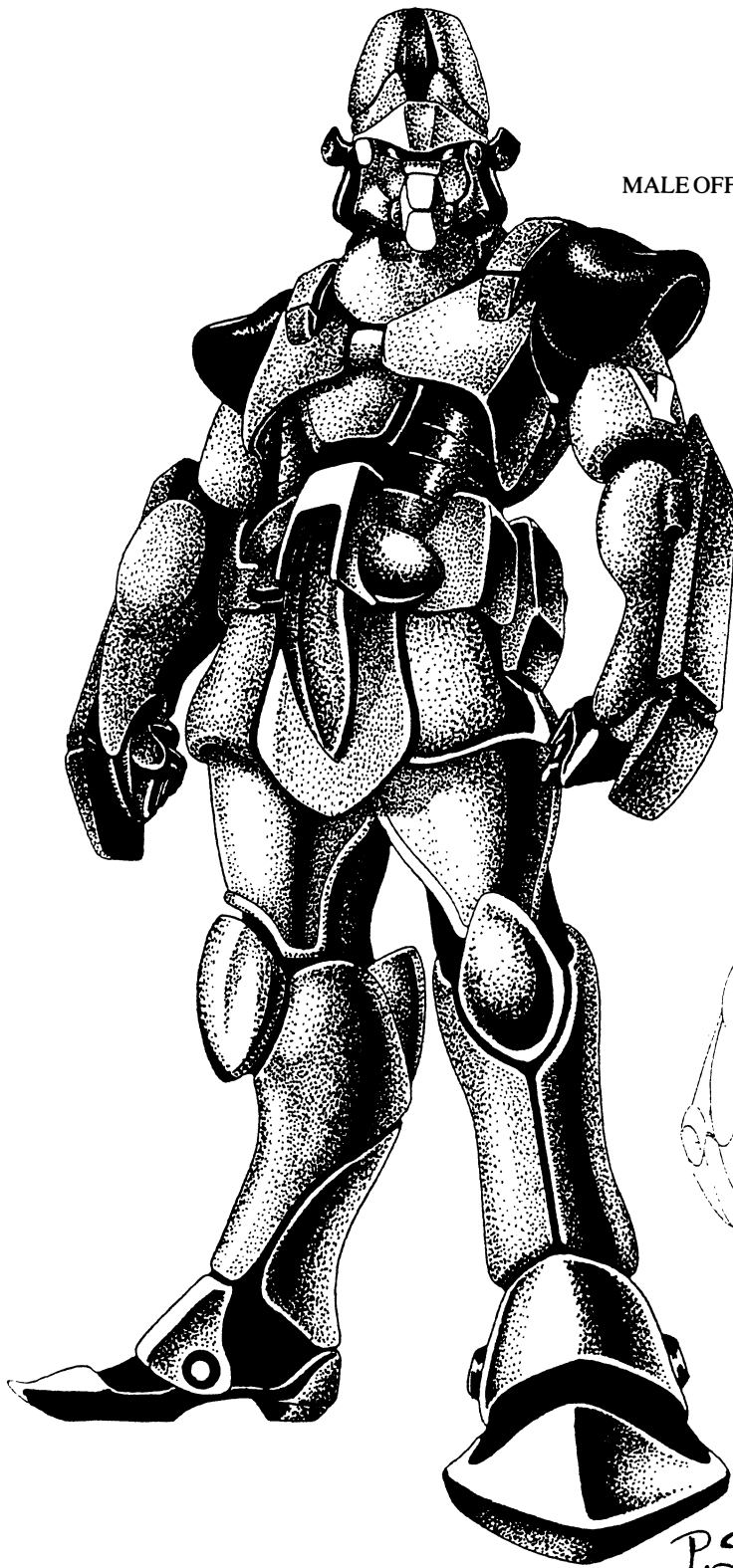

P. Simon
87

SOLDIER

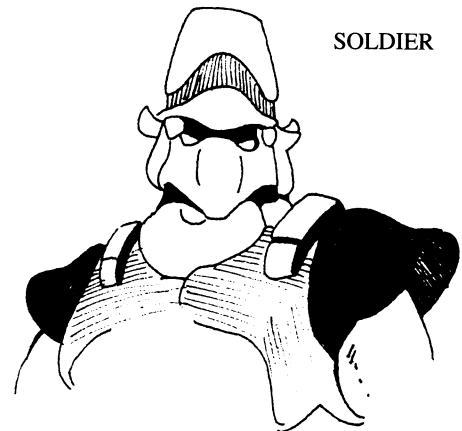

CIVIL DEFENSE UNIT O.C.C.

The C.D.U. is the army foremost in the mind of the people. They represent law, order, justice, security and strength. In addition to combat, the C.D.U. works with the people to establish a chain of communication, maintain medical and transport facilities, and defensive procedures under conditions of war.

As the people's tangible link to the military, the C.D.U. tries to recruit capable, exemplary soldiers. Soldiers who will conduct themselves with restraint, understanding and compassion. The C.D.U. also acts as a ground support army, following the Tactical Corp or armored divisions into combat.

Since the C.D.U. often has to operate without the support of the other offensive armies, and because they must function in a civilian environment, they have battloids.

The C.D.U. utilizes battloids (non-transformable mecha) more than any other army. The use of the Southern Cross' smaller (20ft/6.1m) sized battloids is ideal for an urban environment. The humanoid shape allows for superior mobility, protection and power. A sort of walking tank. This is especially important since the C.D.U. is often on its own as the last line of defense, or the only civilian/city defense available during wartime.

In addition to the O.C.C. skills listed with bonuses, the player must select an area of military specialty (MOS) and "other" skills. These skills are limited only as listed.

Attribute Requirements: A high mental affinity (MA) and physical strength are preferred, but not prerequisites.

O.C.C. Skills:

Pilot: Automobile

Pilot: Hover Cycle (+5%)

Mecha: Battloid

Radio: Basic (+5%)

Medical: Paramedic (+10%)

*Hand to Hand: Basic

W.P. Blunt

W.P. Energy Pistol

*Hand to Hand Basic can be upgraded to Expert at the cost of one "other" skill or to martial arts at the cost of two "other" skills.

M.O.S. Skills:

Any one M.O.S. category of skills, except Military Intelligence and Weapons, can be selected.

Other Skills: Select 10 Other Skills

Communication: Any (+5%)

Domestic: Any (+5%)

Electrical: Basic Electronics Only

Espionage: None

Mechanical: Auto Mechanics Only

Medical: None (other than the O.C.C. Paramedic skill)

Physical: Any

Pilot: Any Land Vehicle

Pilot Related: Any

Science: Basic and Advanced Mathematics Only

Technical: Any

W.P.: Any

Authorized Clearance Upon Assignment: Land or air vehicle, battloid, explosives, heavy weapons, riot control (gases/smoke), surveillance equipment and access to special personnel and equipment.

Standard Equipment: One regularly assigned hover cycle, or conventional ground vehicle, C.D.U. custom-fitted body armor, heavy combat shield, standard back pack, heavy utility belt, PPL-12 Lancer laser pistol, Putman stun-gun, nightstick, handcuffs, flashlight, wrist radio and uniform. If part of a battloid unit, a C.D.U. light or heavy battloid will be regularly assigned.

Monthly Wages: 1800 per month for enlisted men at level 1-5; 6th level and higher is 2400 credits, while officers receive 2800 to 3600 credits per month.

Personal Savings: 3D6 × 100 credits.

THE CIVIL DEFENSE FLYING CORP (C.D.F.C.)

The C.D.F.C. works with the Civil Defense Unit to police and defend non-military outposts and cities. The fundamental concepts surrounding the army for civil defense are unchanged. The difference is simply that the C.D.F.C. is a tactical air unit.

THE CIVIL DEFENSE FLYING CORP O.C.C.

The orientation of the C.D.F.C. is reconnaissance, observation, action and speed, through flight. Soldiers of the Flying Corp buzzing around skyscrapers and through alleyways like mad hornets are a common sight. The jet pack attachment to the body armor is a superb personal means of transportation, especially in the confines of the city. The flying units are so effective that they have been nicknamed "the eyes of the Civil Defense Corp."

The most often deployed modes of flight are helicopters and jet pack. Other aircraft, including older jet fighters like the L.V.T. Adventurer II, are also used in conflicts beyond the perimeter of the city. The Commanchero and Sea-Sergeant assault helicopters have become two of the main assault vehicles of the C.D.F.C. Battloids are rarely used by this civil defense army.

In addition to the O.C.C. skills listed with bonuses, the player must select an area of military specialty (M.O.S.) and "other" skills. These skills are limited only as listed.

Attribute Requirements: A high Mental Affinity (MA) and Physical Prowess (PP) is preferred, but not required.

O.C.C. Skills:

Pilot: Helicopter (+10%)

Pilot: Jet (+10%)

Pilot: Jet Pack (+5%)

Navigation (+5%)

Read Sensory Instruments (+15%)

Weapon Systems (+5%)

*Hand to Hand: Basic

W.P. Blunt

W.P. Energy Pistol

*Hand to Hand Basic can be upgraded to Expert at the cost of one "other" skill, or to Martial Arts at the cost of two "other" skills.

M.O.S. Skills:

Any one M.O.S. category of skills, except Military Intelligence and Weapons, can be selected.

Other Skills: Select 8 Other Skills

Communications: Any (+5%)

Domestic: Any

Electrical: Basic Electronics Only

Espionage: None

Mechanical: Auto or Aircraft Mechanics Only

Medical: First Aid Only

Physical: Any

Pilot: Any

Pilot Related: Any

Science: Math Only

Technical: Any except Demolitions

W.P.: Any

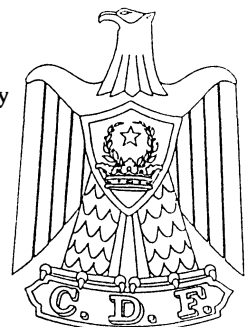

Authorized Clearance Upon Assignment: Land or air vehicle, explosives, heavy weapons, riot control, and access to assault aircraft and special equipment.

Standard Equipment: One regularly assigned helicopter (*may* include a Commanchero), C.D.F.C. custom-fitted body armor, light combat shield, standard back pack, standard utility belt, P-20 pulse laser pistol, Putman stun-gun, nightstick, handcuffs, flashlight, wrist radio (short range — 8 miles), jet pack and uniform.

Monthly Wages: 2000 credits per month for enlisted men at level 1-5; 6th level and higher is 2400 credits, while officers receive 3000 to 4000 credits per month.

Personal Savings: 3D6 × 100 credits.

LOW RANKING OFFICER

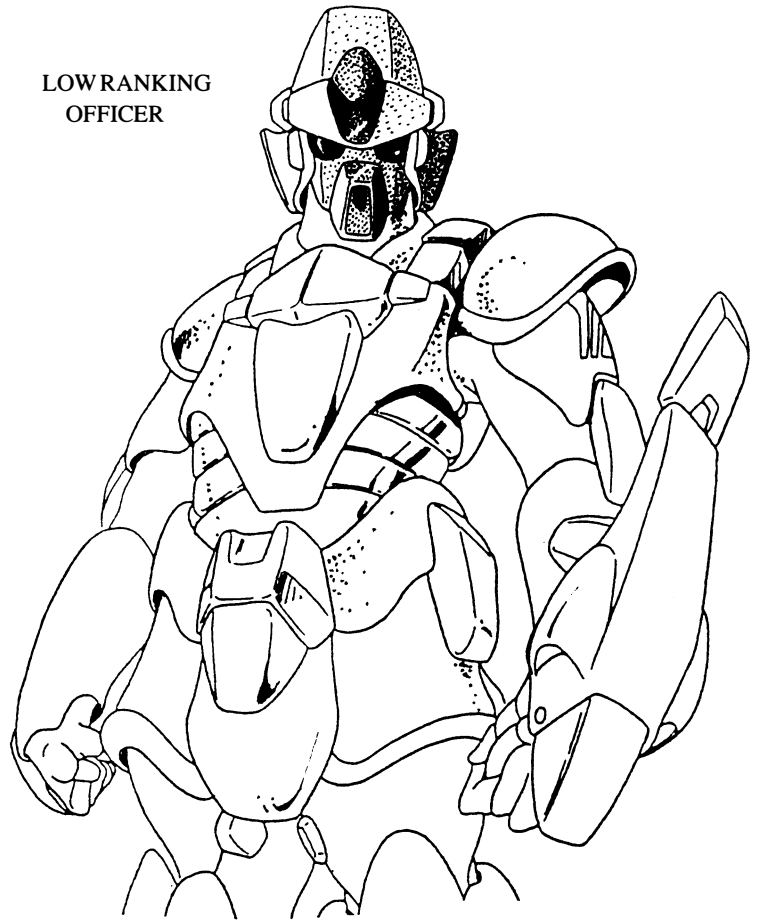

C.D.F.C. MALE OFFICER

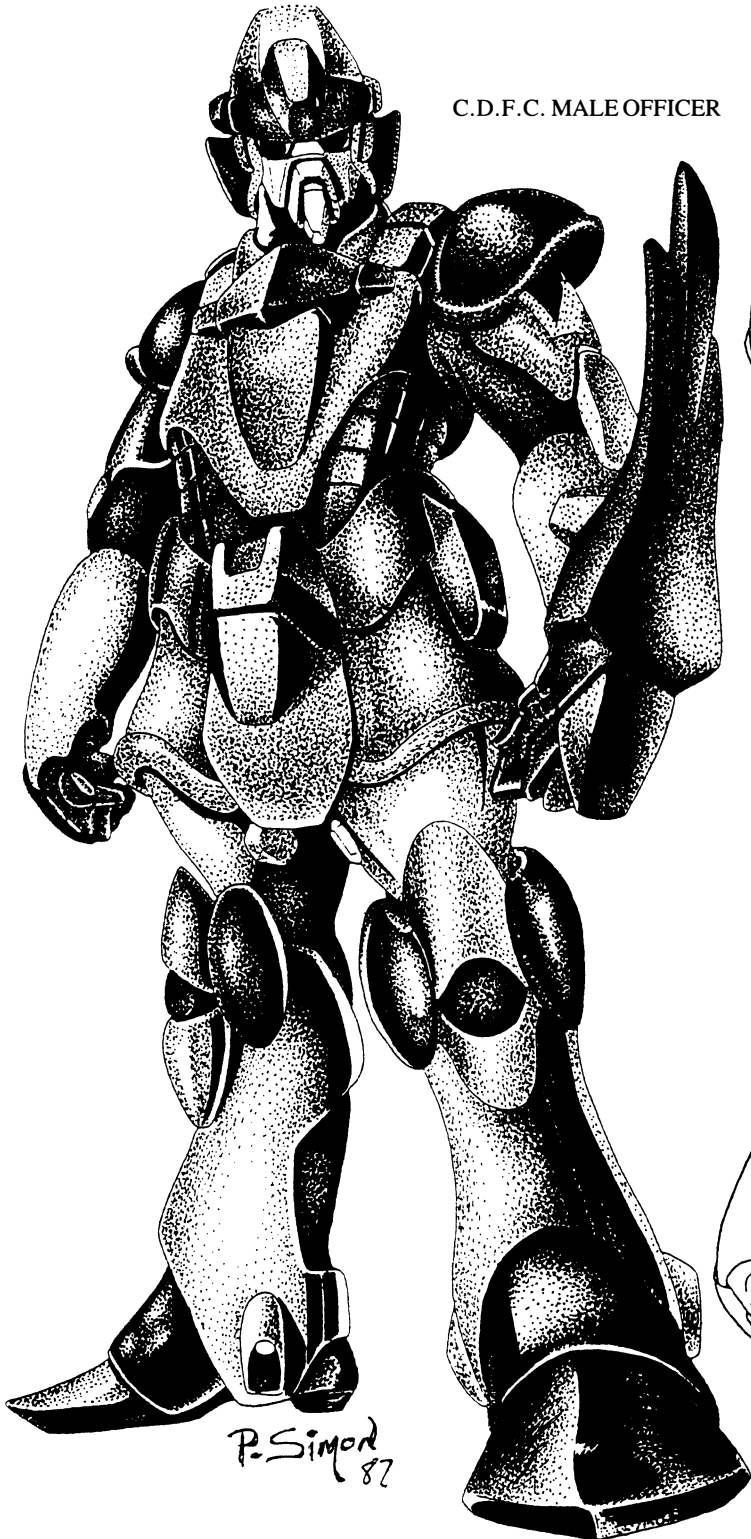

SOLDIER

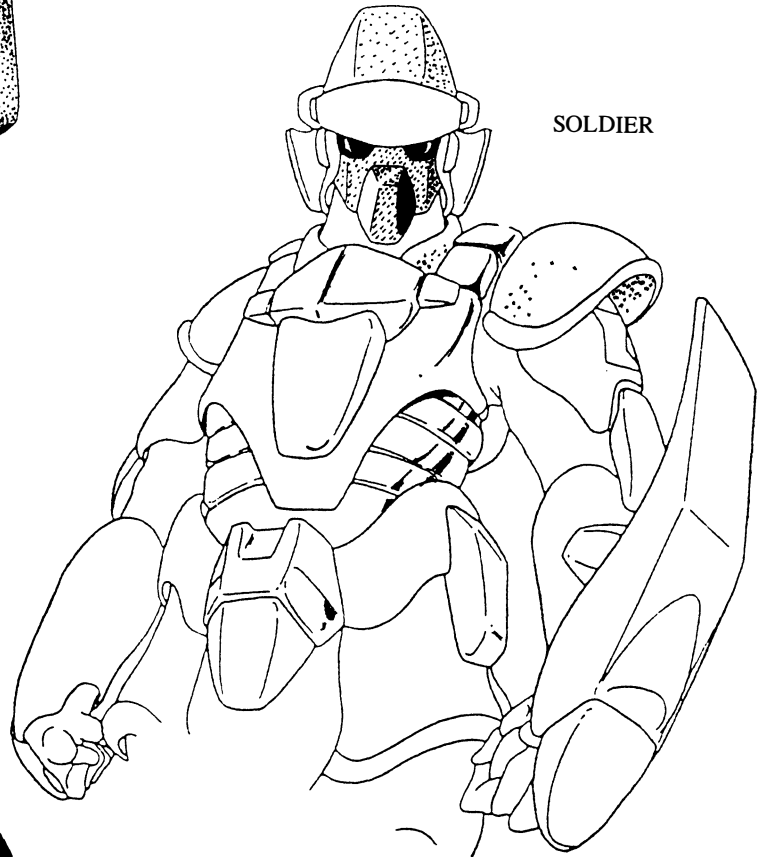

COLD WEATHER OFFENSIVE SQUAD (C.W.O.S.)

The C.W.O.S. is an army specially trained for operation in frigid wastelands and icy tundra. They can be found in and around polar regions and Scandinavia Quadrant.

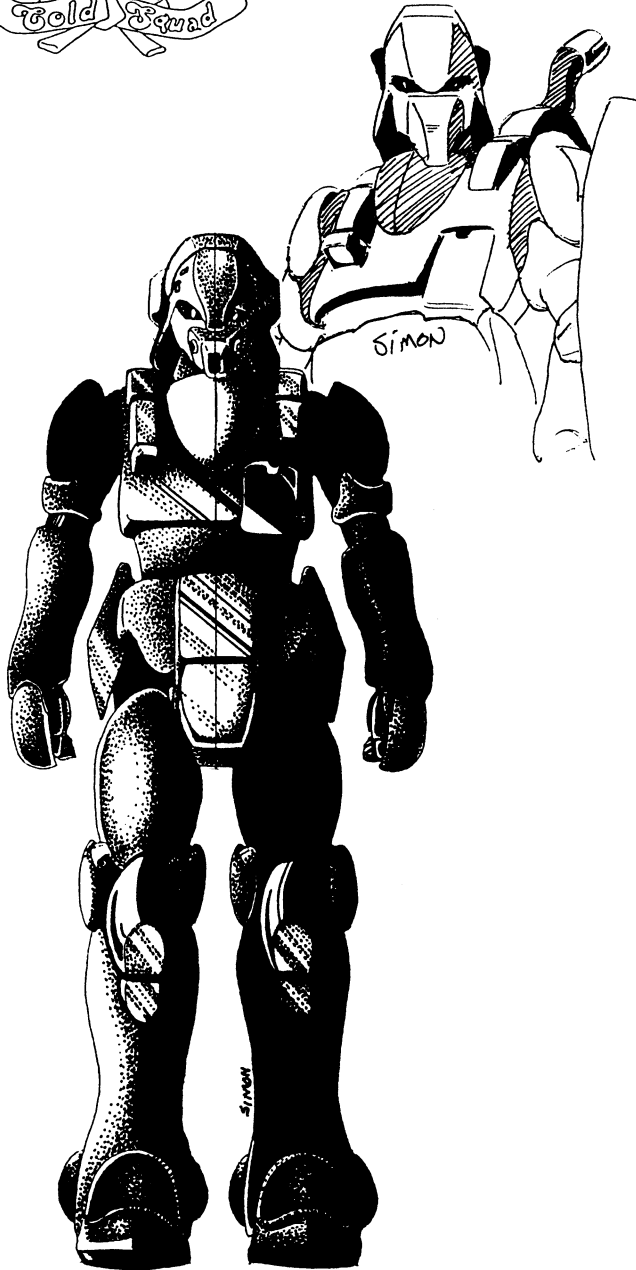
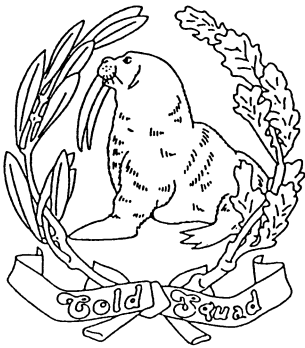

C.W.O.S. MALE OFFICER

COLD WEATHER OFFENSIVE SQUAD O.C.C.

These characters are wilderness and survival specialists trained for forbidding arctic environments. Their body armor is specifically designed for sub-zero weather. Additional insulation and a heating/cooling system regulates the internal temperature at a steamy, 60 to 70 degrees fahrenheit. The helmet visor is filtered to protect against snow blindness. Also, night falls quickly in the arctic, with a darkness city people can not imagine. Thus, a small light is mounted in the right breastplate of the armor for reading and close work. A large searchlight is built into the cold weather utility belt along with its temperature controlled compartments.

The C.W.O.S. soldier can learn to pilot a battloid, but can NOT take the massive, heavy mecha into the wilderness. Battloids and all land based mecha are too heavy, slow and awkward under arctic conditions. The giant machines are useful only at a city or military base where they can patrol the perimeter and assist in labor.

In addition to the O.C.C. skills listed with bonuses, the player must select an area of military specialty (MOS) and "other" skills. These skills are limited only as follows:

Attribute Requirements: I.Q. 8 or higher is preferred.

O.C.C. Skills:

Land Navigation (+20%)
Wilderness Survival (+15%)
Track (in arctic terrain only) (+15%)
Medical: Paramedic (+10%)
Swimming (+5%)

*Hand to Hand: Basic

W.P. Knife
W.P. Energy Pistol
W.P. Energy Rifle

*Hand to Hand Basic can be upgraded to Expert at the cost of one "other" skill, or to Martial Arts at the costs of two "other" skills.

M.O.S. Skills:

Any one M.O.S. category of skills, except Military Intelligence, can be selected.

Other Skills: Select 8 Other Skills

Communication: Any
Domestic: Any
Electrical: Basic Electronics Only
Espionage: None
Mechanical: Automotive Mechanics Only
Medical: None other than the O.C.C. Paramedic skill.
Physical: Any
Pilot: Land Vehicles Only
Pilot Related: Any
Science: Any
Technical: Any
W.P.: Any

Authorized Clearance Upon Assignment: Land vehicles, explosives, heavy weapons, battloid, and access to special personnel and equipment.

Standard Equipment: One regularly assigned vehicle (usually hover-type), C.W.O.S. custom-fitted body armor, heavy combat shield, survival kit back pack, cold weather utility belt, PPL-12 Panther pulse laser pistol, LR-20 laser rifle, wrist radio (short range — 8 miles), 200ft (61.m) of nylon cord with grappling hook attachment, 6 signal flares, infrared distancing binoculars, 6 weeks of food rations and snowshoes. At least one member of the group should have a portable scan dililator.

Monthly Wages: 2100 credits per month for enlisted men at level 1-5; 6th level and higher is 2700 credits per month, while officers receive 3200 to 4400 credits per month.

Personal Savings: 5D6 × 100 credits.

HUMID CLIMATE OFFENSIVE SQUAD

H.C.O.S. INSIGNIA

MALE OFFICER



LOW RANKING OFFICER



SOLDIER

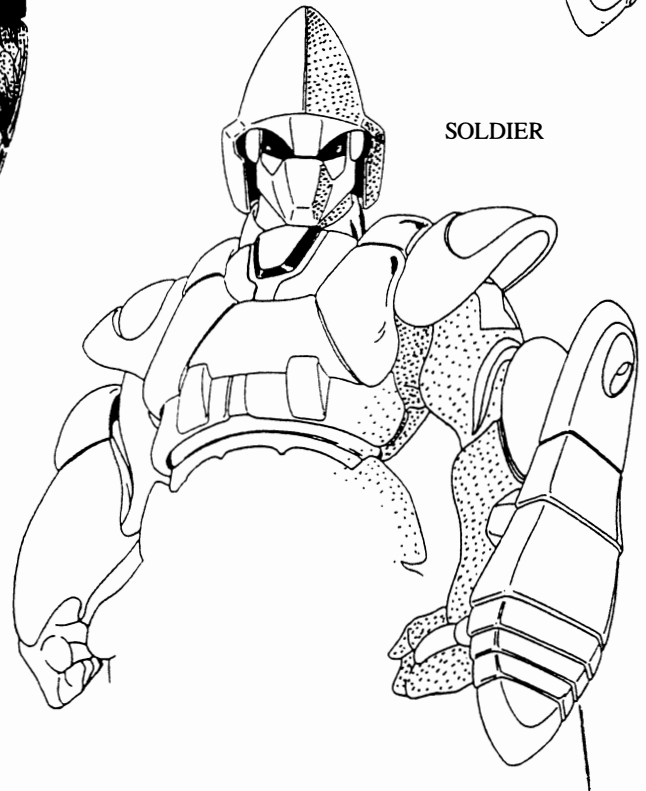

HEAVY COMBAT SHIELD

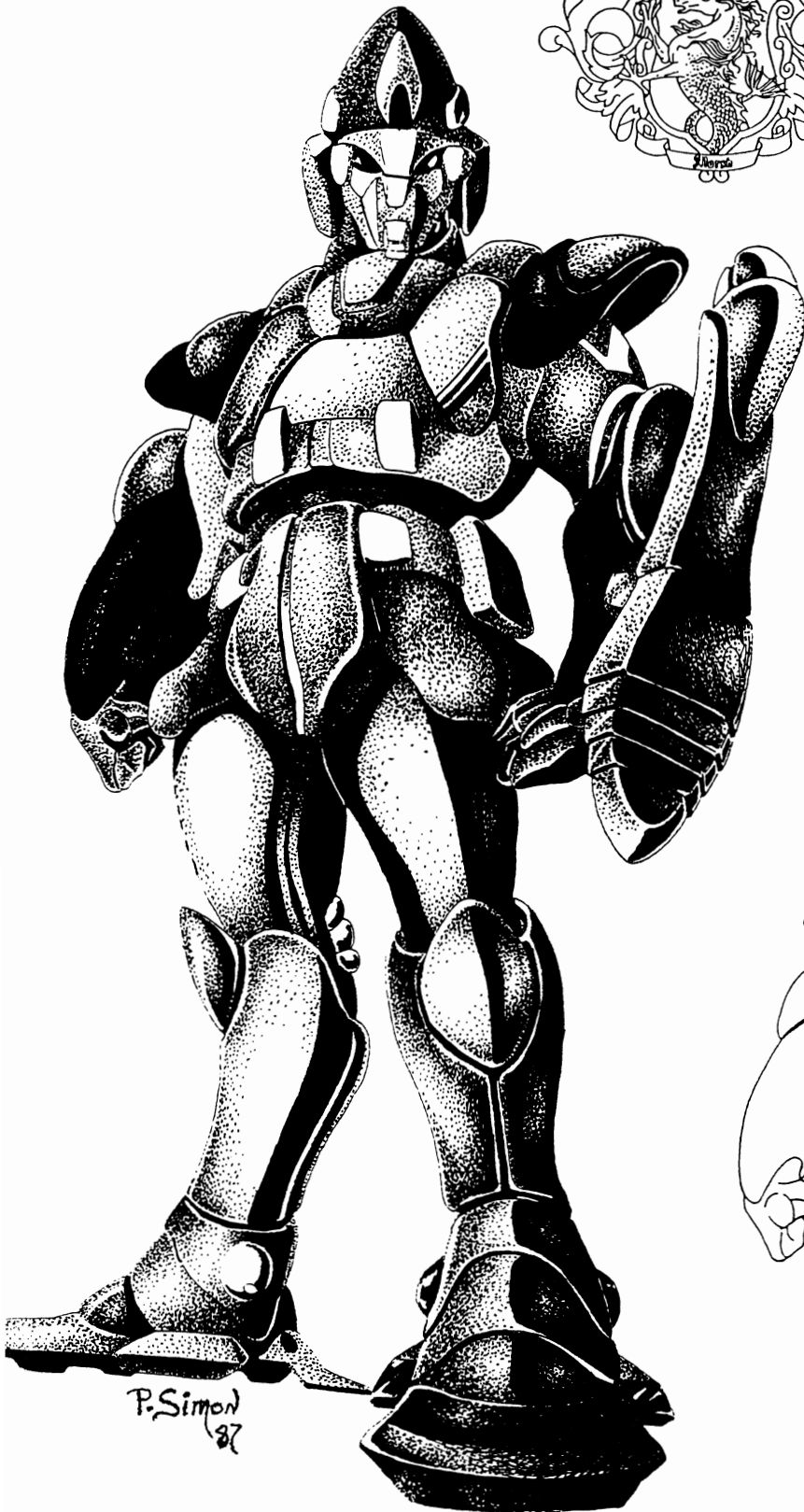

P. Simon
87

HUMID CLIMATE OFFENSIVE SQUAD (H.C.O.S.)

The H.C.O.S. is another army trained to operate under particular conditions and environments. Humid climates specifically refer to subtropical and swamp conditions. Consequently, these troops are scattered around the world at such notable places as the old state of Florida, Mediterranean islands, and parts of Africa and India.

HUMID CLIMATE OFFENSIVE SQUAD O.C.C.

The H.C.O.S. are like the United States Green Berets, trained for deadly, first strikes and special operations. Although the H.C.O.S. can operate in any environment, they are most familiar with marshy, subtropical conditions. They are masters of camouflage and infiltration.

The H.C.O.S. character can elect to learn battloid skills, but is really more of a foot soldier. Battloids are difficult to conceal during recon or clandestine operations.

In addition to the O.C.C. skills listed with bonuses, the player must select an area of military specialty (MOS), as well as "other" skills. These skills are limited as follows:

Attribute Requirements: P.S. 12; high P.P. is preferred as well, but not a prerequisite.

O.C.C. Skills

Disguise (+5%)

Escape Artist (+10%)

Wilderness Survival (+10%)

Land Navigation (+10%)

Prowl (+15%)

Hand to Hand: Martial Arts

W.P. Semi & Fully Automatic Rifle

W.P. Energy Pistol

W.P. Energy Rifle

M.O.S. Skills:

Skill categories are limited to Military Intelligence, Combat, Weapons, Pilot and Communications.

Other Skills: Select 8 Other Skills

Communications: Any

Domestic: Any

Electrical: Basic Electronics Only

Espionage: None (only available as a MOS)

Mechanical: Automotive Mechanics Only

Medical: First Aid or Paramedic*

Physical: Any (+10% on percentages, like swimming)

Pilot: Any Land Vehicles and Boats

Pilot Related: Any

Science: Math and Botany Only

Technical: Any (+5%)

W.P.: Any

**The Paramedic skills counts as two skills.*

Authorized Clearance Upon Assignment: Land vehicles, battloid, explosives, heavy weapons, surveillance equipment, and access to special equipment.

Standard Equipment: Custom-fitted H.C.O.S. body armor, heavy combat shield, heavy utility belt, survival kit back pack, survival knife, 9mm automatic pistol, PPL-12 Panther laser pistol, wrist radio and uniform.

Additional Equipment in the Field: Two additional weapons of choice (usually RFL-100 rapid-fire pulse laser and a tri-laser pistol), semi-automatic assault rifle, 3 to 12 cobalt grenades, 2 to 6 smoke grenades, 4 signal flares, 2 survival knives, night-vision scope, infrared distancing binoculars, 150 feet of nylon cord, grappling hook, and any other reasonable items which might be necessary for

the assignment.

Monthly Wages: 2100 credits per month for enlisted men at level 1-5; 6th level and higher is 2700 credits per month, while officers receive 3200 to 4400 credits per month.

Personal Savings: 4D6 × 100 credits.

MOUNTAIN OFFENSIVE SQUAD (M.o.S.)

A special force trained in the arts of mountain climbing, the M.o.S. can be found within the mountains of the world. From time to time, the skilled daredevils of the M.o.S. are called upon to perform less traditional feats, such as scaling skyscrapers, spacecraft and the crater pocked wastelands.

MOUNTAIN OFFENSIVE SQUAD O.C.C.

The Mountain Squad is trained in all types of climbing and scaling techniques. Generally they are called in for special assignments or placed as a member of a special team.

The body armor of the Mountain Squad is designed to address their specific needs for climbing. The shoulders are large, heavily reinforced compartments that contain a 100ft towline/rappelling line. On top of the shoulders, forearms, hips, knees, and back, are heavy, reinforced rope clips. The feet are ridged for better traction, and can be replaced with electromagnetic pads to scale metal surfaces.

Battloids are rarely used by the M.o.S., but battloid piloting and combat skills can be selected.

In addition to the O.C.C. skills listed with bonuses, the player must select an area of military specialty (M.O.S.), as well as "other" skills. These skills are limited only as follows.

Attributes Requirements: P.S. 10 or higher; a good P.P. is also handy, but not required.

O.C.C. Skills

Climbing (+20%)

Gymnastics

Demolitions (+5%)

Demolitions Disposal (+10%)

Wilderness Survival (+5%)

Land Navigation (+10%)

*Hand to Hand: Basic

W.P. Chain

W.P. Rifle

W.P. Energy Pistol

*Hand to Hand: Basic can be changed to expert at the cost of one additional skill, or to martial arts at the cost of two "other" skills.

M.O.S. Skills:

Skill categories are limited to Combat, Weapons, Science, Medical, Mechanical Engineer and Communications.

Other Skills: Select 9 Other Skills

Communications: Any

Domestic: Any

Electrical: Basic Electronics Only

Espionage: None

Medical: First Aid or Paramedic**

Mechanical: Auto Mechanic Only

Physical: Any

Pilot: Any Ground Vehicle

Pilot Related: Any

Science: Any

Technical: Any

W.P.: Any

***Paramedic skill counts as two skills.*

MOUNTAIN SQUAD

MALE OFFICER

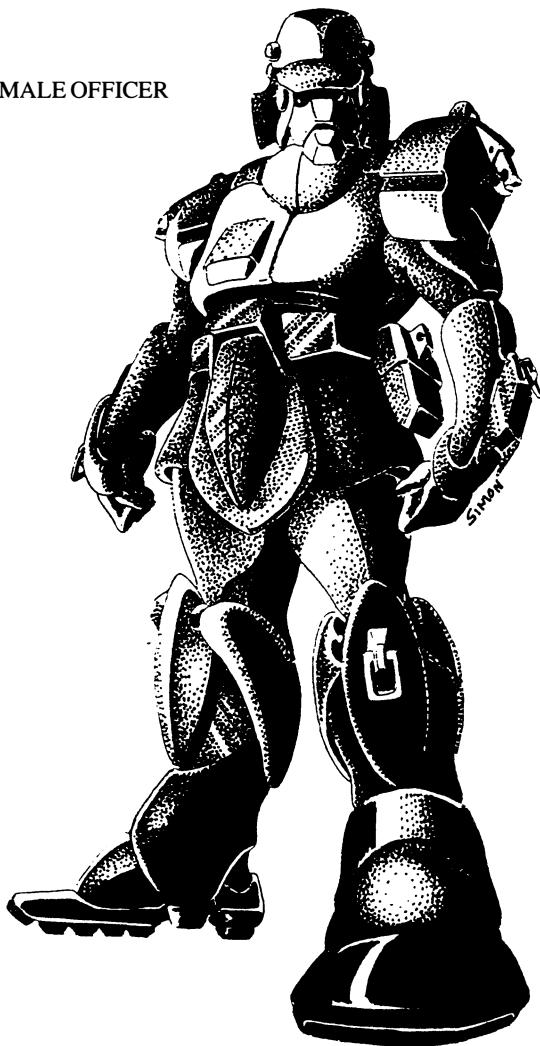

SOLDIER FRONT VIEW

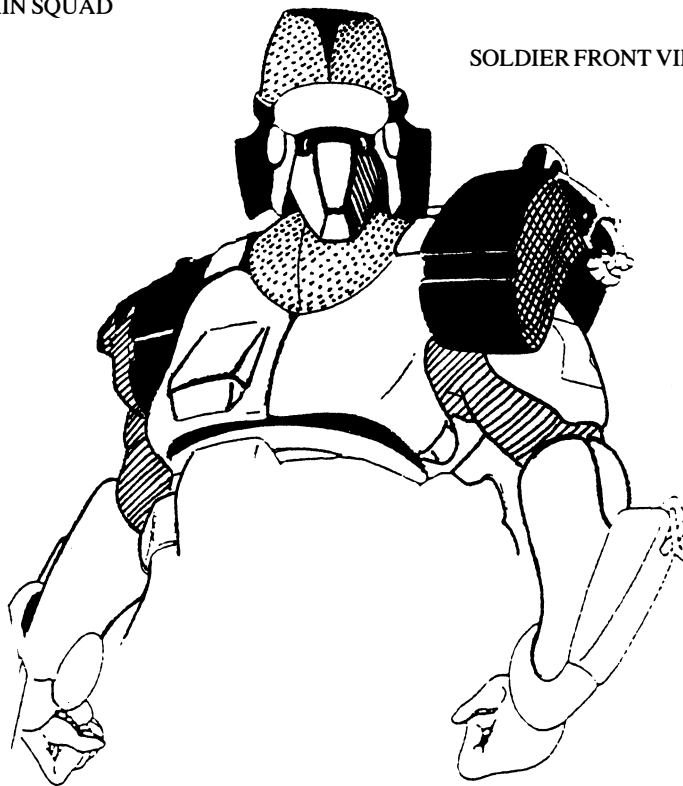

Authorized Clearance Upon Assignment: Land vehicles, battloid, explosives, heavy weapons, and access to special personnel and equipment.

Standard Equipment: Custom-fitted M.o.S. body armor (No combat shield), survival kit back pack, heavy utility belt, PPL-12 Panther pulse laser pistol, wrist radio (short range — 8 miles), uniform, survival knife, gloves, climbing boots and gear, 300ft (91m) rope, and electro-adhesive pads.

Monthly Wages: 2100 credits per month for enlisted men at level 1-5; 6th level and higher is 2700 credits per month, while officers receive 3200 to 4400 credits per month.

Personal Savings: 5D6 x 100 credits.

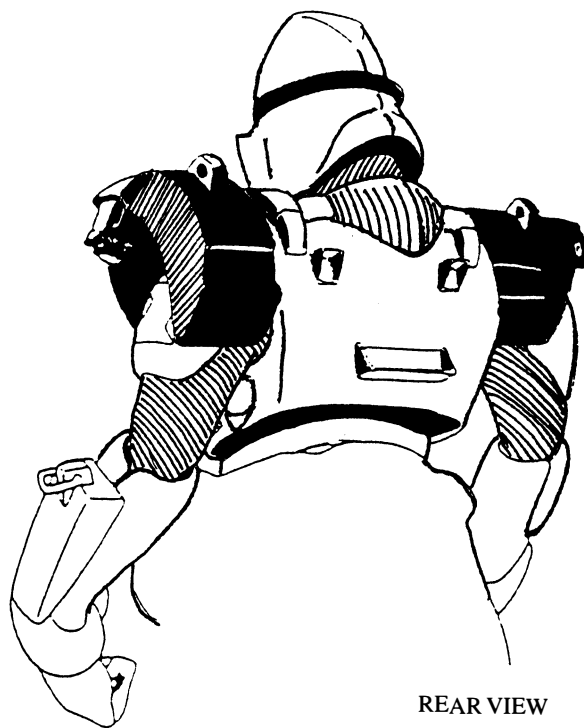

REAR VIEW



M.o.S. INSIGNIA

DESERT SQUAD (D.S.)

The Desert Squad is a ground force that patrols the vast wastelands and deserts of the world. The D.S. are savage fighters who relish the opportunity to engage in combat, especially hand to hand combat. Many of these men and women are ex-mercenaries and people who have eked out a modest living in the harsh, desolate outbacks. Many have fought Zentraedi and bandits. Many once were bandits. Yet despite their checkered past, most of the D.S. are loyal and trustworthy.

D.S. MALE OFFICER

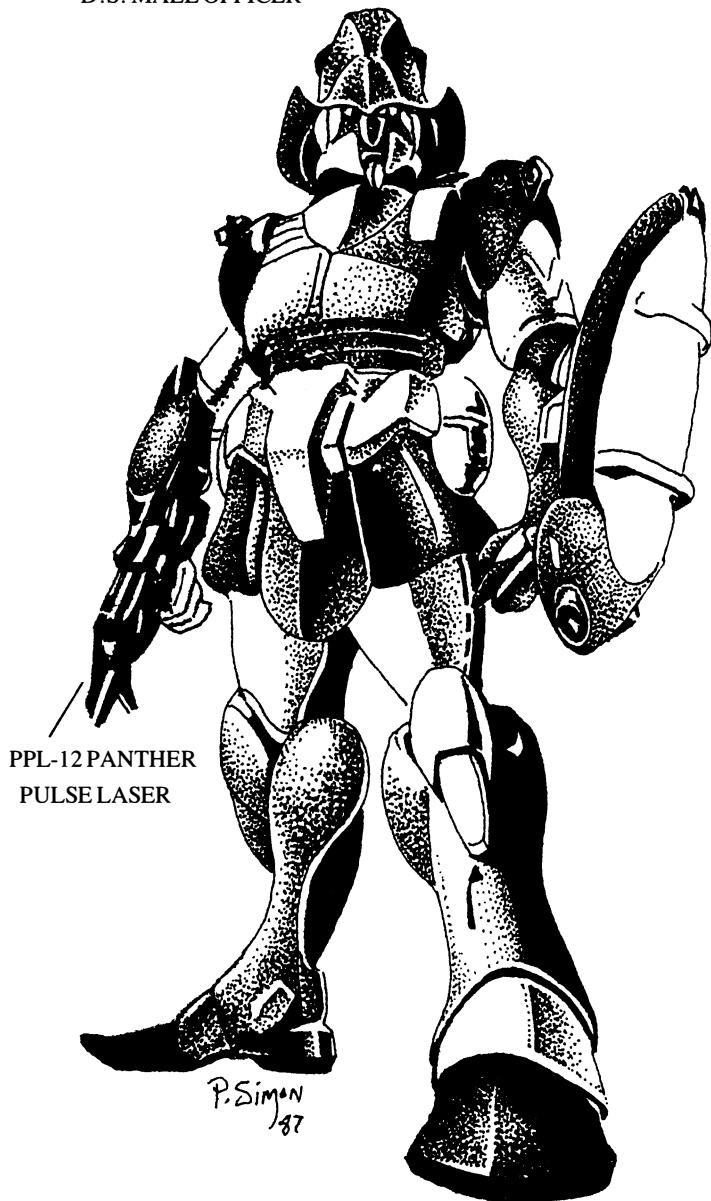

PPL-12 PANTHER
PULSE LASER

THE DESERT SQUAD O.C.C.

The Desert Squad character is a hard-boiled soldier who tends to think with his/her fists. Most are used to a hard life and think little of the bleak existence they endure. It is nearly 20 years since the Zentraedi laid waste to most of the planet, and still the crater filled wastelands are slow to return to life. Law and order are unknown in the land scorched by the Zentraedi onslaught. Nomads, hunters, bandits, rogue Zentraedi, and high-tech bandits, hide among twisted ruins and shattered earth. It is a harsh world. It is the world of the Desert Squad.

These characters can elect to pilot battloids (and take battloid combat), but tend to prefer man to man, hand to hand combat.

In addition to the O.C.C. skills listed with bonuses, the player must select an area of military specialty (MOS), as well as "other" skills. These skills are limited only as listed.

Attribute Requirements: P.S. 9, M.E. 9

O.C.C. Skills:

Pilot: Hover Cycle (+4%)
Detect Ambush (+5%)
Detect Concealment (+10%)
Wilderness Survival (+15%)

*Hand to Hand: Expert

W.P. Knife
W.P. Sub-Machinegun
W.P. Energy Pistol
W.P. Energy Rifle

*Hand to Hand Expert can be changed to Martial Arts for the cost of one "other" skill.

M.O.S. Skills:

Any one M.O.S. category of skills, except Military Intelligence, can be selected. The most common among the D.S. are Combat, Weapons, Pilot and Mechanical.

Other Skills: Select 8 Other Skills

Communications: Any

Domestic: Any

Electrical: Basic Electronics Only

Espionage: Pick Locks, Pick Pockets, Land Navigation, and Tracking Only (+10%)

Mechanical: Automotive Mechanics Only

Medical: First Aid or Paramedic (counts as two skills)

Physical: Any

Pilot: Any Land Vehicle

Pilot Related: Any

Science: Basic and Advanced Mathematics Only

Technical: Any

W.P.: Any

Authorized Clearance Upon Assignment: Land vehicles including hover-types, explosives, heavy weapons, surveillance or optical equipment, battloids and access to special equipment.

Standard Equipment: One regularly assigned vehicle (the RDF motorcycle, dune buggy and hover cycle seem to be the most popular choices), custom-fitted D.S. body armor, searchlight shield, survival kit back pack, hot weather utility belt, tri-laser pistol, L.P. Night-stalker pistol, PR-30 pulse rifle, wrist radio (short range — 8 miles), canteen, flashlight, infrared distancing binoculars, 6 signal flares, first-aid kit, survival knife and uniform.

Note: The D.S. are often issued the RFL-100 Rapid-Fire Pulse Laser when going on long or dangerous patrols. The armored land rover is commonly assigned to groups, although a choice of vehicles is usually available. The D.S. are also allowed to carry and use any number of *non-military* issued weapons. These non-standard items most commonly consist of sub-machineguns, pistols, revolvers, throwing knives, throwing axes, swords, nunchaku, cudgel, and quarterstaff.

Monthly Wages: 1900 credits per month for enlisted men at levels 1-5; 6th level and higher 2500 credits per month; while officers receive 3100 to 4100 credits per month.

Personal Savings: 3D6 × 100 credits.

Note: The other, more formal, Armies of the Southern Cross look upon the D.S. as uncouth ruffians who lack proper discipline.

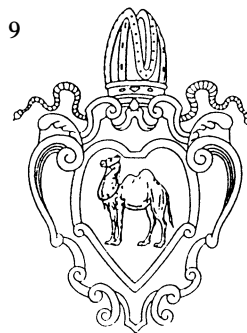

MALE OFFICER

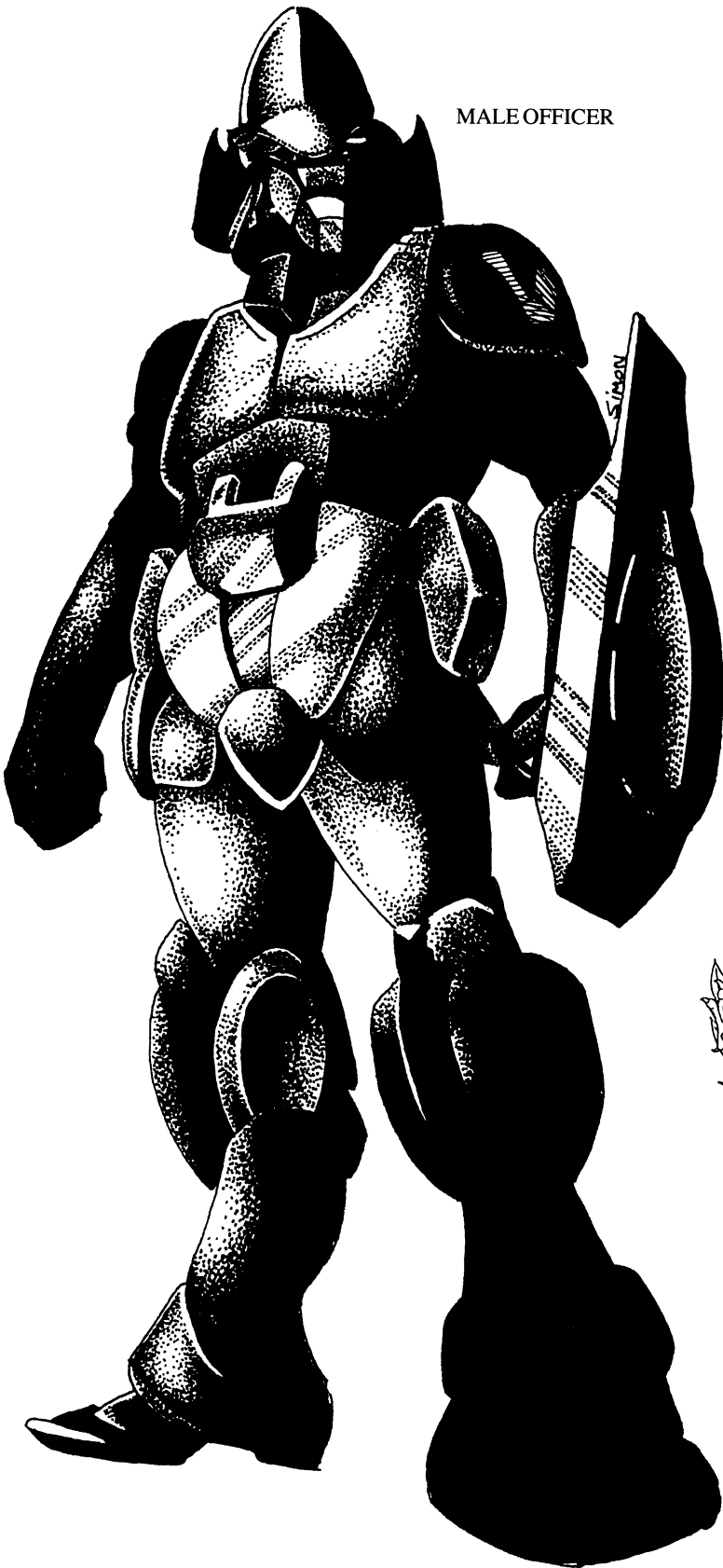

FRONT VIEW

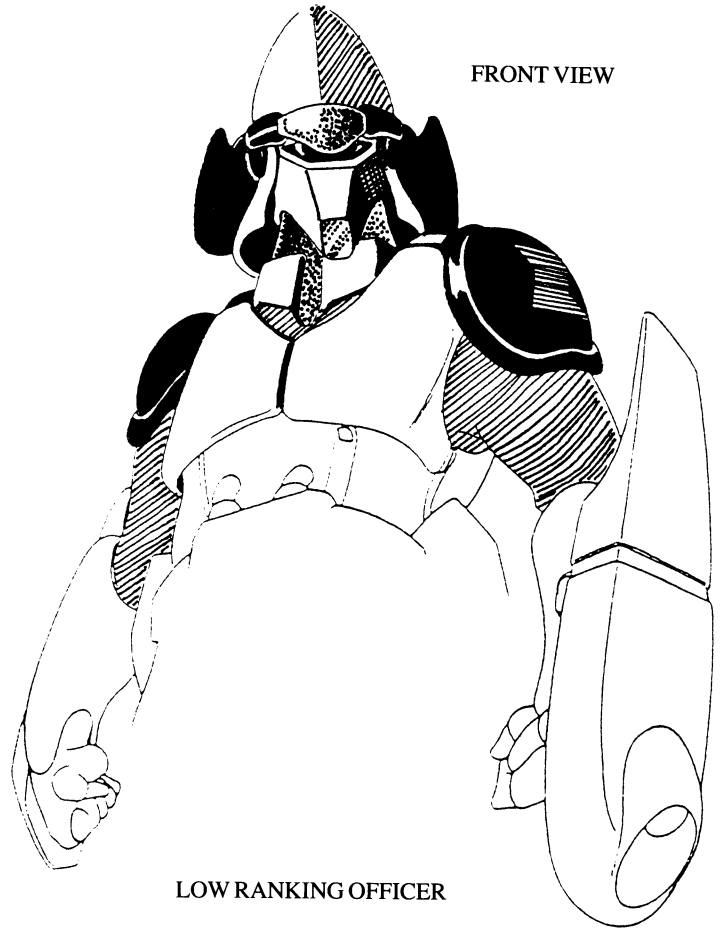

LOW RANKING OFFICER

J.S. INSIGNIA



SPOT LIGHT SHIELD

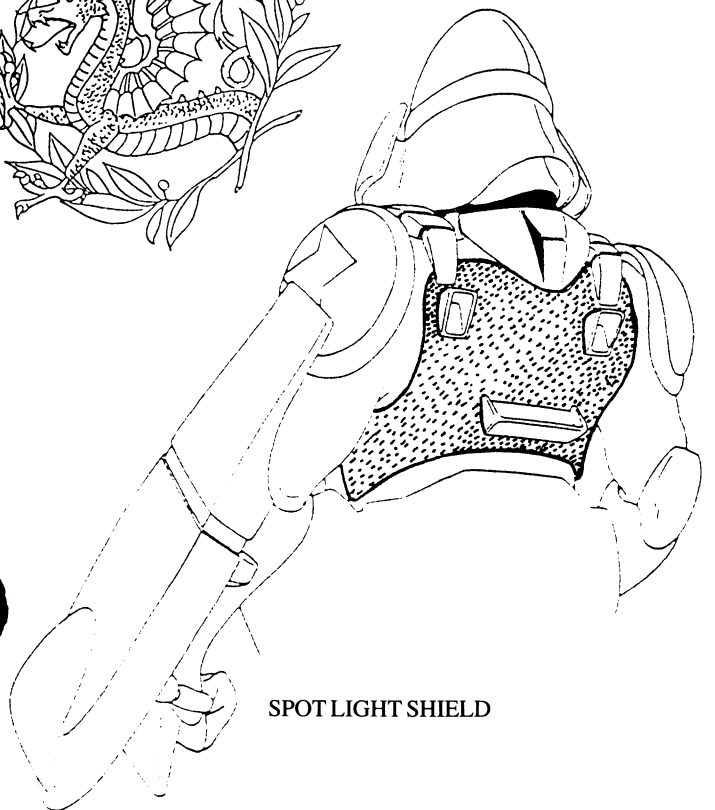

JUNGLE SQUAD (J.S.)

The soldiers of the Jungle Squad are experts in jungle survival and operations. Their primary purpose is combat and intelligence. Troops are currently stationed in the Amazon jungle of the South American Sector, China, Indochina and Indonesia Quadrants.

THE JUNGLE SQUAD O.C.C.

The J.S. are capable jungle fighters, familiar with commando and guerrilla tactics. Assignments can be reconnaissance, assault, rescue, intelligence, escort, track a fugitive, or search and destroy. The J.S. rarely use battloids, but the characters can elect to choose pilot battloid and battloid combat.

In addition to the O.C.C. skills listed with bonuses, the player must select an area of military specialty (M.O.S.), as well as "other" skills. These skills are limited only as follows.

Attribute Requirements: P.E. 9; P.S. 8 or higher.

O.C.C. Skills:

Detect Ambushes (+10%)

Detect Concealment (+10%)

Wilderness Survival (+10%)

Land Navigation (+10%)

Climbing

*Hand to Hand: Expert

W.P. Sword

W.P. Semi & Fully Automatic Rifle

W.P. Energy Pistol

*Hand to Hand Expert can be changed to Martial Arts for the cost of one "other" skill.

M.O.S. Skills:

Any M.O.S. category of skills, except Military Intelligence, can be selected.

Other Skills: Select 10 Other Skills

Communications: Any

Domestic: Any

Electrical: Basic Electronics Only

Espionage: None

Mechanical: Auto Mechanics Only

Medical: First Aid Only

Physical: Any

Pilot: Any Land Vehicle Only

Pilot Related: Any (+5%)

Science: Basic and Advanced Mathematics Only

Technical: Any (+5%)

W.P.: Any

Authorized Clearance Upon Assignment: Land vehicles, battloid, explosives, heavy weapons, and access to special personnel and equipment.

Standard Equipment: Custom-fitted J.S. body armor, searchlight shield, survival kit back pack, hot weather utility belt, L.P. Night-stalker pistol, PR-30 pulse rifle, short sword (machete type), wrist radio (short range — 8 miles), 4 signal flares, flashlight, survival knife, infrared distancing binoculars, tent, 150ft (45m) rope and uniform.

Monthly Wages: 2000 credits per month for enlisted men at levels 1-5; 6th level and higher is 2600 credits per month, while officers receive 3000 to 4200 credits per month.

Personal Savings: 3D6 × 100 credits.

THE SEA SQUAD (S.S.)

The Navy branch of the military is the Sea Squad. The Sea Squad patrols the seas and oceans of the world. A variety of conventional warships and submarines are deployed, as well as 4 SLV Beachmaster Class Vessels and 9 CVS Submersible Aircraft Carriers (See the *RDF Manual*, pgs 15-23, for details).

THE SEA SQUAD O.C.C.

Characters in this branch of the service are highly skilled in underwater combat and exploration. They engage in underwater reconnaissance, rescue, combat, demolitions and recovery. Currently, an experimental underwater city, off the northwest coast of the Australia Quadrant, absorbs most of the Sea Squad's attention. The majority of the fleet can be found in waters of the Eastern Sector.

The Sea Squad has little need for mecha, but do utilize battloids and the Logan (piloted by T.A.S.C.) on the giant warships and major land bases. Consequently, the character can select battloid pilot and combat skills.

SPECIAL WEAPONS

The SP-10 Shark is a double barreled, self-loading projectile weapon suitable for underwater combat. The weapon can either fire harpoon-type shafts, or explosive, armor piercing projectiles. **Weight:** 5lbs (2.3kg); **Effective Range Underwater:** 300ft (91m, for the harpoon), 600ft (183m, for the projectiles). **Damage:** 4D6 S.D.C. (not M.D.C.) with each *pair* of harpoons, or 1D4 M.D. with explosive projectiles. **Cost:** 1000 credits. **Feed:** 20 harpoons, or 10 armor piercing explosive projectiles.

SP-Discus is an unusual underwater projectile weapon that fires a small, whirling, explosive disc. **Weight:** 8lbs (3.6kg); **Effective Range:** 600ft (183m); **Damage:** 1D6 M.D. **Cost:** 1400 credits. **Feed:** 20 explosive discs.

In addition to the O.C.C. skills listed with bonuses, the player must select an area of military specialty (MOS), as well as "other" skills. These skills are limited only as listed.

Attribute Requirements: M.E. 11 or higher.

O.C.C. Skills:

Pilot Boat (all) (+10%)

Swimming

Swimming: S.C.U.B.A.

Underwater Demolitions (+5%)

Underwater Demolitions Disposal (+10%)

*Hand to Hand: Basic

W.P. Knife

W.P. Staff/Spear

W.P. Semi & Fully Automatic Rifle (this includes the two underwater weapons).

*Hand to Hand Basic can be changed to Expert at the cost of one "other" skill.

M.O.S. Skills:

Any one M.O.S. category of skills, except Military Intelligence and Weapons, can be selected.

Other Skills: Select 8 Other Skills

Communications: Any (+5%)

Domestic: Any

Electrical: Basic Electronics Only

Espionage: None

Mechanical: Automotive Mechanics Only

Medical: First Aid Only

Physical: Any

Pilot: Any Land or Water Vehicle

Pilot Related: Any (+5%)

Science: Basic and Advanced Mathematics Only

Technical: Any
W.P.: Any

Authorized Clearance Upon Assignment: Vehicles, battloid, explosives, heavy weapons, and access to special personnel and equipment.

Standard Equipment: Custom fitted Sea Squad body armor (no combat shield), cold weather-type utility belt, space booster pack (suitable for underwater), 9mm automatic pistol (sidearm), wrist radio, uniform, wet-suit, S.C.U.B.A. gear and survival knife.

Monthly Wages: 2000 credits per month for enlisted men at level 1-5; 6th level and higher get 2600 credits, while officers receive 3000 to 4000 credits per month.

Personal Savings: 4D6 × 100 credits.

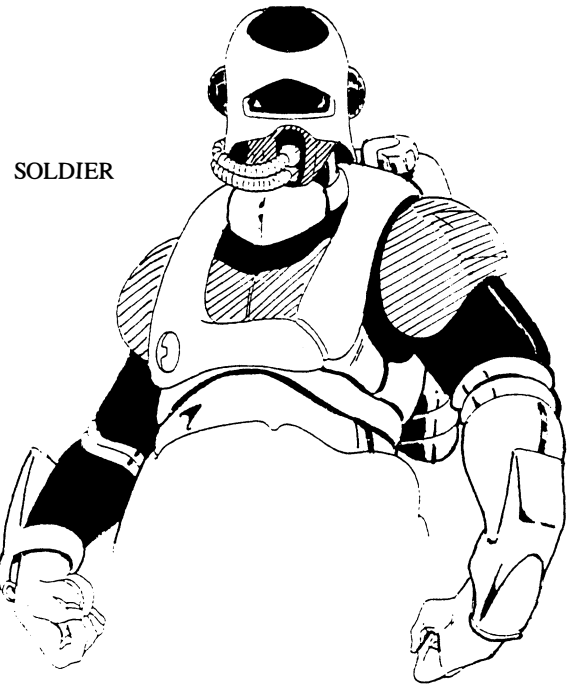

SOLDIER

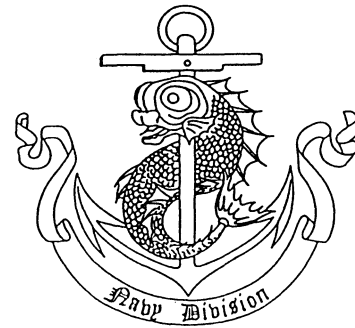

S.S. INSIGNIA



SEA SQUAD

SP-10 SHARK

MALE OFFICER

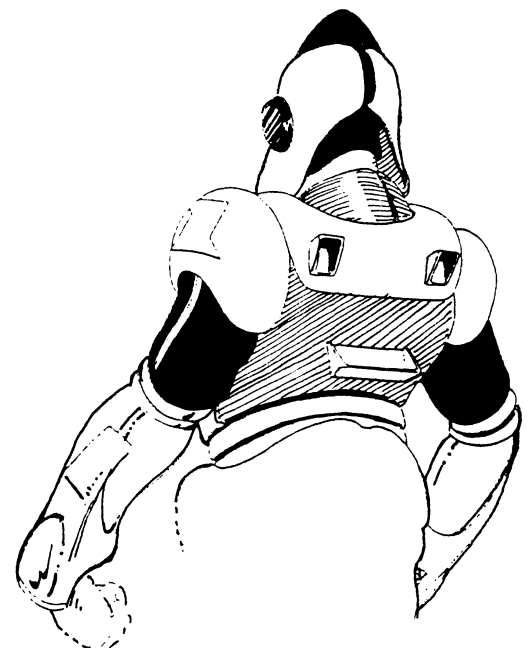

REAR VIEW

SPECIAL TEAMS

While the Armies of the Southern Cross all have areas of expertise and are all competent warriors, the need often arises where the talents of several experts are required. Consequently, *special teams* are created. These teams will combine members of the different Armies, as well as mecha, weapons and equipment.

In a game context, this allows players to select and build the exact type of character desired, without being restricted to one particular Army. The flexibility of a *multi-military O.C.C. special team* means that the adventure possibilities are endless, because this elite team will be sent wherever needed.

Weapon, vehicle, and equipment lists in this book are limited to the items directly found in the Southern Cross T. V. Series. Conventional vehicles, tanks, aircraft, weapons and equipment, are still very common throughout the world, especially in remote regions. I did not wish to waste a dozen or more pages on reprints from **ROBOTECH®** Book One (or the RDF Manual). So I'll simply remind you that conventional and not so conventional items can be found in that book. *See the ROBOTECH®* RPG: Book One, pgs 34-41, for missiles and mecha combat, 69-76 for vehicles, 77-81 for weapons and equipment. Remember, it is only ten to twenty years later. Weapons and technology have changed, but not so greatly that 20 year old items are completely obsolete. Besides, it makes for some interesting mixes, matches and confrontations. So do not hesitate to provide your Southern Cross characters with all sorts of paraphernalia.

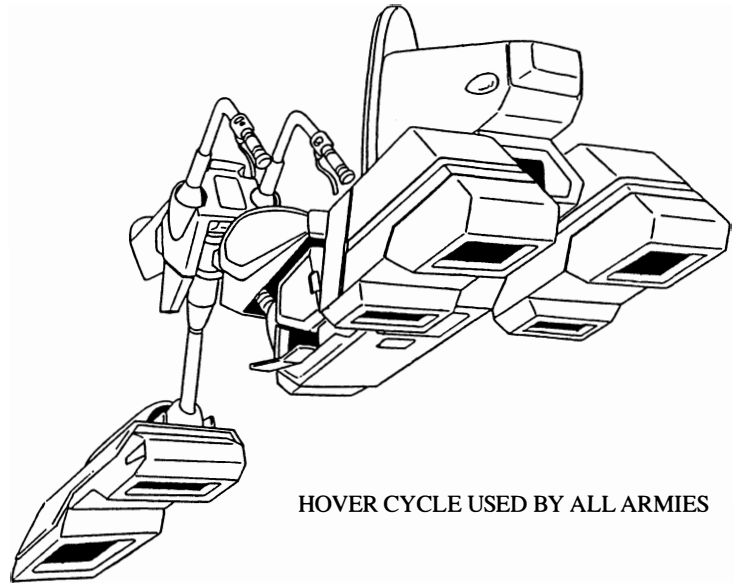

HOVER CYCLE USED BY ALL ARMIES

EXPERIENCE LEVELS PER O.C.C.

G.M.P., R.E.P., H.C.O.S.

Level	1	0000-1925
2	1926-3850	
3	3851-7450	
4	7451-14,900	
5	14,901-21,000	
6	21,001-31,000	
7	31,001-41,600	
8	41,601-53,000	
9	53,001-73,000	
10	73,001-103,500	
11	103,501-139,000	
12	139,001-189,000	
13	189,001-239,000	
14	239,001-289,000	
15	289,001-339,000	

C.D.U., C.D.F.C., Sea Squad

Level	1	0000-1750
2	1751-3500	
3	3501-7000	
4	7001-14,000	
5	14,001-20,000	
6	20,001-29,500	
7	29,501-40,000	
8	40,001-52,000	
9	52,001-72,000	
10	72,001-102,000	
11	102,001-137,000	
12	137,001-187,000	
13	187,001-237,000	
14	237,001-287,000	
15	287,001-327,000	

C.W.O.S., M.o.S., D.S., J.S.

Level	1	0000-1875
2	1876-3750	
3	3751-7250	
4	7251-14,100	
5	14,101-21,200	
6	21,201-31,200	
7	31,201-41,200	
8	41,201-51,200	
9	51,201-71,200	
10	71,201-101,500	
11	101,501-136,500	
12	136,501-186,500	
13	186,501-236,500	
14	236,501-286,500	
15	286,501-326,500	

T.C., T.A.F., C.U.

Level	1	0000-1900
2	1901-3800	
3	3801-7300	
4	7301-14,300	
5	14,301-21,000	
6	21,001-30,000	
7	30,001-40,000	
8	40,001-53,000	
9	53,001-73,000	
10	73,001-103,000	
11	103,001-138,000	
12	138,001-188,000	
13	188,001-238,000	
14	238,001-288,000	
15	288,001-328,000	

A.T.A.C., T.A.S.C.

Level	1	0000-1860
2	1861-3700	
3	3701-7300	
4	7301-14,200	
5	14,201-21,400	
6	21,401-31,600	
7	31,601-41,800	
8	41,801-52,000	
9	52,001-72,000	
10	72,001-102,000	
11	102,001-136,500	
12	136,501-187,000	
13	187,001-238,000	
14	238,001-288,000	
15	288,001-328,000	

ROBOTECH® RPG CHARACTER SHEET

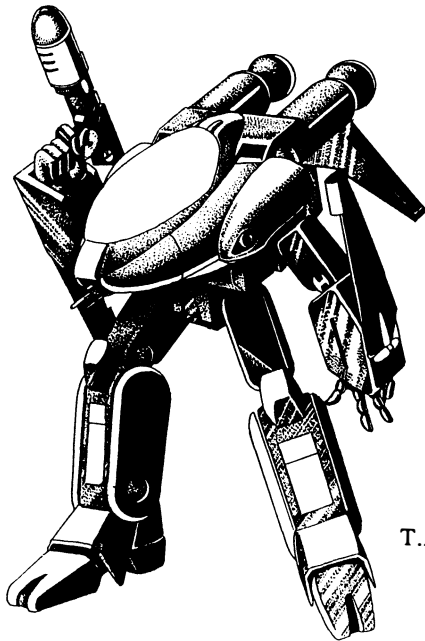

T.A.S.C.

Name: _____
Army O.C.C.: _____
Rank: _____
Alignment: _____
Hit Points: _____ **S.D.C. (Physical):** _____
Body Armor: _____ **M.D.C.:** _____ **Shield:** _____
Experience Level: _____
Savings: _____

I.Q.: _____ **Age:** _____
M.E.: _____ **Sex:** _____
M.A.: _____ **Weight:** _____
P.S.: _____ **Height:** _____
P.P.: _____ **Land of Origin:** _____
P.E.: _____ **Birth Order:** _____
P.B.: _____ **Disposition:** _____
Spd.: _____

O.C.C. Skills:

M.O.S. Skills:

Other Skills:

Weapon Proficiencies:

Combat Skills: Hand to Hand (Normal)
Strike: _____ **Parry:** _____ **Dodge:** _____
Roll: _____ **Damage:** _____ **Kick:** _____
Critical: _____ **Prowl:** _____
Special (Others): _____

Number of Attacks: _____

Type of Mecha: _____

Speed: _____ **Height:** _____

M.D.C.: Main Body: _____ Legs: _____ Arms: _____

Others: _____

Mecha Combat Skills:

Strike: _____ **Parry:** _____ **Dodge:** _____
Roll: _____ **Damage:** _____ **Kick:** _____
Critical: _____ **Body Block:** _____ **Stomp:** _____
Punch: _____ **Special (Others):** _____

Number of Attacks: _____

Missiles: *See Missile Log*

Weapons

Weapon: _____ **Damage:** _____ **Range:** _____
Weapon: _____ **Damage:** _____ **Range:** _____
Weapon: _____ **Damage:** _____ **Range:** _____
Weapon: _____ **Damage:** _____ **Range:** _____
Weapon: _____ **Damage:** _____ **Range:** _____
Weapon: _____ **Damage:** _____ **Range:** _____
Weapon: _____ **Damage:** _____ **Range:** _____

Others: _____

ROBOTECH® RPG CHARACTER SHEET

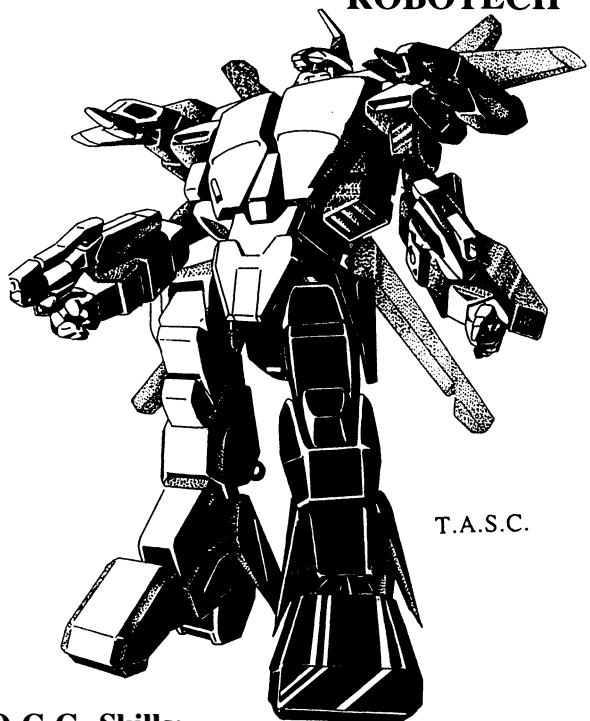

T.A.S.C.

Name: _____
 Army O.C.C.: _____
 Rank: _____
 Alignment: _____
 Hit Points: _____ S.D.C. (Physical): _____
 Body Armor: _____ M.D.C.: _____ Shield: _____
 Experience Level: _____
 Savings: _____

I.Q.: _____ Age: _____
 M.E.: _____ Sex: _____
 M.A.: _____ Weight: _____
 P.S.: _____ Height: _____
 P.P.: _____ Land of Origin: _____
 P.E.: _____ Birth Order: _____
 P.B.: _____ Disposition: _____
 Spd.: _____

Combat Skills: Hand to Hand (Normal)

Strike: _____ Parry: _____ Dodge: _____
 Roll: _____ Damage: _____ Kick: _____
 Critical: _____ Prowl: _____
 Special (Others): _____

Number of Attacks: _____

Type of Mecha: _____

Speed: _____ Height: _____

M.D.C.: Main Body: _____ Legs: _____ Arms: _____

Others: _____

Mecha Combat Skills:

Strike: _____ Parry: _____ Dodge: _____
 Roll: _____ Damage: _____ Kick: _____
 Critical: _____ Body Block: _____ Stomp: _____
 Punch: _____ Special (Others): _____

Number of Attacks: _____

Missiles: *See Missile Log*

Weapons

Weapon: _____ Damage: _____ Range: _____
 Weapon: _____ Damage: _____ Range: _____
 Weapon: _____ Damage: _____ Range: _____
 Weapon: _____ Damage: _____ Range: _____
 Weapon: _____ Damage: _____ Range: _____
 Weapon: _____ Damage: _____ Range: _____
 Others: _____

O.C.C. Skills:

M.O.S. Skills:

Other Skills:

Weapon Proficiencies:

ROBOTECH® RPG CHARACTER SHEET

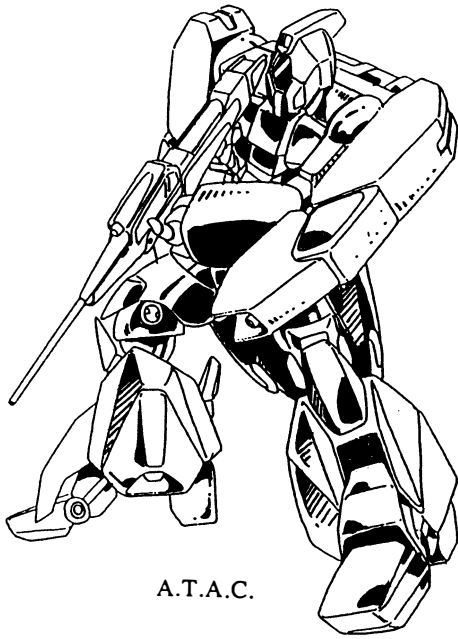

A.T.A.C.

Name: _____
Army O.C.C.: _____
Rank: _____
Alignment: _____
Hit Points: _____ **S.D.C. (Physical):** _____
Body Armor: _____ **M.D.C.:** _____ **Shield:** _____
Experience Level: _____
Savings: _____

I.Q.: _____ **Age:** _____
M.E.: _____ **Sex:** _____
M.A.: _____ **Weight:** _____
P.S.: _____ **Height:** _____
P.P.: _____ **Land of Origin:** _____
P.E.: _____ **Birth Order:** _____
P.B.: _____ **Disposition:** _____
Spd.: _____

Combat Skills: Hand to Hand (Normal)

Strike: _____ **Parry:** _____ **Dodge:** _____
Roll: _____ **Damage:** _____ **Kick:** _____
Critical: _____ **Prowl:** _____
Special (Others): _____

Number of Attacks: _____

Type of Mecha: _____

Speed: _____ **Height:** _____

M.D.C.: Main Body: _____ Legs: _____ Arms: _____

Others: _____

Mecha Combat Skills:

Strike: _____ **Parry:** _____ **Dodge:** _____
Roll: _____ **Damage:** _____ **Kick:** _____
Critical: _____ **Body Block:** _____ **Stomp:** _____
Punch: _____ **Special (Others):** _____

Number of Attacks: _____

Missiles: See Missile Log

Weapons

Weapon: _____ **Damage:** _____ **Range:** _____
Weapon: _____ **Damage:** _____ **Range:** _____
Weapon: _____ **Damage:** _____ **Range:** _____
Weapon: _____ **Damage:** _____ **Range:** _____
Weapon: _____ **Damage:** _____ **Range:** _____
Weapon: _____ **Damage:** _____ **Range:** _____
Weapon: _____ **Damage:** _____ **Range:** _____
Others: _____

O.C.C. Skills:

M.O.S. Skills:

Other Skills:

Weapon Proficiencies:

ROBOTECH® RPG CHARACTER SHEET

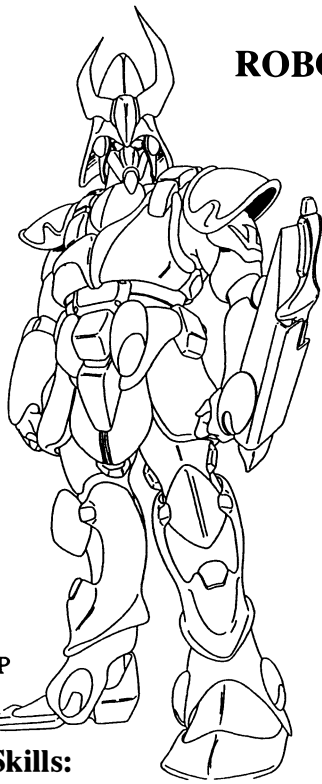

GMP

O.C.C. Skills:

M.O.S. Skills:

Other Skills:

Weapon Proficiencies:

Name: _____
 Army O.C.C.: _____
 Rank: _____
 Alignment: _____
 Hit Points: _____ S.D.C. (Physical): _____
 Body Armor: _____ M.D.C.: _____ Shield: _____
 Experience Level: _____
 Savings: _____

I.Q.: _____ Age: _____
 M.E.: _____ Sex: _____
 M.A.: _____ Weight: _____
 P.S.: _____ Height: _____
 P.P.: _____ Land of Origin: _____
 P.E.: _____ Birth Order: _____
 P.B.: _____ Disposition: _____
 Spd.: _____

Combat Skills: Hand to Hand (Normal)

Strike: _____ Parry: _____ Dodge: _____
 Roll: _____ Damage: _____ Kick: _____
 Critical: _____ Prowl: _____
 Special (Others): _____

Number of Attacks: _____

Type of Battloid:

Speed: _____ Height: _____

M.D.C.: Main Body: _____ Legs: _____ Arms: _____
 Others: _____

Battloid Combat Skills:

Strike: _____ Parry: _____ Dodge: _____
 Roll: _____ Damage: _____ Kick: _____
 Critical: _____ Body Block: _____ Stomp: _____
 Punch: _____ Special (Others): _____

Number of Attacks: _____

Weapons

Weapon: _____ Damage: _____ Range: _____
 Weapon: _____ Damage: _____ Range: _____
 Weapon: _____ Damage: _____ Range: _____
 Others: _____

Equipment:

ROBOTECH® RPG CHARACTER SHEET

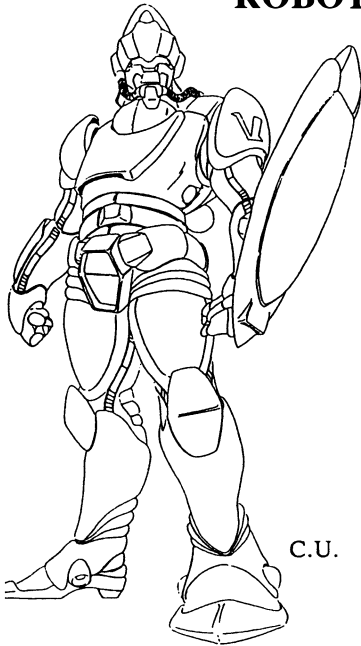

Name: _____
Army O.C.C.: _____
Rank: _____
Alignment: _____
Hit Points: _____ **S.D.C. (Physical):** _____
Body Armor: _____ **M.D.C.:** _____ **Shield:** _____
Experience Level: _____
Savings: _____

I.Q.: _____ **Age:** _____
M.E.: _____ **Sex:** _____
M.A.: _____ **Weight:** _____
P.S.: _____ **Height:** _____
P.P.: _____ **Land of Origin:** _____
P.E.: _____ **Birth Order:** _____
P.B.: _____ **Disposition:** _____
Spd.: _____

O.C.C. Skills:

M.O.S. Skills:

Other Skills:

Weapon Proficiencies:

Combat Skills: Hand to Hand (Normal)

Strike: _____ **Parry:** _____ **Dodge:** _____
Roll: _____ **Damage:** _____ **Kick:** _____
Critical: _____ **Prowl:** _____
Special (Others): _____

Number of Attacks: _____

Type of Battloid:

Speed: _____ **Height:** _____

M.D.C.: Main Body: _____ Legs: _____ Arms: _____

Others: _____

Battloid Combat Skills:

Strike: _____ **Parry:** _____ **Dodge:** _____
Roll: _____ **Damage:** _____ **Kick:** _____
Critical: _____ **Body Block:** _____ **Stomp:** _____
Punch: _____ **Special (Others):** _____

Number of Attacks: _____

Weapons

Weapon: _____ **Damage:** _____ **Range:** _____

Weapon: _____ **Damage:** _____ **Range:** _____

Weapon: _____ **Damage:** _____ **Range:** _____

Others: _____

Equipment:

ROBOTECH® RPG CHARACTER SHEET

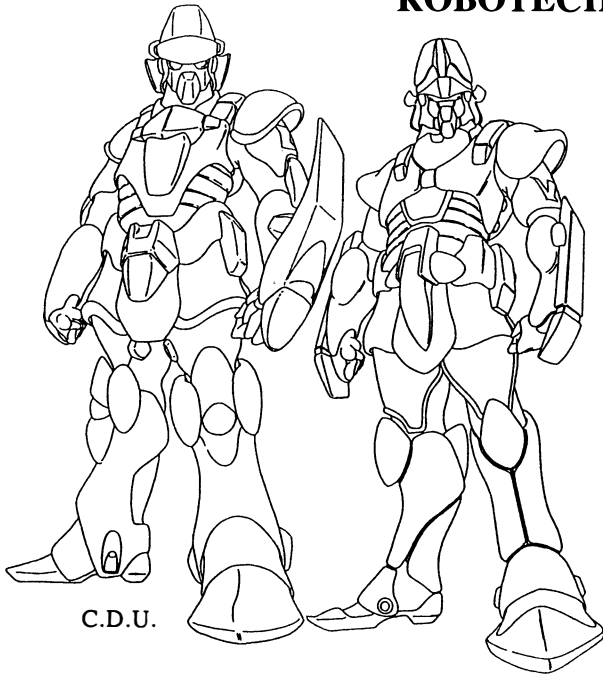

Name: _____
 Army O.C.C.: _____
 Rank: _____
 Alignment: _____
 Hit Points: _____ S.D.C. (Physical): _____
 Body Armor: _____ M.D.C.: _____ Shield: _____
 Experience Level: _____
 Savings: _____

I.Q.: _____ Age: _____
 M.E.: _____ Sex: _____
 M.A.: _____ Weight: _____
 P.S.: _____ Height: _____
 P.P.: _____ Land of Origin: _____
 P.E.: _____ Birth Order: _____
 P.B.: _____ Disposition: _____
 Spd.: _____

O.C.C. Skills:

M.O.S. Skills:

Other Skills:

Weapon Proficiencies:

Combat Skills: Hand to Hand (Normal)

Strike: _____ Parry: _____ Dodge: _____
 Roll: _____ Damage: _____ Kick: _____
 Critical: _____ Prowl: _____
 Special (Others): _____

Number of Attacks: _____

Type of Battloid:

Speed: _____ Height: _____

M.D.C.: Main Body: _____ Legs: _____ Arms: _____

Others: _____

Battloid Combat Skills:

Strike: _____ Parry: _____ Dodge: _____
 Roll: _____ Damage: _____ Kick: _____
 Critical: _____ Body Block: _____ Stomp: _____
 Punch: _____ Special (Others): _____

Number of Attacks: _____

Weapons

Weapon: _____ Damage: _____ Range: _____

Weapon: _____ Damage: _____ Range: _____

Weapon: _____ Damage: _____ Range: _____

Others: _____

Equipment:

ROBOTECH® RPG CHARACTER SHEET

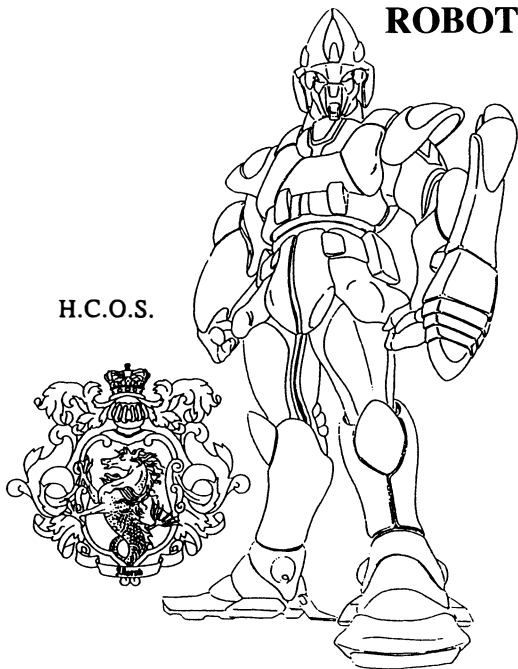

H.C.O.S.

Name: _____
Army O.C.C.: _____
Rank: _____
Alignment: _____
Hit Points: _____ S.D.C. (Physical): _____
Body Armor: _____ M.D.C.: _____ Shield: _____
Experience Level: _____
Savings: _____

I.Q.: _____ Age: _____
M.E.: _____ Sex: _____
M.A.: _____ Weight: _____
P.S.: _____ Height: _____
P.P.: _____ Land of Origin: _____
P.E.: _____ Birth Order: _____
P.B.: _____ Disposition: _____
Spd.: _____

O.C.C. Skills:

M.O.S. Skills:

Other Skills:

Weapon Proficiencies:

Combat Skills: Hand to Hand (Normal)

Strike: _____ Parry: _____ Dodge: _____
Roll: _____ Damage: _____ Kick: _____
Critical: _____ Prowl: _____
Special (Others): _____

Number of Attacks: _____

Type of Battloid:

Speed: _____ Height: _____

M.D.C.: Main Body: _____ Legs: _____ Arms: _____

Others: _____

Battloid Combat Skills:

Strike: _____ Parry: _____ Dodge: _____
Roll: _____ Damage: _____ Kick: _____
Critical: _____ Body Block: _____ Stomp: _____
Punch: _____ Special (Others): _____

Number of Attacks: _____

Weapons

Weapon: _____ Damage: _____ Range: _____
Weapon: _____ Damage: _____ Range: _____
Weapon: _____ Damage: _____ Range: _____
Others: _____

Equipment:

ROBOTECH® RPG CHARACTER SHEET

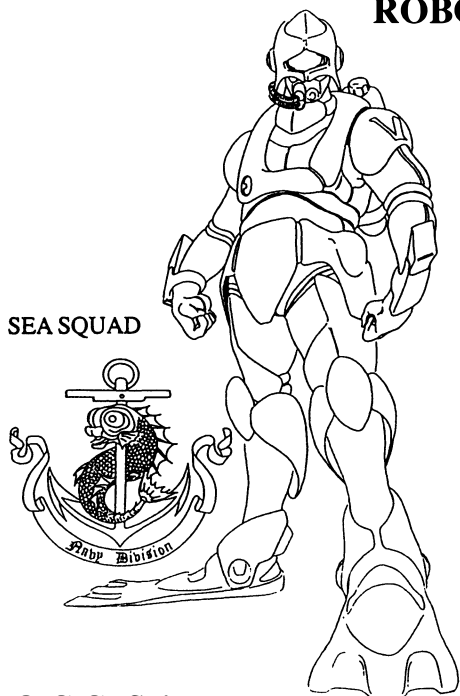

SEA SQUAD

Name: _____
 Army O.C.C.: _____
 Rank: _____
 Alignment: _____
 Hit Points: _____ S.D.C. (Physical): _____
 Body Armor: _____ M.D.C.: _____ Shield: _____
 Experience Level: _____
 Savings: _____

I.Q.: _____ Age: _____
 M.E.: _____ Sex: _____
 M.A.: _____ Weight: _____
 P.S.: _____ Height: _____
 P.P.: _____ Land of Origin: _____
 P.E.: _____ Birth Order: _____
 P.B.: _____ Disposition: _____
 Spd.: _____

O.C.C. Skills:

M.O.S. Skills:

Other Skills:

Weapon Proficiencies:

Combat Skills: Hand to Hand (Normal)

Strike: _____ Parry: _____ Dodge: _____
 Roll: _____ Damage: _____ Kick: _____
 Critical: _____ Prowl: _____
 Special (Others): _____

Number of Attacks: _____

Type of Battloid:

Speed: _____ Height: _____

M.D.C.: Main Body: _____ Legs: _____ Arms: _____

Others: _____

Battloid Combat Skills:

Strike: _____ Parry: _____ Dodge: _____
 Roll: _____ Damage: _____ Kick: _____
 Critical: _____ Body Block: _____ Stomp: _____
 Punch: _____ Special (Others): _____

Number of Attacks: _____

Weapons

Weapon: _____ Damage: _____ Range: _____

Weapon: _____ Damage: _____ Range: _____

Weapon: _____ Damage: _____ Range: _____

Others: _____

Equipment:

ROBOTECH® RPG CHARACTER SHEET



Name: _____
 Army O.C.C.: _____
 Rank: _____
 Alignment: _____
 Hit Points: _____ S.D.C. (Physical): _____
 Body Armor: _____ M.D.C.: _____ Shield: _____
 Experience Level: _____
 Savings: _____

I.Q.: _____ Age: _____
 M.E.: _____ Sex: _____
 M.A.: _____ Weight: _____
 P.S.: _____ Height: _____
 P.P.: _____ Land of Origin: _____
 P.E.: _____ Birth Order: _____
 P.B.: _____ Disposition: _____
 Spd.: _____

O.C.C. Skills:

M.O.S. Skills:

Other Skills:

Weapon Proficiencies:

Combat Skills: Hand to Hand (Normal)

Strike: _____ Parry: _____ Dodge: _____
 Roll: _____ Damage: _____ Kick: _____
 Critical: _____ Prowl: _____
 Special (Others): _____

Number of Attacks: _____

Type of Battloid: _____

Speed: _____ Height: _____

M.D.C.: Main Body: _____ Legs: _____ Arms: _____

Others: _____

Battloid Combat Skills:

Strike: _____ Parry: _____ Dodge: _____
 Roll: _____ Damage: _____ Kick: _____
 Critical: _____ Body Block: _____ Stomp: _____
 Punch: _____ Special (Others): _____

Number of Attacks: _____

Weapons

Weapon: _____ Damage: _____ Range: _____

Weapon: _____ Damage: _____ Range: _____

Weapon: _____ Damage: _____ Range: _____

Others: _____

Equipment: _____

Missile Log

Vehicle Type: _____

Pilot: _____

Missile Type	Total No.	SHORT RANGE MISSILES																							
High Explosive (L)		1	2	3	4	5	6	7	8	9	10	11	12	13	14	15	16	17	18	19	20	21	22	23	24
High Explosive (M)		1	2	3	4	5	6	7	8	9	10	11	12	13	14	15	16	17	18	19	20	21	22	23	24
Fragmentation (L)		1	2	3	4	5	6	7	8	9	10	11	12	13	14	15	16	17	18	19	20	21	22	23	24
Armor Piercing (M)		1	2	3	4	5	6	7	8	9	10	11	12	13	14	15	16	17	18	19	20	21	22	23	24
Plasma/Napalm (M)		1	2	3	4	5	6	7	8	9	10	11	12	13	14	15	16	17	18	19	20	21	22	23	24
Tear Gas		1	2	3	4	5	6	7	8	9	10	11	12	13	14	15	16	17	18	19	20	21	22	23	24
Knock-Out Gas		1	2	3	4	5	6	7	8	9	10	11	12	13	14	15	16	17	18	19	20	21	22	23	24
Smoke		1	2	3	4	5	6	7	8	9	10	11	12	13	14	15	16	17	18	19	20	21	22	23	24
Fire Retardant		1	2	3	4	5	6	7	8	9	10	11	12	13	14	15	16	17	18	19	20	21	22	23	24
Additional Load		1	2	3	4	5	6	7	8	9	10	11	12	13	14	15	16	17	18	19	20	21	22	23	24
Notes																									

Missile Type	Total No.	MEDIUM RANGE MISSILES																							
High Explosive (L)		1	2	3	4	5	6	7	8	9	10	11	12	13	14	15	16	17	18	19	20	21	22	23	24
High Explosive (M)		1	2	3	4	5	6	7	8	9	10	11	12	13	14	15	16	17	18	19	20	21	22	23	24
Heavy Explosive (H)		1	2	3	4	5	6	7	8	9	10	11	12	13	14	15	16	17	18	19	20	21	22	23	24
Fragmentation (M)		1	2	3	4	5	6	7	8	9	10	11	12	13	14	15	16	17	18	19	20	21	22	23	24
Armor Piercing (M)		1	2	3	4	5	6	7	8	9	10	11	12	13	14	15	16	17	18	19	20	21	22	23	24
Plasma/Heat (M)		1	2	3	4	5	6	7	8	9	10	11	12	13	14	15	16	17	18	19	20	21	22	23	24
Multi-Warhead		1	2	3	4	5	6	7	8	9	10	11	12	13	14	15	16	17	18	19	20	21	22	23	24
Smoke		1	2	3	4	5	6	7	8	9	10	11	12	13	14	15	16	17	18	19	20	21	22	23	24
Additional Load		1	2	3	4	5	6	7	8	9	10	11	12	13	14	15	16	17	18	19	20	21	22	23	24
Notes																									

Missile Type	Total No.	LONG RANGE MISSILES																							
High Explosive (M)		1	2	3	4	5	6	7	8	9	10	11	12	13	14	15	16	17	18	19	20	21	22	23	24
High Explosive (H)		1	2	3	4	5	6	7	8	9	10	11	12	13	14	15	16	17	18	19	20	21	22	23	24
Fragmentation (H)		1	2	3	4	5	6	7	8	9	10	11	12	13	14	15	16	17	18	19	20	21	22	23	24
Armor Piercing (M)		1	2	3	4	5	6	7	8	9	10	11	12	13	14	15	16	17	18	19	20	21	22	23	24
Plasma/Heat (M)		1	2	3	4	5	6	7	8	9	10	11	12	13	14	15	16	17	18	19	20	21	22	23	24
Plasma/Heat (H)		1	2	3	4	5	6	7	8	9	10	11	12	13	14	15	16	17	18	19	20	21	22	23	24
Proton Torpedo (H)		1	2	3	4	5	6	7	8	9	10	11	12	13	14	15	16	17	18	19	20	21	22	23	24
Reflex (M)		1	2	3	4	5	6	7	8	9	10	11	12	13	14	15	16	17	18	19	20	21	22	23	24
Reflex (H)		1	2	3	4	5	6	7	8	9	10	11	12	13	14	15	16	17	18	19	20	21	22	23	24
Reflex Multi-Warhead		1	2	3	4	5	6	7	8	9	10	11	12	13	14	15	16	17	18	19	20	21	22	23	24
Additional Load		1	2	3	4	5	6	7	8	9	10	11	12	13	14	15	16	17	18	19	20	21	22	23	24
Notes																									

Other :

EARTH MECHA

VERITECH TRANSFORMABLE MECHA

- **Logan:** Southern Cross.
- **Veritech Attack Copter** (AJACS): Southern Cross.
- **Veritech Hover Tank** (Ground): Southern Cross

BATTLOIDS

NON-TRANSFORMABLE MECHA

- **G.M.P. Multi-Purpose Battloid:** Southern Cross
- **T.C. Recon Battloid:** Southern Cross
- **C.U. Space Battloid:** Southern Cross
- **C.D. Light Battloid:** Southern Cross
- **C.D. Heavy Battloid:** Southern Cross
- **Soldier:** E.B.S.I.S.
- **Juggernaut:** E.B.S.I.S.
- **Recon Destroyer:** E.B.S.I.S.

Note: A handful of the old RDF mecha still remain, scattered around the world.

STANDARD SENSORS AND EQUIPMENT FOR ALL VERITECH (transformable) MECHA

FUEL CAPACITY

The Veritech Fighters are extremely durable. The use of protoculture, micronized reactors, and the science of Robotechnology, gives the Veritech an average, useful life span of 12 years before needing a new energy system. With constant use, the life span is cut by half.

RADAR

Range: 200 miles (321.80km); can track up to 48 targets simultaneously.

MOTION DETECTOR & COLLISION WARNING SYSTEM

Close range: 200ft (61m). Sounds alarm, and red light warns pilot of impending collision and/or immediate target.

RADIO/VIDEO COMMUNICATIONS

Wide band and directional, radio and video telecast capabilities. Range is 600 miles (965.4km) or can be boosted indefinitely via satellite relay.

LASER COMMUNICATIONS

Long-range, directional, communication system. Effective Range: 150,000 miles.

LASER TARGETING SYSTEM

Range: 200 miles

COMBAT COMPUTER

Calculates, stores and transmits data onto the cockpit computer screen or Head Up Display (H.U.D.). Patches in with targeting computer.

EXTERNAL AUDIO PICKUP

Sound amplification listening system. Range: 300ft (91.5m)

LOUDSPEAKER

Loudspeaker system that can amplify the pilot's voice up to 90 decibels.

EXTERNAL VIDEO SURVEILLANCE SYSTEM

A video camera relays images to a cockpit monitor. 360 degree rotation. Range: 300ft (91.5m). Telescopic capabilities: 6× magnification.

TELESCOPIC OPTICAL ENHANCEMENT

Range: 1600ft (488m). Field of vision: 20ft (6.1m)

UTILITY ARMS

This is a set of small, retractable arms housed in the right forearm, to perform delicate work and to effect repairs. Each of the three arms has an A.R. of 6 and 3 M.D.C.

SELF-DESTRUCT

A last ditch effort to prevent capture of the Veritech unit (usually preceded by the pilot's ejecting from the Veritech). Explosive damage is fairly contained — 10ft radius (3m); does 6D6 M.D.

HEAT AND RADIATION SHIELDS

INDEPENDENT OXYGEN AND CIRCULATORY SYSTEM

SENSORS AND EQUIPMENT

STANDARD FOR ALL BATTLOIDS (Non-Transformable Mech)

RADAR

Range: 30 miles (48.2km). Conventional operation.

RADIO/VIDEO COMMUNICATIONS

Wide band, directional radio and video telecast capabilities. Range: 600 miles (965.4km) or can be boosted indefinitely via satellite.

LASER TARGETING SYSTEM

Close Range: Two miles (3.2km)

COMBAT COMPUTER

Calculates, stores and monitors data on the control panel computer screen or head up display.

EXTERNAL AUDIO PICKUP

Sound amplification and sound listening system. Range: 300ft (91.5m).

LOUDSPEAKER

Loudspeaker system that amplifies and projects the pilot's voice up to 90 decibels.

THERMO-IMAGER

A special, optical, *heat* sensory unit that allows the *infrared* radiation of warm objects to be converted into a visible image. Enables the pilot to see in darkness, shadows and through smoke. Range: 1600ft (487m).

NIGHT VISION OPTICS

An image intensifier which is passive, meaning it emits no light of its own, but relies on ambient light which is electronically amplified to give a visible picture. Range: 1600ft (487m).

REINFORCED PILOT'S COMPARTMENT

This is the specially armored and padded pilot compartment designed for maximum protection of the mecha pilot even if the vehicle is totally destroyed.

HEAT AND RADIATION SHIELDS

INDEPENDENT OXYGEN AND CIRCULATORY SYSTEM

FUEL CAPACITY

The use of protoculture, through Robotechnology, gives the Battloids and *all* Mecha a long life span. These giant machines can operate at full capacity for an average life span of 12 years before requiring re-energizing. Constant use will reduce that time by about half.

180 DEGREE ROTATION

All Battloids except the Merchant Republic's, can rotate their torso 180 degrees.

AIR MECHA

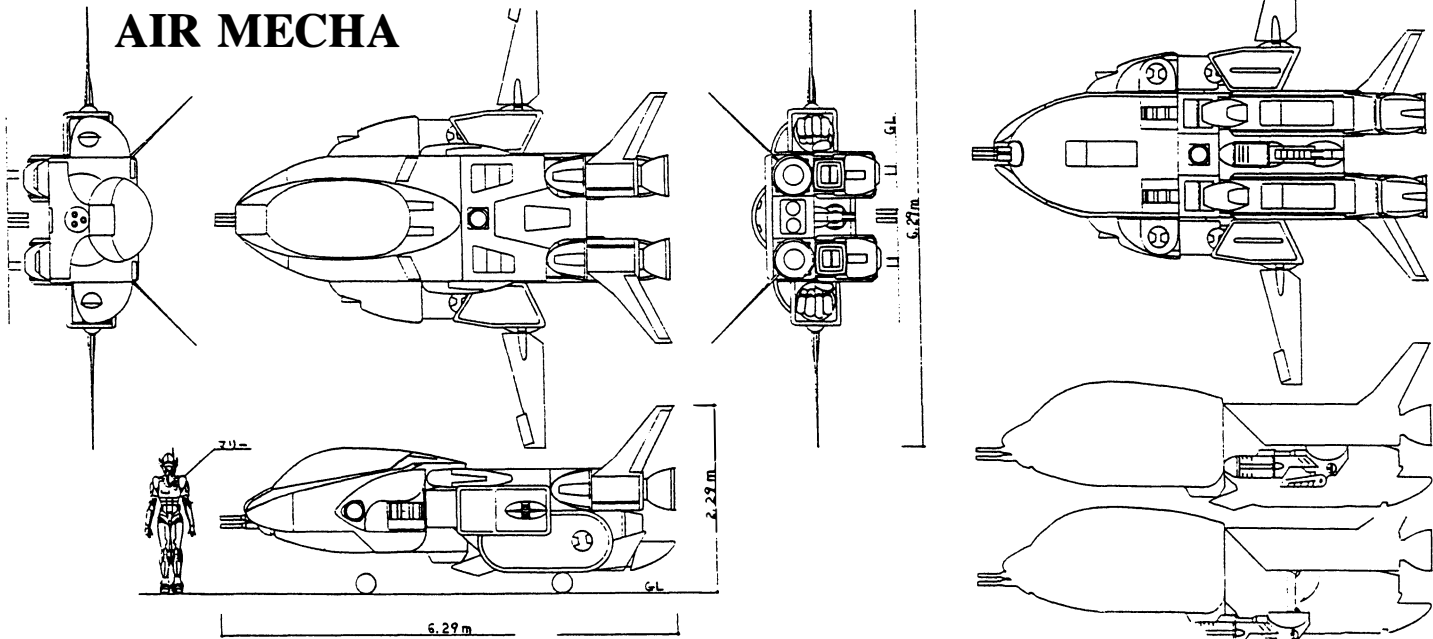

THE LOGAN — 2nd GENERATION VERITECH AIR COMBAT SYSTEM

The “Logan” (Veritech Fighter), like the original VF-Jet series (Macross), is a *transformable*, aircraft. However, there are several distinct differences between the Logan and its predecessor. The Logan is a much smaller, lighter vehicle being less than half the size of the original VF series. The reduced size is to provide greater speed and mobility, although these aspects are actually marginal improvements. The size reduction reflects improvements in the manufacture of Robotech circuitry.

The Logan’s *weapon systems* are quite different from the earlier Veritechs. In jet mode the forward high-powered lasers are supplemented by a rapid-fire cannon built into the nose. The head lasers are completely gone, and the famous GU-11 gun pod is replaced with the more efficient E-20 energy pod, which resembles a giant pistol. The use of missiles is much more limited. Four short range missiles or two medium range missiles *can* be mounted on the wings. However, this is an *optional* mode of attack used *only* when extremely heavy combat is anticipated. The reason for this is simple: The Logan can not change to guardian mode until all missiles have been fired. This severely impairs the versatility of the otherwise transformable mecha unit.

In addition to the size and configuration of the Logan, the single greatest difference from its predecessors is that it has only TWO modes: *Jet and Guardian*. Battloid mode is not a configuration available to the Logan design. However, this does not impair the smaller Veritech’s combat abilities. *First*, the Logan is an assault and defense unit designed specifically for fast, aerial and battlefield combat, and not civil defense or urban combat. *Second*, its small size provides it the versatility to engage in close quarter or urban, ground combat if necessary. The guardian mode is quite satisfactory for ground combat. *Third*, the heavily armored Veritech Hover Tanks serve as the new ground infantry and civil defense units.

A new twist to mecha, as well as battle armor garbed soldiers, is the use of tough, reinforced shields. The complex, metal alloy and laser resistant ceramic coating enables the mecha/soldier to actually parry or block projectiles and energy blasts. The newly developed laser resistant ceramics have also been applied to the mecha itself, making the entire Veritech less vulnerable to laser bombardment. Laser blasts do half damage. Projectile and other energy blasts still do full damage.

It is important to point out that, unlike the original Veritech jet fighters, the Logan is primarily Earthbound and can NOT breach the atmosphere to enter space under its own power. Furthermore, the vehicle does not function particularly well in the vacuum of space. Consequently, the Logan Veritech is rarely used in space. It is the *AJACS Attack Copter* that is specifically designed for space combat.

LOGAN

Vehicle Type: Veritech Fighter (transformable)

Crew: One. A passenger can also fit in the cockpit, but must sit in the pilot’s lap.

M.D.C. by Location:

- Forward Lasers (shoulders) — 20 each
- Nose Tri-Cannon — 40
- Upper Arms — 50 each
- Forearms/Shields (wings) — 300 each
- Hands — 30 each
- Legs — 100 each
- Main Engine Thrusters (2) — 100 each
- Wings (2) — 300 each
- Tail Fins (2) — 20 each
- Retractable Utility Arm — 3
- E-20 Gun Pod — 80
- Reinforced Pilot’s Compartment — 150
- *Main Body — 150

*Depleting M.D.C. of main body shuts the unit completely down.

Speed: Hover (stationary) 3 to 300 feet (.9 to 91.5m) above the ground, 3082mph (Mach 4.6) with a 60 mile service ceiling in **Jet Fighter Mode**. 1340mph/Mach 2 (2156kmph) and as slow as a complete hover in **Guardian mode**. *Running in Guardian mode* is a maximum of 40mph (64kmph). **Note:** Not as suitable for space flight or operations. Speed in jet mode is a little slower; Mach 4 maximum in space. **Height:** 7ft 5in (2.29m) in jet mode; 12ft (3.6m) in Guardian mode.

Width: 20ft 6in (6.29m) from wing tip to wing tip.

Length: 20ft 6in (6.29m)

Weight: 6 tons

Main Engine: FH-3001 Fusion Turbine

Range: Effectively unlimited. The reactor-style power source provides enough energy to operate for about four years of constant use. The average life span of the power system is 8 years before requiring replenishment of proticulture.

THE LOGAN

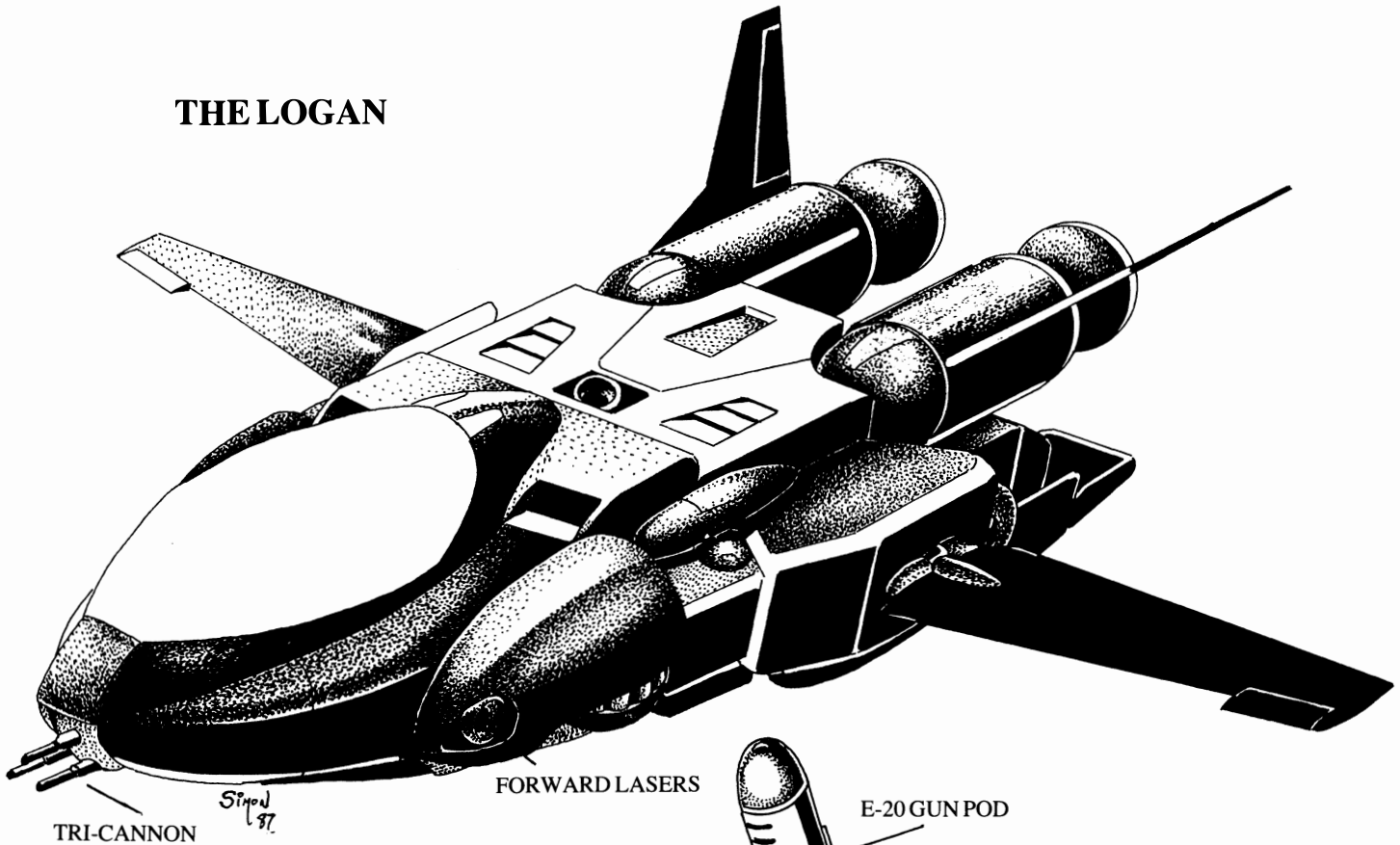

TRI-CANNON

Simpson 87

FORWARD LASERS

E-20 GUN POD

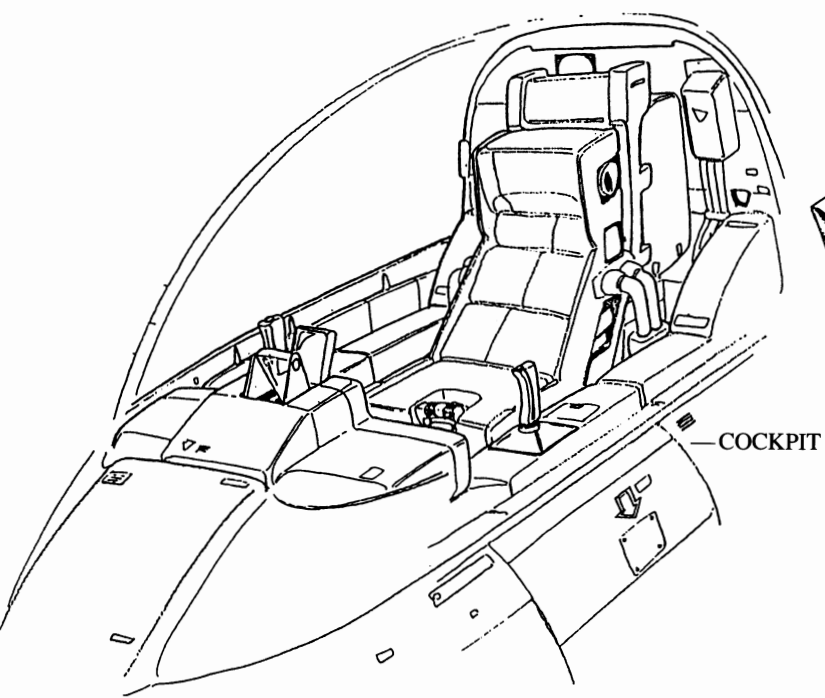

COCKPIT

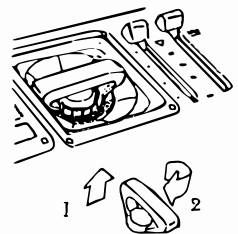

LEVER FOR TRANSITION INTO GUARDIAN MODE

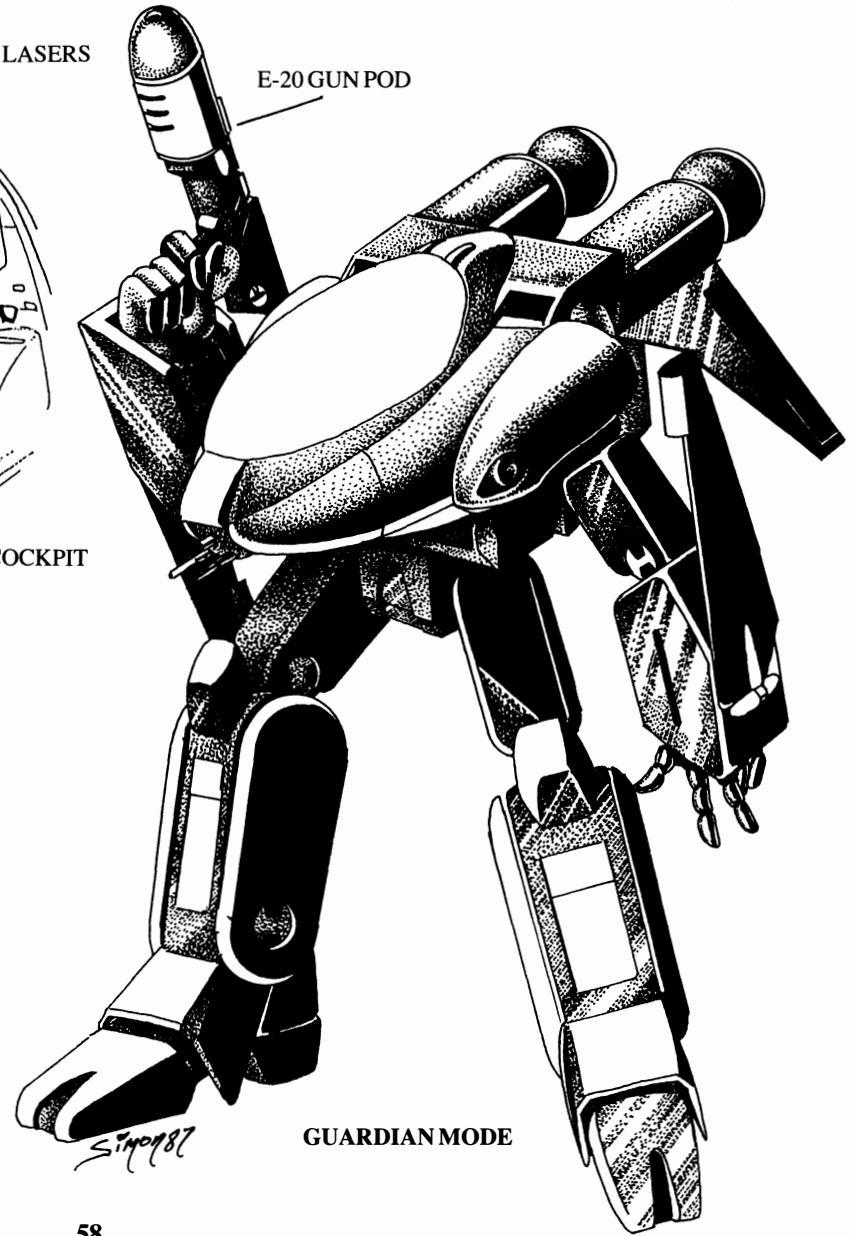

GUARDIAN MODE

Weapon Systems

1. Forward High-Powered Lasers: A pair of lasers are built into what might be viewed as the shoulders of the Veritech Fighter for dog fights and assault. They can be fired in both jet and guardian modes. Angle of fire is fixed to fire forward only.

Primary Purpose: Assault

Secondary Purpose: Anti-Missile

Range: 4000ft (1200m)

Mega-Damage: 6D6 M.D. per twin blast. If one laser is destroyed, reduce damage by half.

Rate of Fire: Equal to the pilot's combined number of hand to hand attacks per melee.

Payload: Unlimited

2. Rapid-Fire Tri-Cannon: This is the main weapon of the Logan, inflicting massive damage. It is limited to a fixed forward mounting in the nose of the mecha, which restricts firing to straight ahead. To fire up, side to side, or other angles, the entire torso must be moved. However, the fluid, easy movement attained from the symbiotic link between pilot and machine makes this a simple maneuver.

Primary Purpose: Assault

Secondary Purpose: Anti-Vehicle

Range: 8000ft (2400m)

Mega-Damage: 1D6 × 10 per each blast.

Rate of Fire: The number of blasts is equal to the pilot's combined number of hand to hand attacks.

Payload: Unlimited

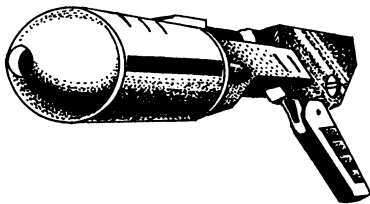

3. E-20 Energy Gun Pod. This Veritech handgun is a standard issue armament for all Logan Veritechs. It is a smaller, improved version of the GU-11 gun pod.

Primary Purpose: Assault/Defense

Range: 4000ft (1200m)

Mega-Damage: 1D4 × 10 per blast

Rate of Fire: The number of blasts is equal to the pilot's combined number of hand to hand attacks.

Payload: Unlimited

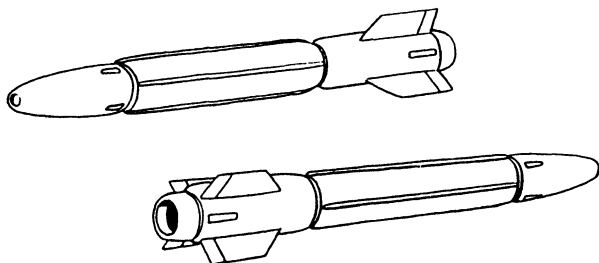

4. Optional Missiles. The Logan Veritech can carry and fire a limited number of short or medium range missiles. However, this is only done when a first strike, long-range assault is anticipated. Otherwise, the addition of missiles prohibits the transformable nature of the vehicle, and therefore its versatility and success as a combat mecha.

The base commander must authorize all use of missiles.

Primary Purpose: Assault

Range: Short or medium range missiles only.

Mega-Damage: Varies with specific missile types.

Rate of Fire: 2, 3 or entire payload.

Payload: A total of four short range or a total of two medium range missiles.

5. Optional Hand to Hand: Punch does 1D4 M.D., body block — 1D6 M.D., and kick does 1D4 M.D.

WEAPON COMBAT SUMMARY

Attacks Per Melee: Equal to the combined hand to hand attacks of the pilot. Usually 4 attacks at first level.

High-Powered Lasers: 6D6 M.D.; Range: 4000ft (1200m)

Tri-Cannon: 1D6 × 10 M.D.; Range: 8000ft (2400m)

E-20 Gun Pod: 1D4 × 10 M.D.; Range: 400ft (1200m)

Alternate Mode of Attack:

2 to 4 missiles.

Hand to Hand Combat.

THE AJACS VERITECH ATTACK COPTER

The Veritech Attack Copter is a versatile mecha designed specifically for space combat, but is also capable of land, or air combat. The basic frame and structure is taken directly from the Veritech Hover Tank. The difference arises from the AJAC's modifications to enable the basic hovercraft to be space-worthy.

As a deep space combat machine the AJACS has no peers. It is twice as agile in space as on land or in an atmosphere. In its element (space) the AJACS can easily outmaneuver the standard space combat fighters, attaining a space speed of Mach 5 and displaying superior maneuverability made possible by the thruster/movement jets built into its feet, arms and helicopter blades. Add its weapon systems of lasers and missiles and some believe it is even superior to the old VF series Veritech Fighters.

Weapon systems include a high-powered laser built into the helicopter's nose (head, when in battloid mode), a heavy-duty pulse laser in the arm, and a complement of missiles. The lasers are perfect in an atmosphereless environment, while the medium range missiles give it even greater range and destructive potential.

In an atmosphere the mecha's jet speed is reduced to Mach 2.5, and a comparatively sluggish 240mph (386kmph) traveling as a helicopter. Yet it is the helicopter aspect that provides the AJACS its true versatility. As a helicopter it has vertical take-off and landing (VTOL) capabilities, can stop and hover in mid-air at any altitude, fly low to the ground and even maneuver in an urban environment. Maximum altitude with jets engaged is a service ceiling of 60,000 feet.

Although the AJACS Attack Copter is a Veritech mecha, it has only *two modes* of transformation: Helicopter, with jet speed and flight capabilities, and Battloid, with space mobility. As previously stated, it is specifically designed as a space combat vehicle and functions equally well in both modes. Unlike its atmosphere-bound cousins, the AJACS does not have any special arm shield. Thus, it can not parry or block energy or projectile attack without blowing its arm to ribbons.

AJACS VERITECH ATTACK COPTER

Vehicle Type: Veritech Attack Helicopter (transformable)

Crew: One; plus one passenger can also fit in the pilot's compartment.

M.D.C. by Location:

Head — 60

Arms — 100 each

Hands — 40 each

Arm Turbo Thrusters (2) — 50 each

Legs — 200 each

Tail Section — 125

Tail Fins (3) — 20 each

Helicopter Blades (4) — 40 each

Blades Rotor (1) — 70

Wings (2) — 125 each

Jet Thrusters (2) — 100 each

Missile Pods (2) — 100 each

Forward, Head Laser — 50
Arm Pulse Laser — 100
Reinforced Pilot's Compartment — 150
*Main Body — 250

*Depleting M. D. C. of the main body shuts the unit completely down.

Note: Destruction of the tail fins, helicopter blades, rotor, tail section, and wings, will not impair *flight in space*. However, destruction of the tail section will prevent the mecha from transforming into battloid mode. Loss of a wing also means the loss of the missile rack attached to that wing.

Loss of one or both wings in the atmosphere will prevent jet speed, but helicopter flight is unimpaired. Loss of the tail section will severely hamper flight, making jet speed impossible; helicopter speed is reduced by half, can NOT transform and is minus -4 to strike and dodge.

Speed: Hover as helicopter (stationary) with no height restriction, maximum *helicopter speed* is 240mph (386kmph), maximum *jet speed* is 1675mph/Mach 2.5 (2695kmph), but doubled in space to Mach 5. *Running in Battloid mode* is 35mph (56kmph). *Speed in space as a battloid* is a maximum of 50mph (80kmph). **Note:** Designed for space combat the AJACS attack chopper has directional thrusters in its feet, arms and helicopter blades.

Height: 9ft (2.7m) in helicopter mode, 26ft (7.9m) in battloid mode.

Width: 18ft 5in (5.8m) from wing tip to wing tip in both modes; 8ft (2.4m) from shoulder to shoulder.

Length: 25ft (7.6m) in helicopter mode, 7ft (2.1m) in battloid mode.

Weight: 13 tons

Main Engine: FD-1001 Fusion Turbine

Range: Effectively unlimited, with an average life of 8 years.

BATTLROID MODE

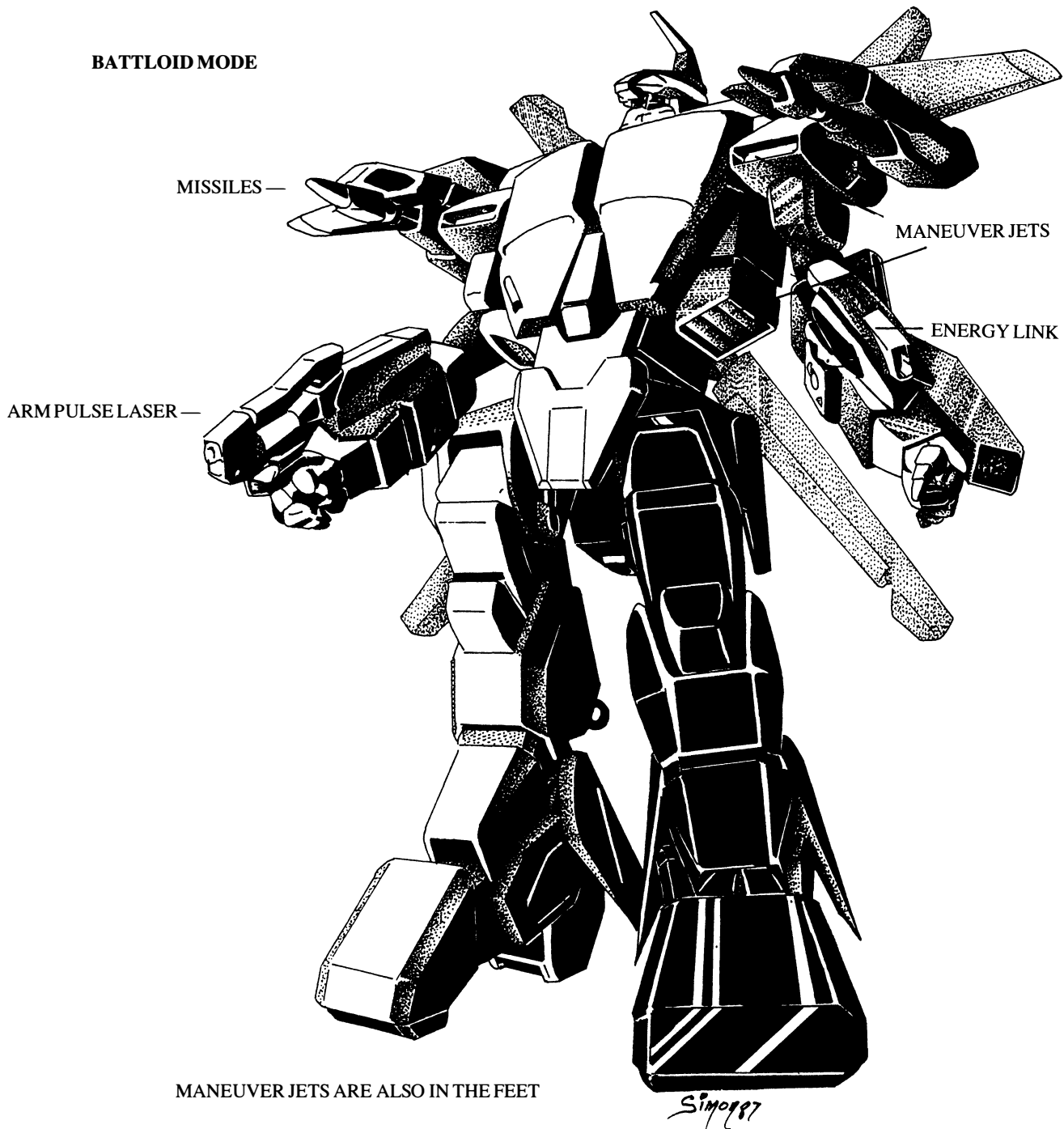

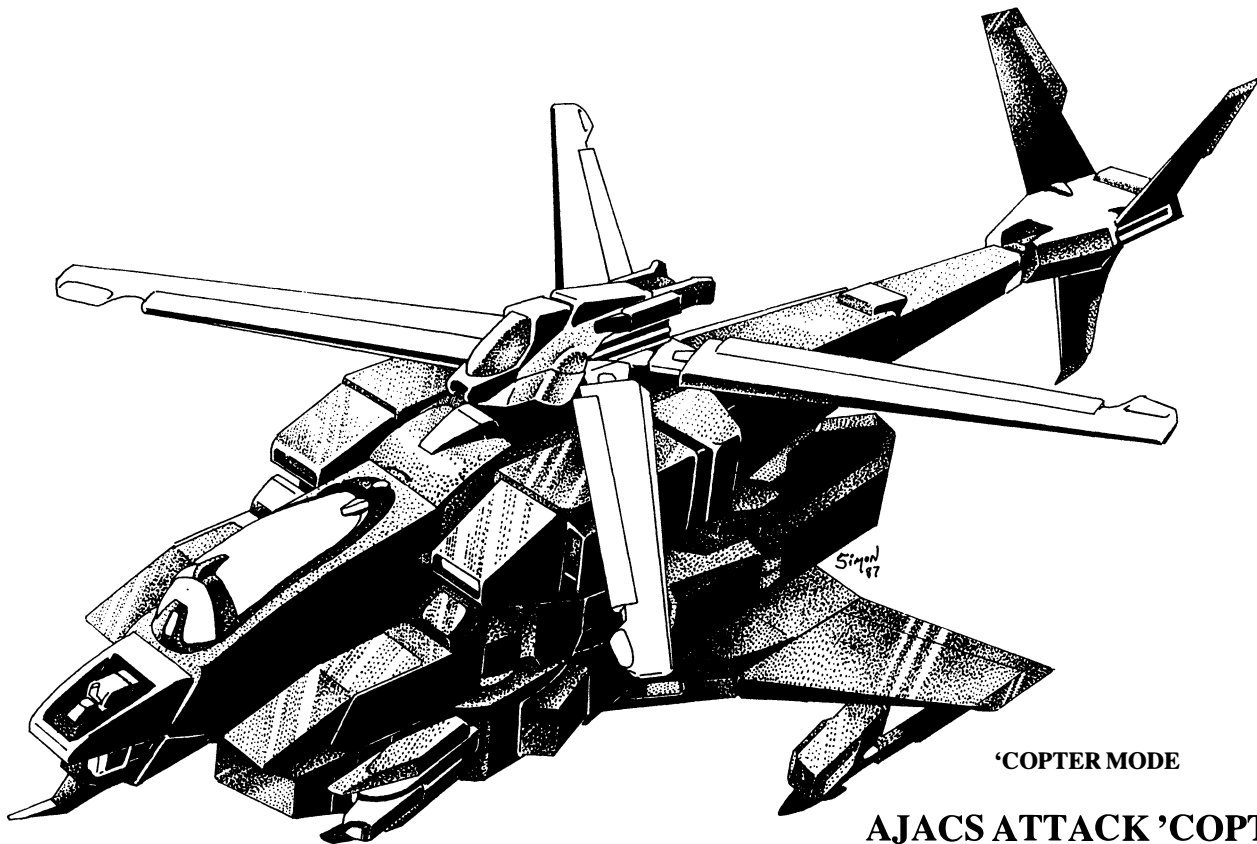

'COPTER MODE

AJACS ATTACK 'COPTER

Weapon Systems

1. **Forward High-Powered Laser:** One high-powered laser is built into the nose of the Veritech attack chopper, and located in the head during battloid mode. In helicopter mode the laser is fixed, shooting straight ahead. As a battloid the head/laser can turn 45 degrees to the right, left, up and down. The laser can fire in both modes.

Primary Purpose: Assault

Secondary Purpose: Anti-Missile

Range: 4000ft (1200m)

Mega-Damage: 3D6 M.D.

Rate of Fire: Equal to the pilot's combined number of hand to hand attacks.

Payload: Unlimited

2. **Arm Pulse Laser:** Mounted on the right arm is a large, heavy-duty, pulse laser that appears to be a hand held gun pod (but it *is* actually attached to the arm). If necessary, the laser can be detached and mounted on the left arm. This weapon is exclusive to the AJACS Veritech.

Primary Purpose: Assault

Secondary Purpose: Anti-Vehicle

Range: 8000ft (2400m)

Mega-Damage: 1D4 × 10

Rate of Fire: Equal to the pilot's combined hand to hand attacks.

Payload: Unlimited.

3. **Missile Pods:** Mounted on each wing is a missile pod which contains a battery of medium range missiles. Both missile launcher pods are armored to avoid detonation by enemy attacks.

Primary Purpose: Assault/Defense

Missile Type: Any medium range, guided missiles. Usually fragmentation, high explosive (heavy), plasma and/or armor piercing.

Mega-Damage: Varies with missile type.

Rate of Fire: In volleys of two or four. Remember, each volley, even if four missiles are fired, counts as one attack. The number of missile volleys which can be fired per melee is equal to the pilot's combined hand to hand attacks.

Range: Varies with missile type.

Payload: Each of the two missile pods contain 8 missiles, for a total of 16.

4. **Optional Use of the EU-11 Gun Pod.** This is the identical weapon used by the Veritech Tank. While it is not standard issue, the weapon can be easily used if available. *See Veritech Hover Tank for exact statistics.*
5. **Optional use of the E-20 Gun Pod.** This is not a standard issue weapon, but can be used if needed and if available.
6. **Optional Hand to Hand Combat.** Rather than fire any weapons, the Veritech can engage in hand to hand combat. Restrained punch does 1D4 M.D., full punch — 2D4 M.D., power punch — 3D4 M.D., kick 1D6 M.D., stomp — 1D4 M.D.

WEAPON COMBAT SUMMARY

Attacks Per Melee: Equal to the combined hand to hand attacks of the pilot. Usually 5 attacks at first level.

High-Powered Laser: 3D6 M.D.; Range: 4000ft (1200m)

Arm Pulse Laser: 1D4 × 10 M.D.; Range: 8000ft (2400m)

Missile Launcher Pods: Damage and range vary with missile type.

Payload: 16.

Alternate Modes of Attack:

Use of EU-11 Gun Pod: Hand held; see Veritech Tank.

Use of E-20 gun Pod: Hand held; see Logan.

GROUND MECHA

THE VERITECH

HOVER TANK (VHT)

It is generally agreed that the most powerful and toughest of the new Mecha is the Hover Tank. Like all the Mecha of the Southern Cross, the Veritech Tank is much smaller than the Destroids and Veritech Fighters that came before it. However, only a fool would believe that this mighty little mecha was any less powerful. The super alloys which compose its armor and its protoculture based technology makes it as tough as the old Excaliber, and its transformable capabilities make it superior as a ground based assault unit.

The Veritech Tank's reduced size and transformable configurations give it a versatility of movement and range of capabilities unequalled by any of the earlier mecha, with the possible exception of the VF series of Veritech Fighters. The Veritech Hover Tank is designed specifically for ground/urban combat and civil defense. This means it can easily maneuver among the concrete canyons of a city. Unlike the larger mecha, the VHT is more in scale with a city and can engage in combat without fear of tumbling buildings down with every wrong move. Likewise, the Hover Tank can engage in high speed pursuits, fit down any street (even alleyways) and modify its size, available weapon systems and mode of transportation by transforming into a different configuration.

The three modes of the Veritech Hover Tank are *Transport, Tank and Battloid*. In the *transport mode* the mecha is an armored transport vehicle capable of speeds of up to 100mph (160.90kmph), and easily traverses the most rocky and rugged terrain. In this mode the mecha hovers on powerful jets of air, 3 to 10 feet (.9m to 3m) above the ground. The EU-11 gun pod rests in a special housing in the center, front, of the tank. In this mode it serves as the mecha's only armament.

A quick transition into *tank mode* (also referred to as "guardian" mode) sends the mecha into its most lethal configuration. The main cannon is now exposed and ready to unleash its devastating ion blasts. Its secondary, triple-barrelled, auto cannon is also ready to wreak havoc. The EU-11 gun pod is tucked away and can not be fired in this mode. The main disadvantage of the tank mode is that all movement is incredibly restricted. Maximum speed is a dreadful 8mph (12.8kmph).

Battloid mode provides all the already known advantages of the humanoid form; all terrain capabilities, climbing, running, grasping, leaping, kicks, etc. A new twist to combat is the feasibility of an ancient defensive weapon, the shield. Like the knights of old, the Veritech Hover Tank, and Logan Veritech Fighter, are equipped with especially tough, some say nearly impervious, shields built onto the arms. In the case of the Logan it is the wings; on the VHT it is the weapon housings of the main cannon and the tri-cannon that serve as shields. In battloid mode the two huge, housing units appear to be attached at the shoulder and can be manipulated by arm movement. These so-called shields are so tough that they can block/parry armor piercing shells and energy beams (including particle beams). A successful parry means that damage is sustained only by the shielding that was used to parry the attack. Each arm shield has twice as much M.D.C. as the main body.

The still mysterious symbiotic relationship between man and machine, infused by protoculture, enables the massive mecha to react with the same quickness as a top athlete. The disadvantages of the battloid mode are reduced speed and the immediate availability of only one weapon, the EU-11 gun pod. The main cannon can be extended out of its arm shield housing to fire, but it is the ONLY, one, attack possible that melee. No other attacks or aggressive actions are possible regardless of how many attacks per melee might normally be available. Parries and dodges are still possible.

A new development in armor is a laser resistant ceramic which is

used to coat *all* new mecha, as well as the many suits of battle armor. What this means is that laser weapons do only half damage. This does NOT include any other energy attacks such as particle beams or ion blasts. Nor does it help against explosives.

VERITECH HOVER TANK

a.k.a. Spartas ATAC-01-SCA

Vehicle Type: Veritech Tank (transformable).

Crew: One. Two passengers can be placed in the back seat.

M.D.C. by Location:

Head — 60
Headlights (2 on top) — 5 each
Hands — 50 each
Arms — 150 each
Arm Shield (2) — 600 each
Legs — 200 each
Retractable Hover Jets (2) — 55 each
*Rear, Lower Hover Jets (2) — 50 each
Retractable Utility Arms (3) — 3 each
Main Cannon — 120
Tri-Auto Cannon — 75
EU-11 Gun Pod (rifle) — 100
Reinforced Pilot's Compartment — 200
** Main Body — 300

*Note that the rear, lower hover jets are located on the rear underbelly or bottom in transport mode, rear underside in tank mode, and lower back when in battloid mode. *The front, retractable hover jets* are targets only in the transport mode. Loss of both prevents movement in that mode.

**If the M.D.C. of the main body is depleted, the unit shuts completely down.

Speed: Hover in transport and tank/guardian modes (stationary) — 3 to 10 feet above the ground (.9m to 3m). Maximum speed in transport mode is 100mph (160.90kmph), maximum speed in tank/guardian mode is 8mph (12.8kmph), and running in battloid mode is 35mph (56kmph). *Special maneuvers:* The VHT can leap or propel itself straight up into the air — 80ft (24.4m) in ALL modes. In battloid mode the mecha can leap up to 120ft (36.6m) high with the assistance of the booster jets built into its feet and 80ft length (24.4m). In space the jets in the feet help movement.

Height: 20ft 4in (6.2m) Battloid, 14ft 8in (4.5m) Tank/Guardian mode and 7ft 4in (2.25m) Transport mode.

Width: 14ft 4in (4.4m) Battloid, 7ft 4in (2.25m) Tank/Guardian mode and 9ft (2.7m) in Transport mode.

Length: 6ft 6in (2.0m) Battloid, 25ft 4in (7.75m) in Tank/Guardian mode and 19ft 7in in Transport mode.

Weight: 16.4 tons

Main Engine: MT 842 Fusion Reactor.

Weapon Systems

1. Main Cannon: A rapid-fire ion cannon is located in the left, weapon housing shield/arm. Although it can not rotate or move right to left, it can move up and down in a 45 degree angle. The main cannon is only exposed in the Tank/Guardian mode, but can also be used (one attack per melee) in battloid mode if extended from the weapon housing of the left arm.

Primary Purpose: Assault/Defense

Secondary Purpose: Anti-Aircraft

Range: 8000ft (2400m)

Mega-Damage: 3D4 × 10 per each blast.

Rate of Fire: In *Tank/Guardian mode* it can fire as many times equal to the pilot's combined number of hand to hand attacks per melee. In *Battloid mode* the use of the big gun preempts all other attacks rendering

**VHT VERITECH
HOVER TANK**

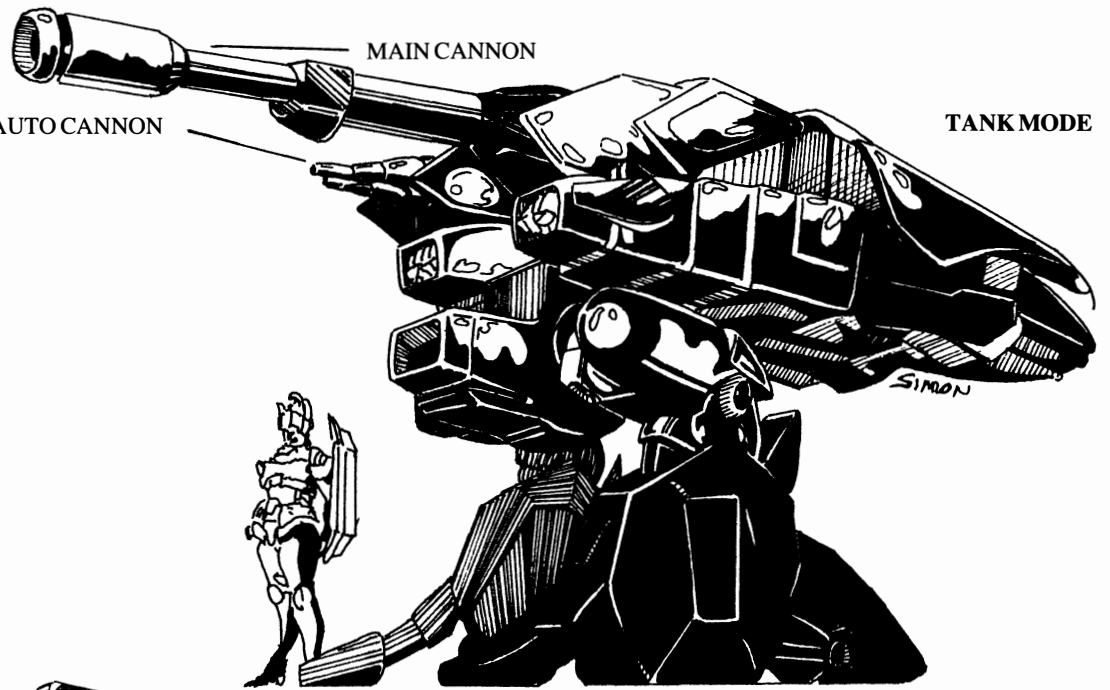

MAIN CANNON

TRIPLE-BARRELED AUTO CANNON

TANK MODE

BATTLOID MODE



WEAPON SLEEVES/SHIELDS

TRANSPORT MODE

EU-11 GUN POD IN HOUSING

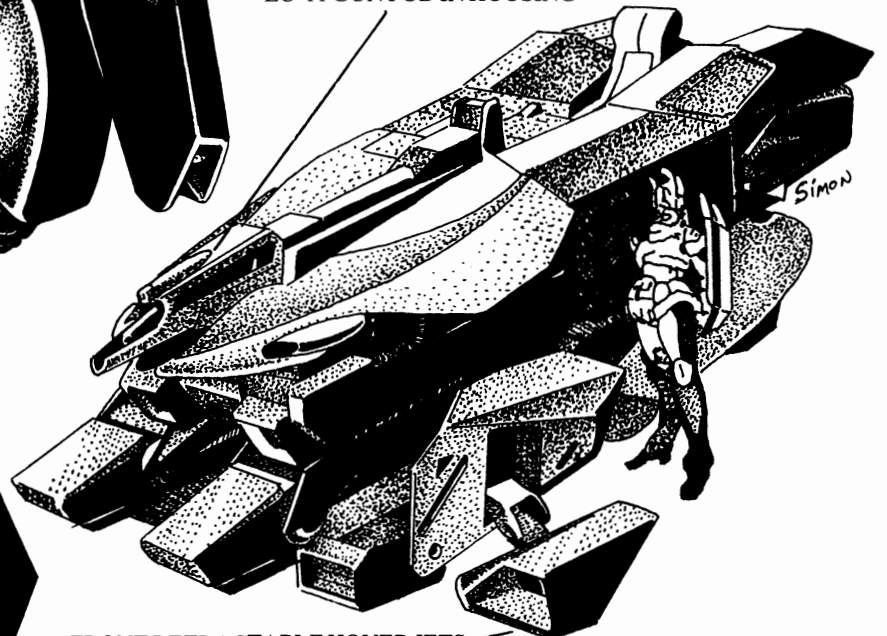

FRONT RETRACTABLE HOVER JETS



EU-11 GUN POD

the mecha with only ONE attack per melee regardless of the pilot's total number of attacks per melee.

Payload: *Conditionally Unlimited.* The main gun can shoot up to 30 times within one hour or less (actually within minutes, if necessary). Unfortunately, the energy drain is incredible. Thus, if all 30 shots are fired in an hour or less the cannon will temporarily be drained and can not fire again for at least one hour. The ion generator recharges at a rate of 10 blasts per one hour (up to a total of 30 blasts).

2. Triple-Barrelled Auto Cannon: This is the secondary weapon of the VHT in Tank/Guardian mode, firing 32mm rounds. It can fire only in this mode. Its fixed forward mounting limits the direction of the auto cannon to straight ahead. However, the upper torso of the Hover Tank can move in a 45 degree angle to the left and right, as well as up and down. Also, a quick flick of the booster jets in the feet and the VHT can turn in any direction, including completely around.

Primary Purpose: Assault/Defense.

Secondary Purpose: Antipersonnel

Range: 4000ft (1200m)

Mega-Damage: 6D6 M.D. per burst.

Rate of Fire: Equal to the pilot's combined number of hand to hand attacks per melee.

Payload: 40 bursts can be fired before reloading is required. Reloading is automatic, but takes one full melee. All VHT auto cannons have enough ammo for 5 reloadings (that's 200 bursts).

3. The EU-11 Gun Pod: This is standard issue for the Veritech Hover Tank. It is a rapid-fire energy rifle similar in function to the old GU-11 gun pods. In transport mode the weapon is mounted, fixed forward, in the front center of the tank. In Battloid mode it is a hand held rifle. It can not fire in Tank/Guardian mode.

Primary Purpose: Assault/Defense

Range: 6000ft (1800m)

Mega-Damage: 1D4 × 10

Rate of Fire: Equal to the pilot's combined number of hand to hand attacks per melee.

Payload: Effectively unlimited.

4. Optional use of the E-20 Gun Pod. This is not a standard issue weapon, but can be used if needed and if available. *See Logan Veritech for details.*

5. Optional Hand to Hand Combat: Rather than fire any weapons, the VHT can engage in hand to hand combat. Restrained punch does 1D4 M.D., full punch — 2D6 M.D., power punch — 2D6 + 6 M.D., body block — 2D6 M.D., kick — 1D6 M.D., leap kick — 2D6 M.D. and stomp — 1D4 M.D.

Remember, as with ALL mecha, the weapons or type of attack can be used in any combination as long as they do not exceed the total combined number of the pilot's hand to hand attacks per melee.

WEAPONS COMBAT SUMMARY

Attacks Per Melee: Equal to the combined hand to hand skills of the pilot. Usually 5 attacks at first level

Main Cannon: 3D4 × 10 M.D.; Range: 8000ft (2400m).

Tri-Auto Cannon: 6D6 M.D.; Range: 6000ft (1800m).

EU-11 Gun Pod: 1D4 × 10 M.D.; Range: 4000ft (1200m).

Alternate Modes of Attack:

Use of the E-20 Gun Pod: Hand held; see Logan.

Hand to Hand Combat: Punch, kick, body block.

NON-TRANSFORMABLE BATTLOIDS

Giant mecha of humanoid shape have always proven to be extremely versatile and excellent *all terrain vehicles* (ATV). The ability to grasp, carry, climb, run, leap, kick, grapple and so on, effectively creates a giant, powerful extension of the human body. The use of protoculture so binds the human pilot and his machine host body that each complements the other perfectly, both functioning as one. Movement is almost as fluid and easy as the unhampered human body. Consequently, it is little wonder that the Southern Cross Defense Corps has constructed a handful of these battloids to assist them in their efforts.

Generally speaking, the purpose of these mechanical gargantuas are *rescue, recovery, and reconnaissance.* They can dig through debris to retrieve survivors or objects better than any conventional construction or earth moving machines. The mecha can pick up and cradle a small child in its hands or crush an armored vehicle. Its array of sensors can identify the living or mechanical with equal ease. The armored goliaths can scale a mountain or skyscraper, maneuver around buildings and tight areas or punch, their way through that same building.

Like the Zentraedi Female Power Armor and most mecha, the pilot sits in the chest to operate the battloid. Surrounding him in the cockpit is an array of viewing screens, sensor displays and controls. Most battloids require one pilot and can accommodate one or two passengers.

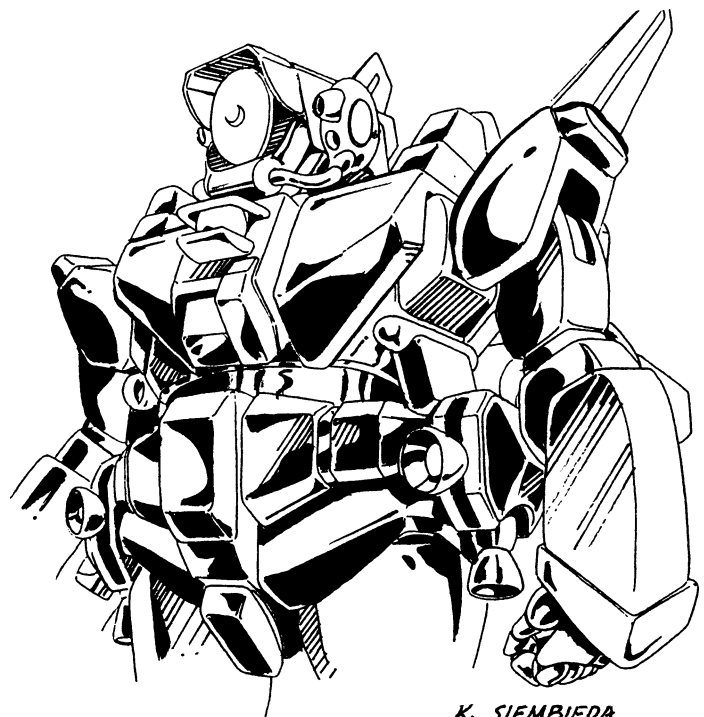

THE G.M.P. MULTI-PURPOSE BATTLOID

The most powerful and versatile of the non-transformable battloid mecha is the *Global Military Police (G.M.P.) Multi-Purpose Battloid.* This impressive mecha is designed to function in all environments including outer space, and underwater, and even possesses limited flight. Directional jets are built into both hips, feet and shoulder blades for maximum mobility in space and underwater. The quick addition of a detachable jet pack now gives it superior mobility in those environments, as well as limited flight capabilities. With the jet pack the G.M.P. Battloid can hover 1 to 300 feet (.3 to 91.5m) high, or perform jet

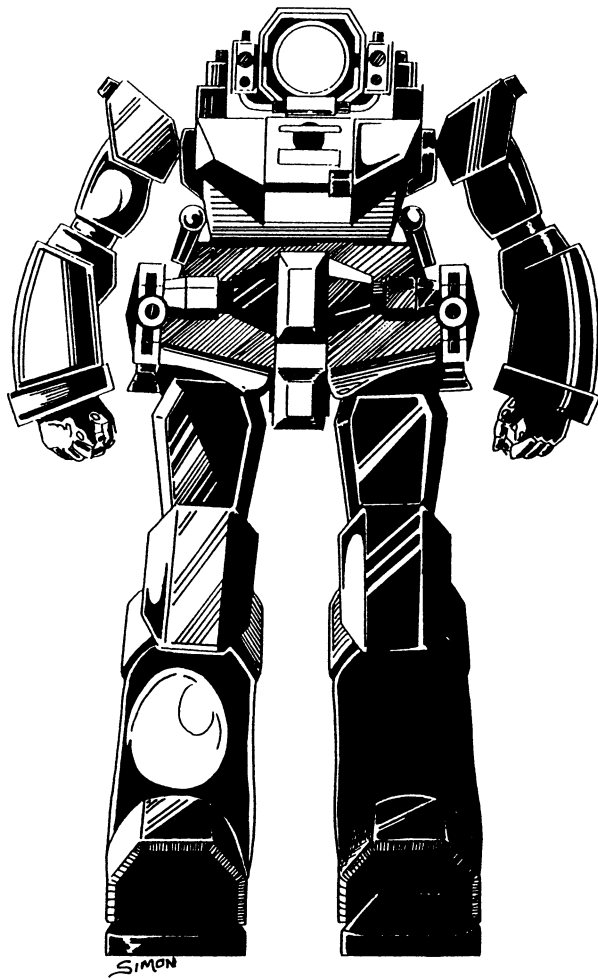

boosted leaps that will send it hurling 300 feet (91.5m) upward or lengthwise. Brief periods of flight, lasting 10 minutes (maximum altitude, 300ft), is also possible. After 10 minutes of continuous flight the jet pack must be allowed to cool down for at least one half hour or it will burn out completely (within 2D4 minutes).

The G.M.P. Battloid is the most heavily armored and, although it does not carry a shield, its forearms are specially armored so that they function just like the more obvious shield attachments. This means that energy beams and projectiles can be parried/blocked with the forearm. Other features include a small spotlight in its chest, and small, twin lasers on the sides of the head. Most sensors are also located in the head. Colors are dark, blue-black shoulders, chest, waist and legs; with light blue arms, head and highlights.

G.M.P. Multi-Purpose Battloid

Vehicle Type: Non-Transformable Combat Battloid

Crew: One, and can accommodate one passenger.

M.D.C. by Location:

- Head — 60
- Head Lasers (2) — 12 each
- Chest Spotlight — 10
- Hands — 30 each
- Upper Arms — 100 each
- Forearm/Shields — 300 each
- Legs — 200 each
- Hip Maneuvering Jets — 30 each nozzle (6)
- Jet Pack — 100
- Jet Pack Main Thrusters (2) — 40 each
- Jet Pack Booster Jets (2) — 20 each
- Reinforced Pilot Compartment — 100
- *Main Body — 200
- EU-11 or E-20 — 100

*If the M.D.C. of the main body is depleted, the mecha shuts completely down.

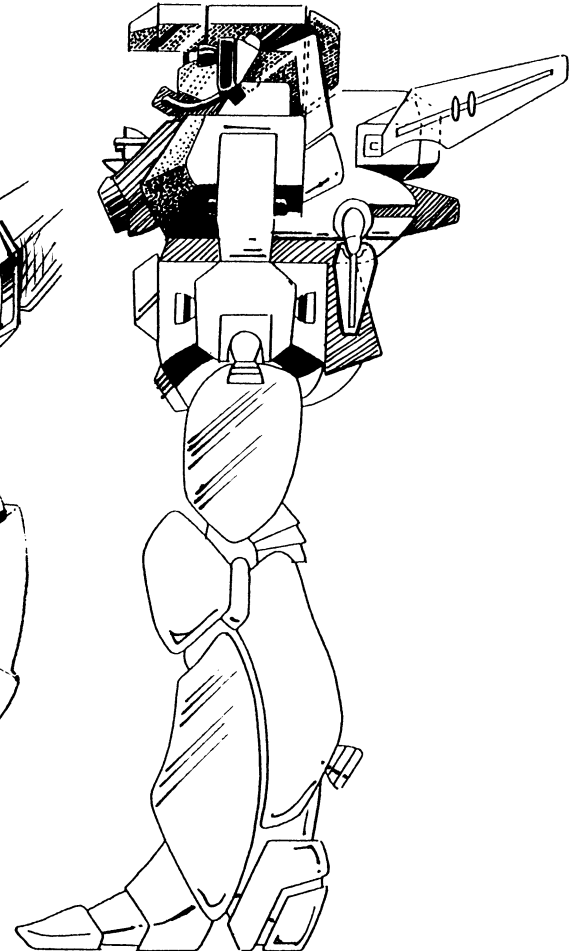
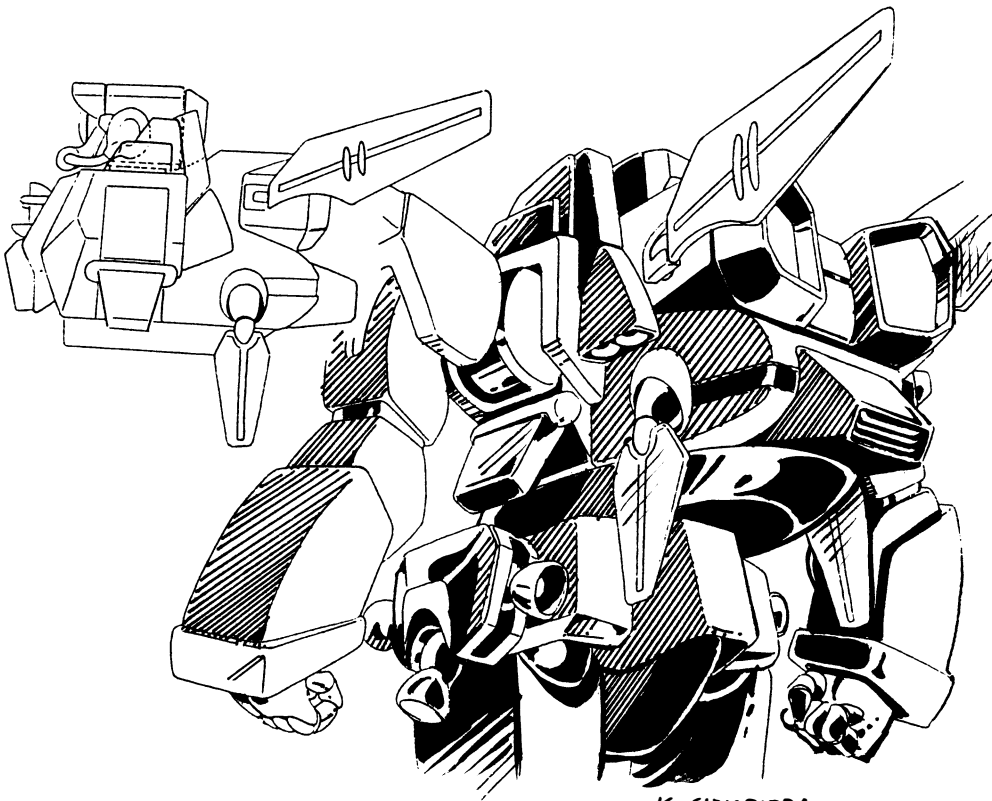

G.M.P. BATTLOID

K. SIEMBIEDA

Speed: Running without jet pack — 45mph (72kmph), wearing heavy jet pack — 35mph (56kmph). Flight with jet pack in an atmosphere — 50mph (80kmph); flight in space with jet pack — 200mph (321kmph). *Special maneuvers:* Leap without jet pack — 20ft (6.1m) high or long; leap with jet boost from the jet pack — up to 300ft (91.5m) high or across. Hover (stationary) with jet pack — 1 to 300 feet (.3 to 91.5m) above the ground. *Speed underwater* with jet pack is — 50mph (80kmph), without — about 5mph (8kmph).

Height: 20ft (6.1m)

Width: 10ft (3m)

Length: 6ft (1.8m)

Weight: 14 tons without jet pack, 16.5 tons with jet pack.

Main Engine: MT 844 Fusion Reactor

Weapon Systems

1. **Twin Head Lasers** are mounted on both sides of the head. The lasers can rotate up and down at a 90 degree angle. They can be fired individually or simultaneously (counts as one attack, even though both are fired.)

Primary Purpose: Assault/Defense

Range: 4000ft (1200m)

Mega-Damage: 2D6 for one laser or 4D6 if both are fired simultaneously.

Rate of Fire: Equal to the pilot's combined number of hand to hand attacks per melee.

Payload: Unlimited

2. **An EU-11 Gun Pod** (rifle) is usually standard issue. This is the identical weapon carried by the Veritech Hover Tank.

Primary Purpose: Assault/Defense

Range: 6000ft (1800m)

Mega-Damage: 1D4 × 10

Rate of Fire: Equal to the pilot's total hand to hand per melee.

Payload: Unlimited.

3. **Optional Use of the E-20** (pistol) gun pod. This is not standard issue, but can be used if needed and available. *See the Logan Veritech Fighter for details.*

4. **Optional Hand to Hand Combat:** Rather than fire any weapons the battloid can engage in hand to hand combat. Restrained punch does 1D4 M.D., full punch — 2D4 M.D., body block — 2D4 M.D., kick — 1D6 M.D., leap kick — 2D6 M.D. and stomp — 1D4 M.D.

WEAPON COMBAT SUMMARY

Attacks Per Melee: Equal to the combined number of hand to hand attacks of the pilot. Usually 4 attacks at first level.

Twin Head Lasers: 2D6 or 4D6 M.D.; Range: 4000ft (1200m)

EU-11 Gun Pod: 1D4 × 10 M.D.; Range: 6000ft (1800m).

Alternate Modes of Attack:

Use of the E-20 Gun Pod: Hand held; see Logan.

Hand to Hand Combat: Punch, kick, body block.

T.C. RECON BATTLOID

The *Tactical Corps* uses a battloid for reconnaissance, as well as rescue and recovery. As a special recon mecha it is equipped with enhanced optics, sensors and built-in video camera recording system. The T.C. Recon Battloid is less powerfully built than the G.M.P. Battloid, but it is a formidable fighting machine often used for scouting and investigation within enemy lines. It is also a troop support mecha, shielding and assisting soldiers in the field.

Twin heavy lasers are mounted on both sides of its head. The face plate is divided into a high intensity spotlight (top) and special optical/camera system (bottom). The unit is also fitted with a sophisticated radar system which enables it to identify and track 100 individual targets, simultaneously, at a distance of 200 miles (321kmph). A booster jet built into the back enables the battloid to perform jet boosted leaps

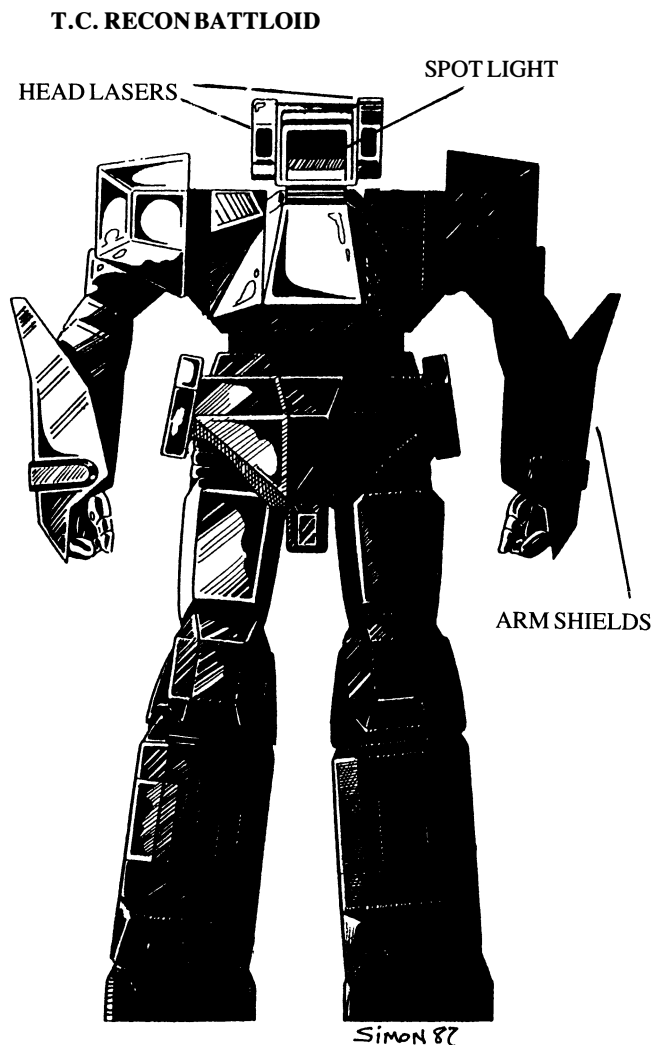

of up to 200 feet (61m) high and 100 feet across. It also enables it to function underwater and in space, if necessary.

TACTICAL CORPS RECONNAISSANCE BATTLOID

Vehicle Type: Non-Transformable Combat Battloid.

Crew: One, and can accommodate one additional passenger.

M.D.C. by Location:

Head — 60

Head Lasers (2) — 20 each

Head Spotlight — 10

Head Camera — 20

Hands — 20 each

Upper Arms — 70 each

Forearms/Shields (2) — 300 each

Legs — 150 each

Back Thruster — 70

Reinforced Pilot's Compartment — 100

*Main Body — 150

EU-11 or E-20 — 100

*If the M.D.C. of the main body is depleted, the mecha shuts completely down.

Speed: Running — 90mph (144kmph); travel underwater with booster thruster — 30mph (48kmph), in space with thruster — 40mph (64kmph). *Special maneuvers:* Leap without thruster — 20ft (6.1m), with booster thruster — up to 200ft (61m). The thruster is not powerful enough to provide flight or hovering.

Height: 18ft (5.5m)

Width: 8ft 6in (2.6m)

Length: 5ft 7in (1.7m)

Weight: 8 tons

Main Engine: MT 844 Fusion Reactor

Weapon Systems

1. **Heavy Duty Head Lasers** are mounted on both sides of the head.

The lasers can rotate up and down at a 90 degree angle. They can be fired individually or simultaneously (counts as one attack, even though both are fired).

Primary Purpose: Assault/Defense

Range: 4000ft (1200m)

Mega-Damage: 3D6 for one laser, or 6D6 if both are fired simultaneously (counts as one attack).

Rate of Fire: Equal to the pilot's combined number of hand to hand attacks per melee.

Payload: Unlimited

2. **An EU-11 Gun Pod** (rifle) is usually standard issue. This is the identical weapon carried by the Veritech Hover Tank.

Primary Purpose: Assault/Defense

Range: 6000ft (1800m)

Mega-Damage: 1D4 × 10 M.D.

Rate of Fire: Equal to the pilot's total hand to hand.

Payload: Unlimited.

3. **Optional use of the E-20**(pistol) gun pod. This is not standard issue, but can be used if needed and available. *See the Logan Veritech Fighter for details.*

4. **Optional Hand to Hand Combat:** Rather than fire any weapons the battloid can engage in hand to hand combat. Restrained punch does 1D4 M.D., full punch — 2D4 M.D., body block — 2D4 M.D., kick — 1D4 M.D., leap kick — 2D6 M.D. and stomp — 1D4 M.D.

SPECIAL EQUIPMENT

1. **Advanced Radar and Sensory System** built into the head of the recon battloid. Radar range is 200 miles (321km) and can identify and track 100 targets simultaneously.

2. **Infrared and Visible Light Searchlight:** Located in the head. Range: 400ft (122m).

3. **Optics:** Infrared and ultraviolet optical/video scan system, telescopic lens, video recorder, passive nightvision, heat detector. Range: 600ft (180m).

WEAPON COMBAT SUMMARY

Attacks Per Melee: Equal to the combined number of hand to hand attacks of the pilot. Usually 4 attacks at first level.

Heavy Duty Head Lasers: 3D6 or 6D6 M.D.; Range: 4000ft (1200m).

EU-11 Gun Pod: 1D4 × 10 M.D.; Range: 6000ft (1800m).

Alternate Modes of Attack:

Use of the E-20 gun pod: hand held; see Logan.

Hand to Hand Combat: Punch, kick, body block.

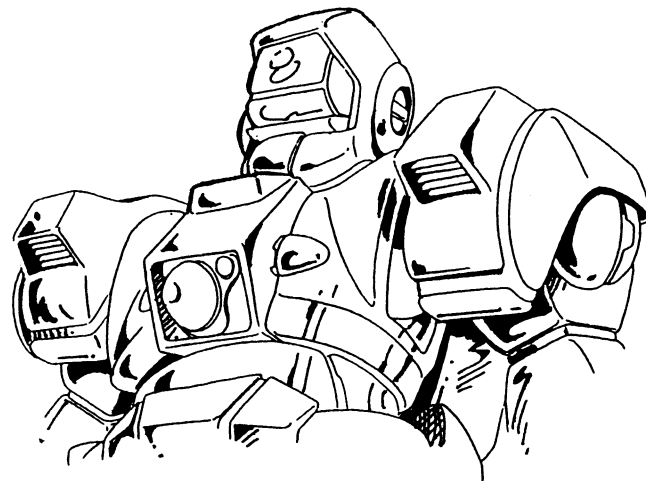

C.U. SPACE BATTLOID

The Cosmic Unit of the Southern Cross has a battloid designed specifically to assist them in space. A six thruster jet pack is attached to provide maximum movement and mobility. Directional thruster jets in the feet, forearms, front shoulders, and buttock area, gives the massive machine an agility in space one does not expect from something that appears so cumbersome. The propulsion system enables the mecha to function underwater as well.

A unique feature is the towline system built into its chest. The large, circular appendage fires a towline that can be used to haul in wreckage, other battloids or samples. The towline can be fitted with a powerful electromagnetic head, or spike, or grappling hook-type head. The maximum weight which can hauled by one C.U. Battloid is 30 tons.

COSMIC UNIT SPACE BATTLOID

Vehicle Type: Non-Transformable Combat Battloid.

Crew: One, and can accommodate one additional passenger.

M.D.C. by Location:

Head — 50

Head Spotlight — 10

Hands — 30 each

Upper Arms — 100 each

Forearms/Shields (2) — 300 each

Legs — 150 each

Shoulder Thrusters (2) — 25 each

Jet Pack — 100

Jet Pack Thrusters (6) — 20 each

Chest Towline Housing — 70

Reinforced Pilot's Compartment — 100

*Main Body — 150

EU-11 or E-20 — 100

Electromagnetic Pads (feet) (2) — 15 each

*If the M.D.C. of the Main Body is depleted, the mecha shuts completely down.

Speed: Running — 35mph (56kmph); travel underwater without jet pack — 8mph (12.8kmph), with jet pack — 50mph (80kmph). *In outer space* without jet pack — 10mph (16kmph), with jet pack — 200mph (321kmph). *Special maneuvers:* Thruster enhanced leap in atmosphere — 30ft (9.1m) high and long; in space can jet to speeds of 200mph. *Bonuses in space* for mobility: +1 to parry, dodge and roll.

Height: 20ft (6.1m)

Width: 10ft (3m)

Length: 8ft 5in (2.5m)

Weight: 13 tons without jet pack, 15.6 tons with jet pack.

Main Engine: MT 844 Fusion Reactor

Weapon Systems

There are no weapons built into this mecha. Thus, hand held weapons are the only combat mechanisms available.

1. An E-20 (pistol) is usually standard issue because it is a one-handed gun pod, leaving the other hand free for other functions. This is the identical weapon carried by the Logan Veritech Fighter.

Primary Purpose: Assault/Defense

Range: 4000ft (1200m)

Mega-Damage: 1D4 × 10 M.D.

Rate of Fire: Equal to the pilot's total hand to hand.

Payload: Unlimited

2. **Optional use of the EU-11 Gun Pod** (rifle). This is not standard issue, but can be used if needed and available. See the Veritech Hover Tank for details.

C.U. SPACE BATTLOID

MANEUVERING JETS

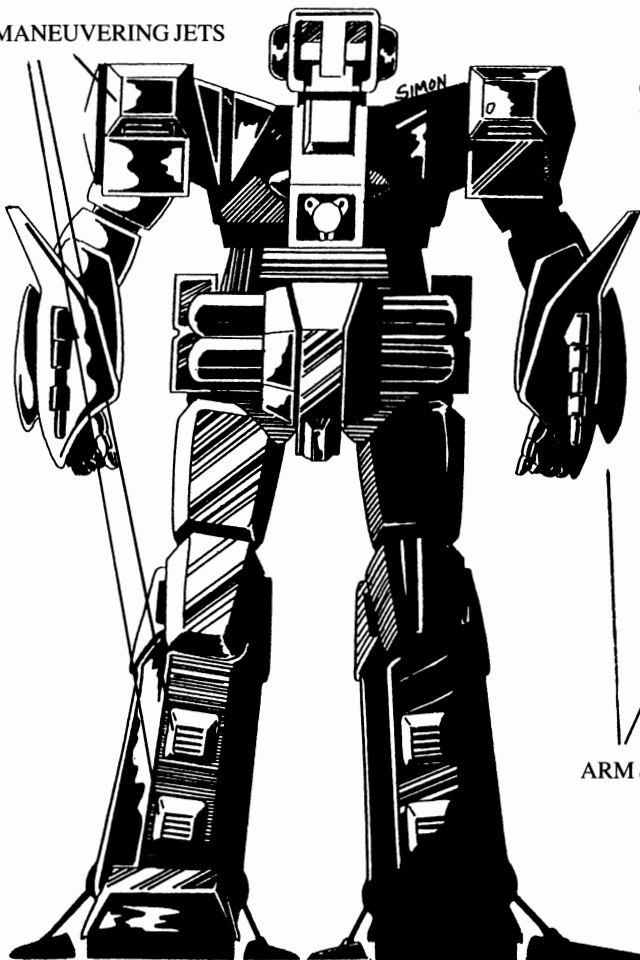

SPECIAL EQUIPMENT

1. **Towline:** Maximum weight capacity: 30 tons.
2. **Electromagnetic Foot Pads** used to adhere and/or walk on metal surfaces.
3. **Can Carry/Lift** 10 tons and twice as much in zero gravity.

WEAPON COMBAT SUMMARY

Attacks Per Melee: Equal to the combined number of hand to hand attacks of the pilot. Usually 4 attacks per melee at first level.

E-20 Gun Pod: 1D4 × 10; Range: 4000ft (1200m).

Alternate Modes of Attack:

Use of the EU-11 Gun Pod: hand held; see Logan.

Hand to Hand Combat: Punch, kick, body block.

— SIDE VIEW OF HEAD



JET PACK THRUSTERS

ARM SHIELDS

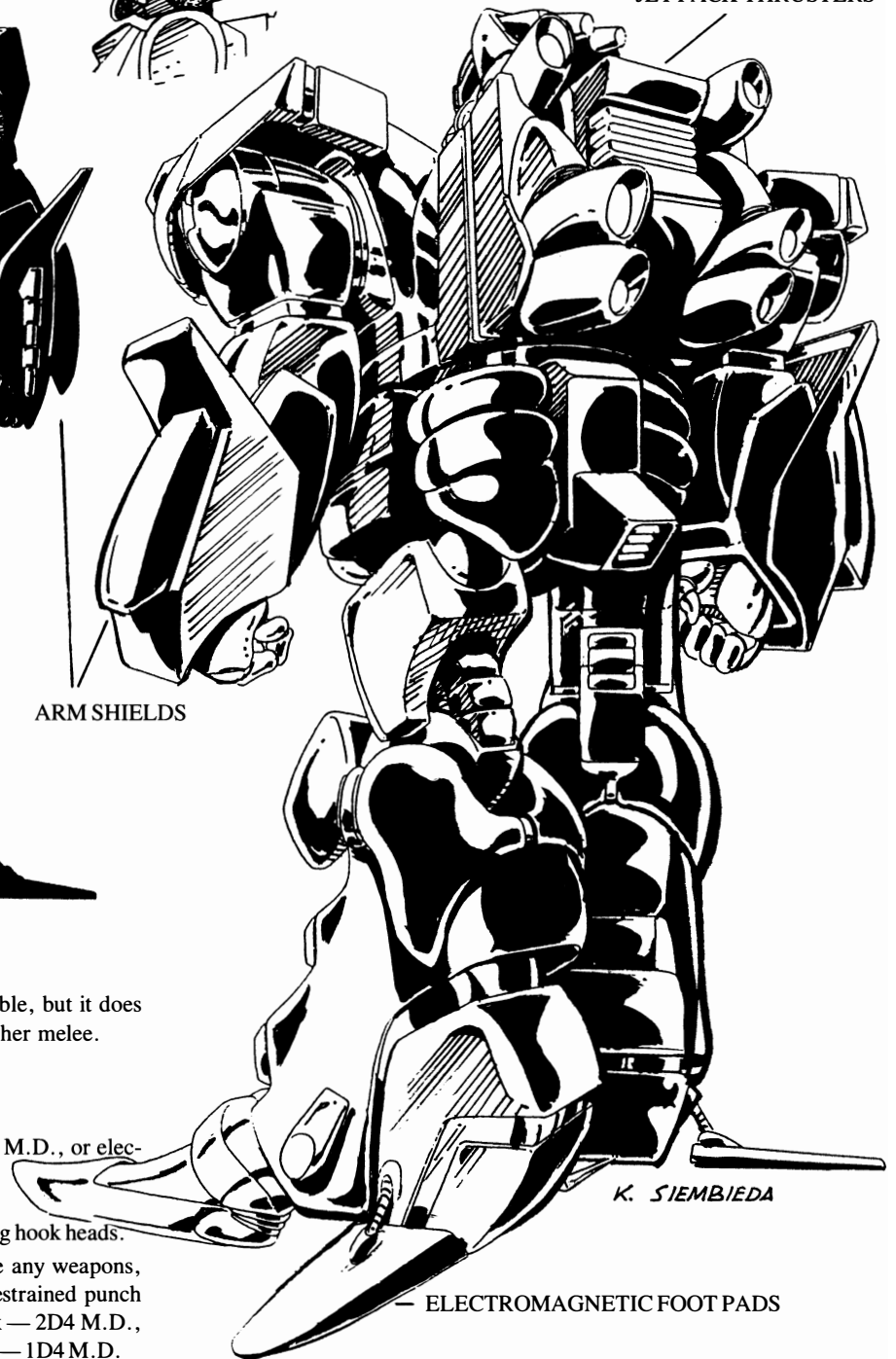

— ELECTROMAGNETIC FOOT PADS

3. **Optional use of the Towline** as a weapon is possible, but it does limited damage and can only be fired once every other melee.

Primary Purpose: Rescue/Recovery

Secondary Purpose: Defense

Range: 500ft (152.5m)

Mega-Damage: Spike or grappling hook head — 2D4 M.D., or electromagnetic head — 1D4 M.D.

Rate of Fire: Once every two melees or less.

Payload: 3 magnetic heads, 4 spikes, 4 spiked, grappling hook heads.

4. **Optional Hand to Hand Combat:** Rather than use any weapons, the battloid can engage in hand to hand combat. Restrained punch does 1D4 M.D., full punch — 2D4 M.D. body block — 2D4 M.D., kick — 1D6 M.D., leap kick — 2D6 M.D. and stomp — 1D4 M.D.

C.D.C. HEAVY BATTLOID

The second Civil Defense Corps Battloid is simply a more heavily armored version of the Light Battloid. The only visible dissimilarities are the design/shape of the head, the heavy head lasers, and slightly greater mass of the body. Another less obvious, difference is that the heavier armor provides more protection, but also makes the mecha heavier and slower. The C.D.C. Heavy Battloid is used by officers in conjunction with the more common Light Battloids (grunts). There is one heavy unit for every six lights.



Speed: Running — 45mph (72kmph), flight or hovering is impossible for this mecha. *Special maneuvers:* Thruster enhanced leaps up to 150ft (45m) high and 40ft (15.2m) long. Underwater travel with the 2 thrusters is a maximum of 8mph (12kmph).

Height: 20ft (6.1m)

Width: 9ft 7in (2.8m)

Length: 8ft (2.4m)

Weight: 12 tons

Main Engine: MT 845 Fusion Reactor

Weapon Systems

1. **High-Powered Head Lasers** are mounted on both sides of the head. The lasers can rotate up and down in a 90 degree angle and can be fired one at a time or simultaneously.

Primary Purpose: Anti-Vehicle

Range: 4000ft (1200m)

Mega-Damage: 2D6 M.D. for one laser, or 4D6 M.D. if both are fired simultaneously (counts as one attack).

Rate of Fire: Equal to the pilot's combined hand to hand.

Payload: Unlimited.

2. **EU-11 GunPod** (rifle) is usually standard issue. This is the identical weapon used by the Veritech Hover Tank.

Primary Purpose: Assault/Defense

Range: 6000ft (1800m)

Mega-Damage: 1D4 × 10

Rate of Fire: Equal to the pilot's combined hand to hand.

Payload: Unlimited.

3. **Optional use of the E-20 Gun Pod** (pistol). This is not standard issue, but can be used if available and needed. See the Logan Veritech Fighter for details.

4. **Optional Hand to Hand Combat:** Rather than use a particular weapon, the battloid can engage in hand to hand combat. Restrained punch — 1D4 M.D., full punch — 2D4 M.D., body block — 2D4 M.D., kick — 1D6 M.D., leap kick — 2D6 M.D. and stomp — 1D4 M.D.

Special Equipment: Same as the C.D.C. Light Battloid.

WEAPON COMBAT SUMMARY

Attacks Per Melee: Equal to the combined number of hand to hand attacks of the pilot. Usually 4 attacks at level one.

Head Lasers: 2D6 or 4D6 M.D.; Range: 4000ft (1200m).

EU-11 Gun Pod: 1D4 × 10 M.D.; Range: 6000ft (1800m).

Alternate Modes of Attack:

Use of the E-20 Gun Pod; hand held; see Logan Veritech.

Hand to Hand Combat: Punch, kick, body block.

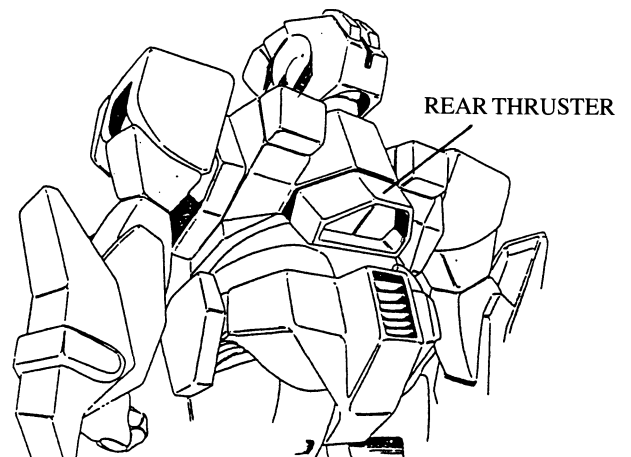

C.D.C. HEAVY BATTLOID

CIVIL DEFENSE CORPS HEAVY BATTLOID

Vehicle Type: Non-Transformable Combat Battloid

Crew: One, and can accommodate one additional passenger.

M.D.C. by Location:

Head — 40

Head Lasers (2) — 20 each

Head Spotlight — 10

Upper Arms — 80 each

Forearms/Shields (2) — 400 each

Legs — 100 each

Hands — 30 each

Rear Thruster — 50

Directional (grill) Thruster — 20

Reinforced Pilot's Compartment — 110

*Main Body — 150

EU-11 or E-20 — 100

*If the M.D.C. of the main body is depleted, the mecha shuts completely down.

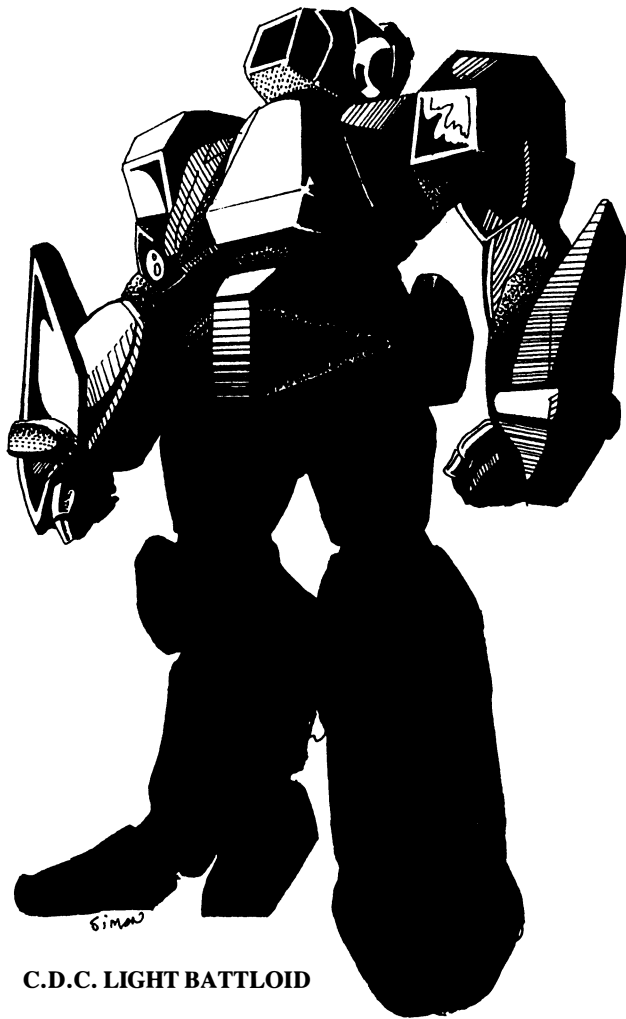

C.D.C. LIGHT BATTLOID

C.D.C. LIGHT BATTLOID

The Civil Defense Corps has two battloids designed for urban combat, riot control and police action. Both have heavy parrying shields attached to the arms, spotlights built into the head, and booster jet thrusters built into the back. The jet thruster on the back is to aid the battloid in leaping, jumping and limited underwater activity.

The C.D.C. Light Battloid is the fundamental civil defense mecha used by the mecha pilot grunts of the Civil Defense Corp. The heavier version is the officer's model.

CIVIL DEFENSE CORPS LIGHT BATTLOID

Vehicle Type: Non-Transformable Combat Battloid

Crew: One, and can accommodate one additional passenger.

M.D.C. by Location:

- Head — 30
- Head Mini-Lasers (2) — 10 each
- Head Spotlight — 10
- Upper Arms — 70 each
- Forearms/Shields (2) — 300 each
- Legs — 100 each
- Hands — 30 each
- Rear Thruster — 50
- Directional (grill) Thruster — 20
- Reinforced Pilot's Compartment — 100
- *Main Body — 100
- EU-11 or E-20 — 100

*If the M.D.C. of the main body is depleted, the mecha shuts completely down.

Speed: Running 80mph (128kmph); flight or hovering is impossible for this mecha. *Special maneuvers:* Thruster enhanced leaps up to 200ft (61m) high and 60ft (18.3m) long. Underwater travel with the 2 thrusters is a modest 12mph (19kmph).

Height: 20ft (6.1m)

Width: 9ft (2.7m)

Length: 8ft (2.4m)

Weight: 8 tons

Main Engine: MT 845 Fusion Reactor

Weapon Systems

1. **Mini-Head Lasers** are mounted on both sides of the head. The lasers can rotate up and down in a 60 degree arc and can be fired individually or simultaneously.

Primary Purpose: Antipersonal

Range: 2000ft (600m)

Mega-Damage: 1D6 for one laser, or 2D6 M.D. if both are fired simultaneously (counts as one attack).

Rate of Fire: Equal to the pilot's combined hand to hand.

Payload: Unlimited.

2. **E-20 Gun Pod** (pistol) is usually standard issue. This is the identical weapon used by the Logan Veritech Fighter.

Primary Purpose: Defense

Range: 4000ft (1200m)

Mega-Damage: 1D4 × 10 M.D.

Rate of Fire: Equal to the pilot's combined hand to hand.

Payload: Unlimited.

3. **Optional use of the EU-11 Gun Pod.** This is not standard issue, but can be used if available and needed. See the Veritech Hover Tank for details.

4. **Optional Hand to Hand Combat.** Rather than fire weapons, the battloid can engage in hand to hand combat. Restrained punch does 1D4 M.D., full punch — 2D4 M.D., body block — 2D4 M.D., kick — 1D6 M.D., leap kick — 2D6 M.D. and stomp 1D4 M.D.

SPECIAL EQUIPMENT

1. Infrared and visible light spotlight located in the head. Range: 400ft (122m).

2. Rear, bottom mounted maneuvering jet for space and underwater.

3. Back mounted thruster jet for boosting leaps, and underwater and space mobility.

WEAPON COMBAT SUMMARY

Attacks Per Melee: Equal to the combined number of hand to hand attacks of the pilot. Usually 4 attacks at level one.

Mini-Head Lasers: 1D6 or 2D6 M.D.; Range: 2000ft (600m).

E-20 Gun Pod: 1D4 × 10 M.D.; Range: 4000ft (1200m).

Alternate Modes of Attack:

Use of the EU-11 Gun Pod; hand held, see VHT.

Hand to Hand Combat: Punch, kick, body block.

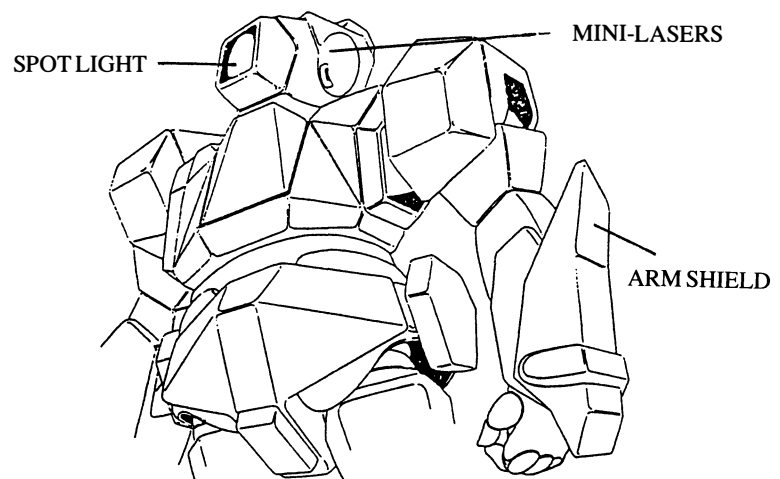

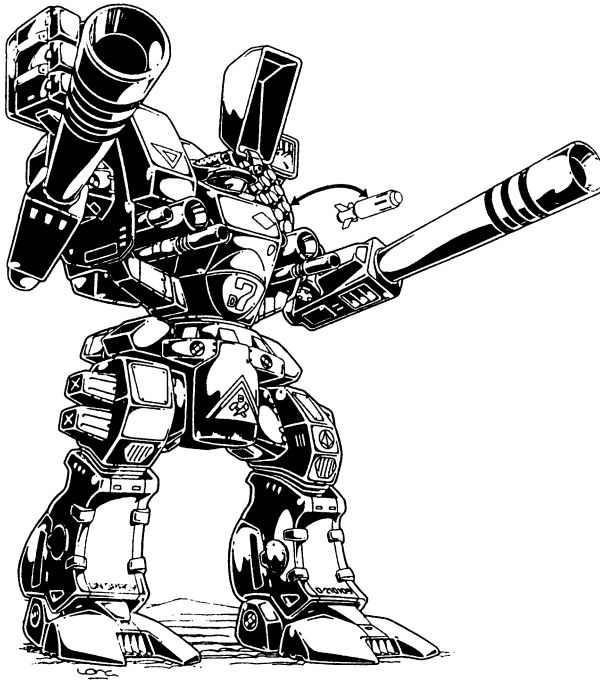

THE MECHA OF THE EASTERN BLOC SOVIET INDEPENDENT STATE (E.B.S.I.S)

The E.B.S.I.S. has grown into a major world power despite great losses in military campaigns to expand their nation. Their most costly *success* was a massive movement to claim the still mineral rich wastelands once known as the Middle East. The E.B.S.I.S. trek into the African Sector would have far greater global impact than anyone would ever suspect. An unexpected amount of rogue Zentraedi activity became quickly apparent. As the E.B.S.I.S. forces pressed toward the *Congo Quadrant* through old Saudi Arabia, Egypt, Sudan and Ethiopia, Zentraedi resistance intensified. Suddenly, the E.B.S.I.S. occupation forces found themselves in a full-fledged war with the giant aliens. It seems that while the RDF had focused its attention on the Zentraedi rogue-occupied South American Sector, another, more organized, Zentraedi faction had amassed an army of frightening proportion in the Africa Sector. Headquartered in the jungles of the Congo Quadrant, they built their secret army with plans to sweep the unsuspecting North American Sector. When the RDF would rise to meet the new threat, the Zentraedi of the Arkansas Protectorate would strike from within, cutting the RDF in half. Fortunately, the E.B.S.I.S. expedition inadvertently stumbled into this Zentraedi hornet's nest, foiling their scheme.

Totally unprepared for the strength and number of the Congo Zentraedi, the Soviets suddenly found themselves in the middle of a war they could not win. A desperate plea for immediate help brought in the RDF and the then fledgling, Army of the Southern Cross Defense Corps. Even then it took the combined strength of all three forces to crush the Zentraedi threat in the Congo. This would spark rogue Zentraedi aggression worldwide, culminating in two years of global battles with the warring giants. In the end, the traitorous Zentraedi of the Arkansas Protectorate, Africa Sector, South American Sector and the North American Sector wastelands would be destroyed. The Zentraedi threat apparently ended once and for all. Though costly in lives and mecha, the E.B.S.I.S. would find itself dominating the lands they sought, insuring their continued growth as an independent state.

The Africa Sector conflict and other, less successful, military campaigns exhausted the E.B.S.I.S.'s modified Zentraedi, and bootlegged RDF mecha. Rather than invoke the ire of the RDF with continued piracy of their mecha, the Soviets developed their own line of combat mecha. The emphasis of design is the battloid, a configuration that always intrigued them most.

The E.B.S.I.S. Battloids are huge, massive machines patterned more on the old RDF Gladiator and VF series Veritech Battloid rather than the move to smaller, faster mecha by the Southern Cross. One reason for the larger size may be to accommodate the nuclear power source and generators of the mecha. Since protoculture is not readily available, the E.B.S.I.S. has opted for more conventional power systems. Only top officers have protoculture based mecha. However, the ingenuity of the E.B.S.I.S. has compensated well for the lack of protoculture enhanced mecha. Voice actuated controls, combat computers, and their "tele-mental" helmet, has produced impressive, quick responding battloids. *The tele-mental helmet* is tied directly into a computer system that reads electromagnetic impulses from the human brain and translates them into mechanical responses.

By the beginning of the Second Robotech War, the E.B.S.I.S. had amassed a formidable army of battloids. However, except for a few minor skirmishes, the Soviets will elect to stay out of the Second Robotech War. It is a move that will drain the Southern Cross, splinter the last vestiges of the United Earth Government, and make the E.B.S.I.S. the world power at the war's end. This will be a short-lived dominance that will end in obliteration at the hands of the invading *Invid* less than a decade later.

THE MECHA OF MACROSS

The mighty, metal titans of the First Robotech War still exist, but are generally thought of as obsolete. A huge number have been modified or cannibalized into the new, smaller, mecha of Southern Cross. The majority of these weapon systems have been taken by Rick Hunter on the SDF-3. After all, they are the mecha of the RDF and not the Army of the Southern Cross. Others have been stolen, or infiltrated to high-tech pirates or to independent governments. Others are still active in the few, remaining, small RDF bases and Southern Cross mecha storage areas. Of all the original mecha, not more than 34% still remains on Earth and those are scattered around the world.

The least common are the VF series of Veritech Fighters. It is believed that less than two dozen exist in the world. The M.A.C. II is next in line for scarcity, with perhaps a total of three or four dozen worldwide. The most common are the once very heavily, mass produced Raidar X and Gladiators, which were still being manufactured as recently as eight years ago. But remember, the dominance of the RDF and Destroids began to fade more than a decade ago, and ended a few years later when the SDF-3 left on its mission to the stars.

THE ZENTRAEDI

Late in the year 2019 and 2020 the Zentraedi threat was ended with the destruction of the Arkansas Protectorate and a series of bloody battles in the South American Sector, Western Wastelands and African Sector. Most of the *loyal Zentraedi* had been micronized and left with the SDF-3 forces, or transferred to space outposts on the Moon, Mars and space stations. The majority of humans believe the Zentraedi to be extinct on Earth. This is a fallacy. Recent data attests to minimal, rogue Zentraedi activity in the South American Sector and the Eastern Sector. Zentraedi allies and mecha are still utilized by the E.B.S.I.S., but to a lesser degree than 15 years earlier. A series of ill-fated military campaigns by the E.B.S.I.S. over the last decade has depleted most of their Zentraedi troops and mecha.

The most common Zentraedi mecha used by rogue forces, mostly full sized, are the Tactical Battle Pod, Light Artillery Battle Pod and Officer's Pod. It's estimated that fewer than 2000 rogue (non-allied) Zentraedi still remain on Earth around the time of the *Second Robotech War*. Since their activity is restricted to the most desolate and primitive sectors, the belief that the Zentraedi are extinct is perpetuated.

THE E.B.S.I.S. SOLDIER BATTLOID

The Soldier Battloid is a mass produced, one man, frontline, infantry unit designed specifically as a land-based war machine. It can be easily recognized by its "Popeye"-like arms, very round contours and bulbous features. Two, huge power cords wrap around the chest and back. Its feet are cleated for better traction and two, small, jet thrusters, built into the calves of both legs, provide additional lift and speed. Augmented by the leg thrusters, the Soldier Battloid can perform jet boosted leaps and trudge through deep snow, mud, and swamps, and it even provides limited underwater and space capabilities.

The only built-in weapon system is the E.B.S.I.S.' now infamous, *plasma generator*. This unique device generates and fires bolts of plasma energy (Mega-Damage). The small square mouth-like appendage in the head is the weapon nozzle.

The only other weapon used by the Soldier Battloid is the *A.K.G.-47*, 55mm, three barrel, gun pod. Yes, your suspicions are right. The *A.K.G.-47* is the Soviet version of the RDF *GU-11 gun pod*. Except for a few stylistic changes, the weapon even looks identical to the outmoded *GU-11*.

Note: E.B.S.I.S. battloids are NOT laser resistant nor do they utilize parrying shields.

E.B.S.I.S. SOLDIER BATTLOID

Vehicle Type: Non-Transformable Combat Battloid

Crew: One; no passenger.

M.D.C. by Location:

- Head — 60
- *Head Plasma Weapon Nozzle — 30
- Hands — 20 each
- Arms — 70 each
- Legs — 120 each
- Leg Booster Jets (4) — 10 each
- **Power Cords (2 front/2 back) — 25 each
- Reinforced Pilot's Compartment — 100
- ***Main Body — 200
- A.K.G.-47 Gun Pod — 75

*The small size of the plasma weapon nozzle makes it a difficult target to hit, especially if the battloid is moving. Thus, the following penalties apply when somebody is attempting to hit (called shot) the weapon nozzle: -4 to strike standing still or -8 to strike when battloid is moving.

**The power cords are perhaps the battloid's most vulnerable weakness. If one is destroyed there is no affect. Two destroyed reduces the plasma attacks to 2 per melee and reduces the battloid's speed by 25%. If three are destroyed, the plasma generator can fire only once per melee and speed is reduced by half. Destroy all four cords; the plasma weapon can NOT fire and speed drops to 10mph, and the mecha will shut down/immobilize within 2D4 minutes.

***If the M.D.C. of the main body is depleted, the mecha shuts completely down.

Speed: Running is 50mph (80kmph), leap — 10ft high and across, jet boosted leap — 20ft (6.1m) high and across. Underwater with booster leg jets — 8mph (12.8kmph).

Height: 35ft (10.7m)

Width: 15ft (4.6m)

Length: 9ft (2.7m)

Weight: 18 tons

Main Engine: KR-T66 Fusion Reactor

Weapon Systems

1. **Plasma Ejector/Generator:** The plasma weapon nozzle is located in the lower face plate of the head. It is from this nozzle that bolts

of plasma energy can be fired. To shoot at different angles the entire head must turn. 180 degree rotation left and right and 45 degrees angle up and down, are the limits of head movement.

Primary Purpose: Assault/Defense

Range: 2000ft (600m)

Mega-Damage: 6D6 M.D.

Rate of Fire: Limited to two per melee to prevent overheating.

Payload: Conditionally unlimited; 40 blasts maximum within one hour or less. Regenerates at a rate of 10 per hour.

2. **AKG-47 Gun Pod** (rifle) is essentially the *GU-11* gun pod, 55mm, three-barreled gun pod. Standard issue to all units.

Primary Purpose: Anti-Personnel

Secondary Purpose: Assault/Defense

Range: 4000ft (1200m)

Mega-Damage: Does 3D6 M.D. — short burst, 6D6 M.D. — long burst or 1D6 × 10 M.D. for full melee burst.

Payload: 200 rounds per clip equals 20 short bursts or 10 long bursts or 5 full melee bursts or any combination thereof. Additional ammo clips can be engaged, but require half a melee, meaning that the player loses half his attacks that melee.

3. **Optional Hand to Hand:** Punch does 1D4 M.D., or full punch does 2D4 M.D., body block — 1D4 M.D., kick — 1D6 M.D., stomp — 1D4 M.D.

WEAPON COMBAT SUMMARY

Attacks Per Melee: Equal to the combined number of hand to hand attacks of the pilot. Usually four at first level.

Plasma Ejector: 6D6 M.D.; Range: 2000ft (600m).

AKG-47 Gun Pod: 3D6, 6D6 or 1D6 × 10 M.D.; Range: 4000ft (1200m).

Alternate Mode of Attack:

Hand to Hand Combat: Punch, kick, block, flip, stomp.

SOLDIER BATTLOID (E.B.S.I.S.)

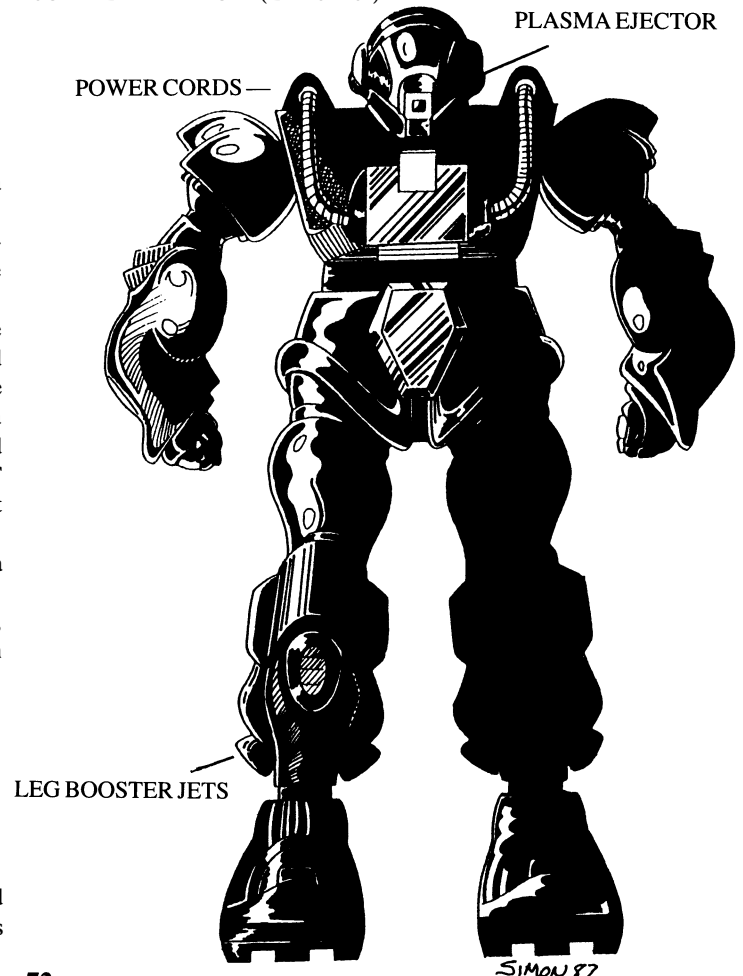

JUGGERNAUT BATTLOID (E.B.S.I.S.)

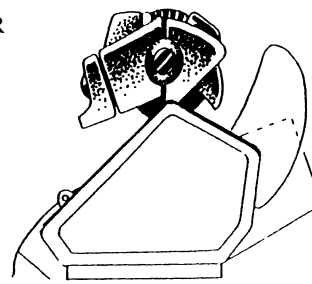
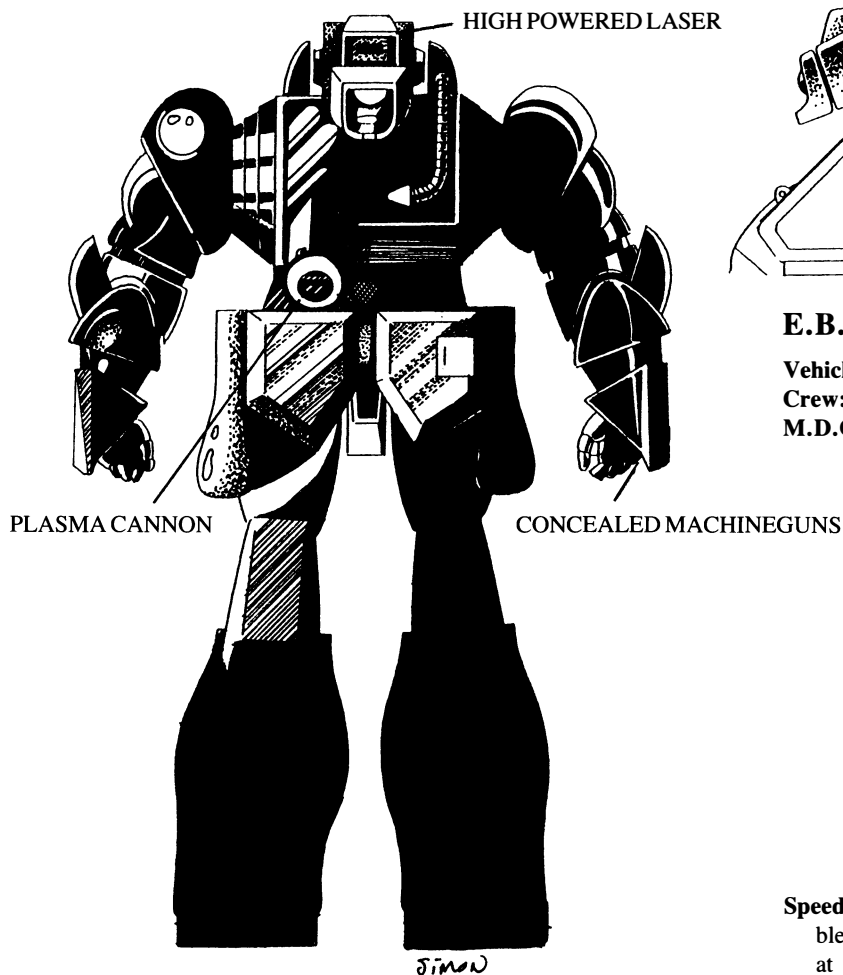

HEAD SIDE VIEW

E.B.S.I.S. JUGGERNAUT BATTLOID

Vehicle Type: Non-Transformable Combat Battloid

Crew: One; no passengers.

M.D.C. by Location:

Head — 80

Head Laser — 40

Head Spotlight — 10

Hands — 30 each

Hand: Protective Sleeves — 30 each

Hand: Machineguns (2 pair) — 10 each

Plasma Cannon (1) — 75

Arms — 150 each

Legs — 200 each

Power Hoses (2) — 50 each

Reinforced Pilot's Compartment — 100

*Main Body — 300

AKG-47 Gun Pod — 75

*If the M.D.C. of the main body is depleted, the mecha shuts completely down.

Speed: Running — 30mph (48kmph) maximum. Leaps are impossible. Underwater capabilities are limited to walking along the bottom at 15mph (24kmph).

Height: 37ft (11.6m)

Width: 19ft (6m)

Length: 11ft (3.3m)

Weight: 22.6 tons

Main Engine: KR-T89 Fusion Reactor

Weapon Systems

1. **High-Power Laser** is mounted on top of the mecha's head. The angle of fire is limited by head movement — 45 degrees up and down, 90 degrees from side to side.

Primary Purpose: Assault/Defense

Range: 4000ft (1200m)

Mega-Damage: 3D6 M.D.

Rate of Fire: Equal to the pilot's combined hand to hand attacks.

Payload: Unlimited.

2. **Two Pairs of Concealed, Twin Machineguns** are built into the wrists and protected by armored, metal sleeves. To destroy the machineguns (M.D.C. 10), the protective covering (M.D.C. 30) must be destroyed first.

Primary Purpose: Assault/Defense

Range: 2000ft (600m)

Mega-Damage: 2D4 M.D. for short bursts. 4D4 M.D. for long bursts or 1D4 × 10 M.D. for one full melee of continuous fire (each burst is considered to be one attack, regardless of the length).

Payload: 3000 rounds *each arm*. One short burst uses 10 rounds (that's 300 bursts), one long burst uses 20 rounds (that's 150 bursts) and one FULL melee burst uses 40 rounds (75 bursts).

3. **The Plasma Cannon** built into the chest is the most lethal weapon of the battloid's armaments. It is fixed forward, but can fire at a 90 degree angle up and down. To turn, the whole mecha must turn.
Note: The Juggernaut can swivel 180 degrees at the waist.

THE E.B.S.I.S. JUGGERNAUT

The Juggernaut is the E.B.S.I.S.'s latest achievement in mecha design. It too is a frontline combat unit designed as the heavy guns of the mecha infantry. It is a 37ft (11.3m), one man, killing machine. Although still characterized by round, bulbous contours, the Juggernaut is clearly more powerfully built than the Soldier Battloid. The mecha itself is incredibly tough and can sustain substantial damage before suffering serious impairment. However, the weight of the heavy armor and elaborate weapon systems makes it a slow-moving assailant and prohibits leaping. Still, it is not a machine to be taken casually.

Atop the head is a high-powered laser. Below it is a high intensity spotlight. Metal sleeves cover both hands and wrists, concealing the twin 12.7mm machineguns. To fire, the mecha need only point at its target and the pilot hit his trigger controls. The most devastating weapon is the plasma cannon built into the lower right chest section. Unlike the Soldier Battloid, there is only one reinforced power hose on the front and back of the unit. If both are severed (M.D.C. depleted), the battloid has a power reserve that will last for 1 to 4 hours (roll 1D4). If on reserve power, the mecha can fire only 10 plasma bolts, but all other weapons continue to operate as normal. When reserve power is gone, the entire battloid and all its systems are immobilized. The destruction of one power hose has no adverse effect. The AKG-47 gun pod is also carried as a hand held weapon.

Primary Purpose: Assault/Defense

Range: 6000ft (1800m)

Mega-Damage: 1D4 × 10 M.D.

Rate of Fire: Equal to the pilot's combined hand to hand attacks.

Payload: Unlimited. Note that if both power hoses are destroyed (M.D.C. 50 each) the energy reserve is limited to 10 plasma blasts.

4. The AKG-47 Gun Pod (rifle), 55mm, three-barrel gun pod, is standard issue to all units.

Primary Purpose: Antipersonnel

Secondary Purpose: Assault/Defense

Range: 4000ft (1200m)

Mega-Damage: Does — 3D6 short burst, 6D6 for a long burst, or 1D6 × 10 M.D. for full melee burst.

5. Optional Hand to Hand Combat: Restrained punch does 1D4 M.D., full punch — 2D4 M.D., body block — 1D4 M.D., kick — 1D6 M.D., stomp — 1D4 M.D.

WEAPON COMBAT SUMMARY

Attacks Per Melee: Equal to the combined number of hand to hand attacks of the pilot. Usually four at first level.

High Power Laser: 3D6 M.D.; Range: 4000ft (1200m).

Twin Machineguns: 2D4, 4D4 or 1D4 × 10 M.D.; Range: 2000ft (600m).

Plasma Cannon: 1D4 × 10 M.D.; Range: 6000ft (1800m).

AKG-47 Gun Pod: 3D6, 6D6 or 1D6 × 10 M.D.; Range: 4000ft (1200m).

Alternate Mode of Attack:

Hand to Hand Combat: Punch, kick, block, flip, stomp.

E.B.S.I.S. RECON DESTROYER BATTLOID

The Recon Destroyer is an awkward looking monstrosity with disproportionately skinny arms, massive legs, semicircular shoulder connections, rectangular chest, square head with oval sensor dishes . . . , a walking geometrical design nightmare. Despite its odd appearance, the Recon Destroyer is a devastating war machine. *Its sole purpose is to seek out and destroy the enemy.* To implement this, the battloid has been fitted with numerous sensors and a sophisticated radar system. As an all terrain vehicle the feet are cleated for better traction. And both arms have a special towline for firing grappling hooks and spikes for climbing and retrieving objects. The towline can support a weight of up to 30 tons and can be fired a distance of up to 800ft (240m).

Weapons are limited to the hand held AKG-47 gun pod, and an array of short range missiles which can be fired from the chest.

E.B.S.I.S. RECON DESTROYER BATTLOID

Vehicle Type: Non-Transformable Combat Battloid

Crew: One; no passengers.

M.D.C. by Location:

Head — 40

Head Spotlight — 10

Oval Radar Dishes (2) — 10 each

Hands — 20 each

Arms — 70 each

Towline Shoulder Housing — 20

Chest Missile Bay — 150

Legs — 200 each

Reinforced Pilot's Compartment — 100

*Main Body — 200

AKG-47 Gun Pod — 75

*If the M.D.C. of the main body is depleted, the mecha shuts completely down.

RECON DESTROYER (E.B.S.I.S.)

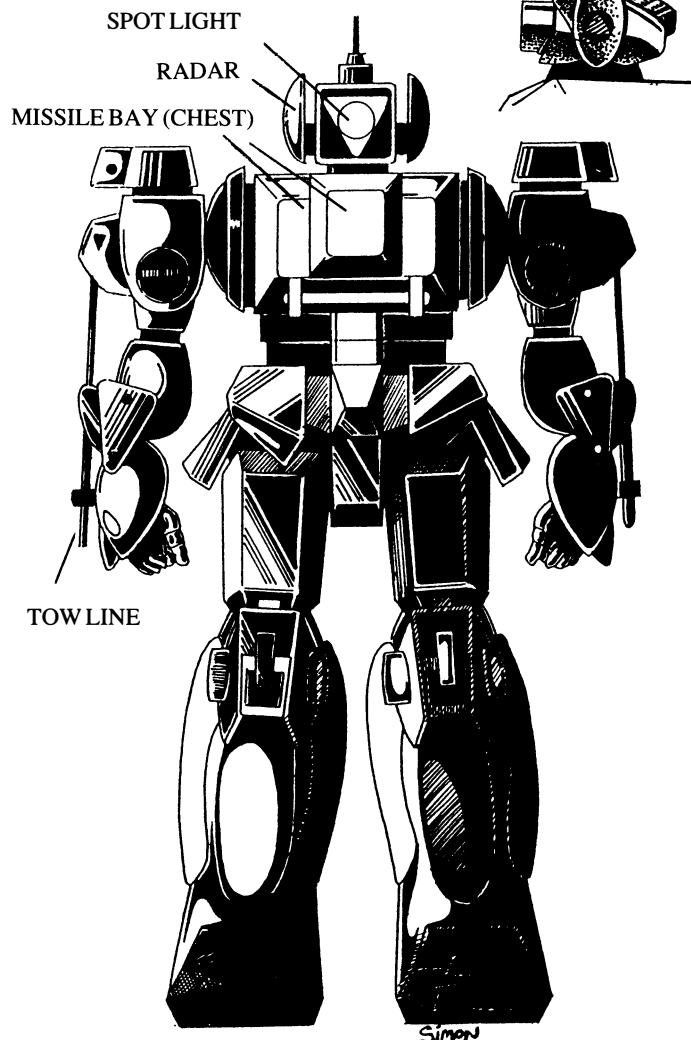

Speed: Running — 35mph (56kmph) maximum. Leaps are limited to 10ft (3m) high and 20ft (6.1m) across. Underwater capabilities are limited to walking along the bottom at 15mph (24kmph).

Height: 36ft (11m)

Width: 20ft (6.1m)

Length: 10ft (3m)

Weight: 20 tons

Main Engine: KR-T66 Fusion Reactor

Weapon Systems

1. A Short Range Missile Pod is located in the chest. The missile compartment/launcher is armored, protecting the missiles from detonation by enemy fire. The rectangular chest panel, with the square area in the center, flips open to reveal a battery of missiles. The chest panel must open to fire.

Primary Purpose: Assault/Defense

Missile Type: Short range, guided missiles; specific warheads vary widely. All warheads (listed in the Robotech RPG Book One on page 39) are available in any combination.

Range: Varies with specific missiles, usually about 2 miles.

Mega-Damage: Varies with missile type.

Rate of Fire: One at a time or volleys of two, three, four, six, or eight, fired simultaneously. Remember, a volley counts as one attack.

Payload: 32 total, short range missiles. Manual reload, from somebody outside, requires proper equipment and takes 6 melees.

2. **AKG-47 Gun Pod:** See the Soldier or Juggernaut Battloids for description.
3. **Optional Hand to Hand Combat:** Restrained punch does 1D4 M.D., full punch — 2D4 M.D., body block — 1D4 M.D., kick — 1D6 M.D., stomp — 1D4 M.D.
4. **Optional use of the Towline** as a weapon is possible, but inflicts minimal damage.

Primary Purpose: Climbing/Excavation

Range: 800ft (240m)

Mega-Damage: 1D4 M.D.

Rate of Fire: Once per each arm, per melee.

SPECIAL EQUIPMENT

1. **Rotating Arms:** The arms of the battloid can rotate in a 360 degree circle.
2. **High Intensity Spotlight** in the head with visible and infrared, light beam. Range: 500ft (150m).
3. **Long-Range Laser Communications System.** Range: 1200 miles, or indefinitely by satellite relay.
4. **Advanced Radar and Sensory Unit** mounted on the head. Radar can identify and track 50 targets simultaneously.

Other Sensors Include . . .

Heat: Can pick up and pinpoint heat emanations. Excellent for tracking and night fighting. Range: 600ft (180m).

Motion: Detects and registers movement within, 600ft (180m) radius.

Radiation: Detects and registers levels of radiation, pinpointing areas of specific concentration. Range: 1600ft (488m).

Seismic: Detects and measures seismic disturbances, including heavy movement by 2 or more mecha, or truck/troop/vehicle convoy. Range is limited to 1000ft (300m).

WEAPON COMBAT SUMMARY

Attacks Per Melee: Equal to the combined number of hand to hand attacks of the pilot. Usually four at first level.

Short Range Missiles: 32 — total payload. Damage and range vary.

AKG-47 Gun Pod: 3D6, 6D6 or 1D6 × 10 M.D.; Range: 4000ft (1200m).

Alternate Modes of Attack:

Towline; 1D4 M.D.; Range: 800ft (240m)

Hand to Hand Combat: Punch, kick, stomp, block, flip.

RDF “SURPLUS” MECHA OF THE E.B.S.I.S

Since Rick Hunter and the RDF have left Earth on the SDF-3, RDF mecha is a rarity. However, in addition to the handful still in service, there are the old, worn out models sold to friendly feudal states and those stolen by high-tech pirates. The E.B.S.I.S. was one of the greatest purchasers and acquirers (theft) of RDF mecha. Many have been lost in military campaigns, but quite a few are still actively in use. The following are the types currently (circa 2030) in the E.B.S.I.S. armed forces. Most are old, used or stolen, and have been rebuilt, or remodeled.

Note: Even though the E.B.S.I.S. technology level has risen by 2030, they still lack the ability to completely refurbish RDF mecha and have very little knowledge of protoculture or transformable mecha.

All RDF Mecha of the E.B.S.I.S. are rebuilt and suffer the following penalties:

1. Minus (–) 50 M.D.C. from the main body.
2. Minus (–) 25 M.D.C. from reinforced crew compartment.
3. Minus (–) 20% from speed (reduced mobility).
4. Lack of energy weapons.

EXCALIBER (13 in Service)

- 3 fully operable with complete armaments.
- 10 without functioning P-Beams, but full missiles and functioning

lasers, auto cannons and machineguns.

GLADIATORS (60 in Service)

- 17 original, fully operable with complete armaments.
- 43 Type III-G. Rebuilt Gladiators with complete armaments. This Destroid was always a favorite of the E.B.S.I.S. and the inspiration for their own series of battloids.

M.A.C. II (1 in Service)

- One fully operational M.A.C. II.

SPARTAN (None in Service)

VF SERIES VERITECH FIGHTERS (Special)

- 2 fully functioning, transformable VF-1A's.
- 12 VF-Type Bs; reconstructed Battloid mode Veritechs which can no longer transform into the other modes. Armed with AKG-47 gun pods (the Soviet version of the GU-11) and laser head turret.

ZENTRAEDI MECHA OF THE E.B.S.I.S.

Most of the Zentraedi soldiers recruited by the E.B.S.I.S. have died in earlier military campaigns. Or their mecha's protoculture power supplies have faded completely. Attempts to modify Zentraedi mecha for human pilots have been abandoned in favor of the new, nuclear powered *Battloids*.

Of the almost 4000 Zentraedi mecha, less than five dozen remain by the *Second Robotech War*. They include:

38 Tactical Battle Pods

5 Light Artillery Pods

6 Officer's Battle Pods

1 Male Power Armor

3 Female Power Armor

2 Reentry Pods

1 **Cyclops, Theatre Scout Recon Pod.** Modified for a human crew of 8.

Zentraedi soldiers: full size — 42 total. Micronized — none.

Note: The conventional E.B.S.I.S. vehicles listed in the *RDF Manual*, pages 31 and 32, are still in use, as are the weapons, equipment and vehicles listed in the *ROBOTECH® RPG*, pages 76-81.

Germany, Poland and Russia comprise the United Eastern Bloc Soviet Independent State. The largest and most stable of the independent nations. They have refused all invitations to join the unification movement and have been actively soliciting against the recreation of the one world government.

Technologically, most of the cities and developed areas have progressed to be about equal to the late 1980's. Manufacturing capabilities are a bit less, about equal to the mid 1970's. Remote areas are on a par with the 1930's and, in some areas, back to peasant farms and nomadic wandering. The technology and ability to create and manufacture mecha, energy weapons, or to utilize Robotechnology, is new to the E.B.S.I.S. The Soviets are sophisticated and resourceful enough to repair and modify (always a few tech levels lower) old, RDF and Zentraedi mecha. They have also created their own non-protoculture powered mecha.

The E.B.S.I.S. is a potential hotbed for trouble. They are building a substantial Battloid army, complete with energy weapons. Activity in the black market arena remains high in the area of high-tech piracy and mecha retrieval. *See the R.D.F. Manual, pgs 28-32, for full details about the E.B.S.I.S.*

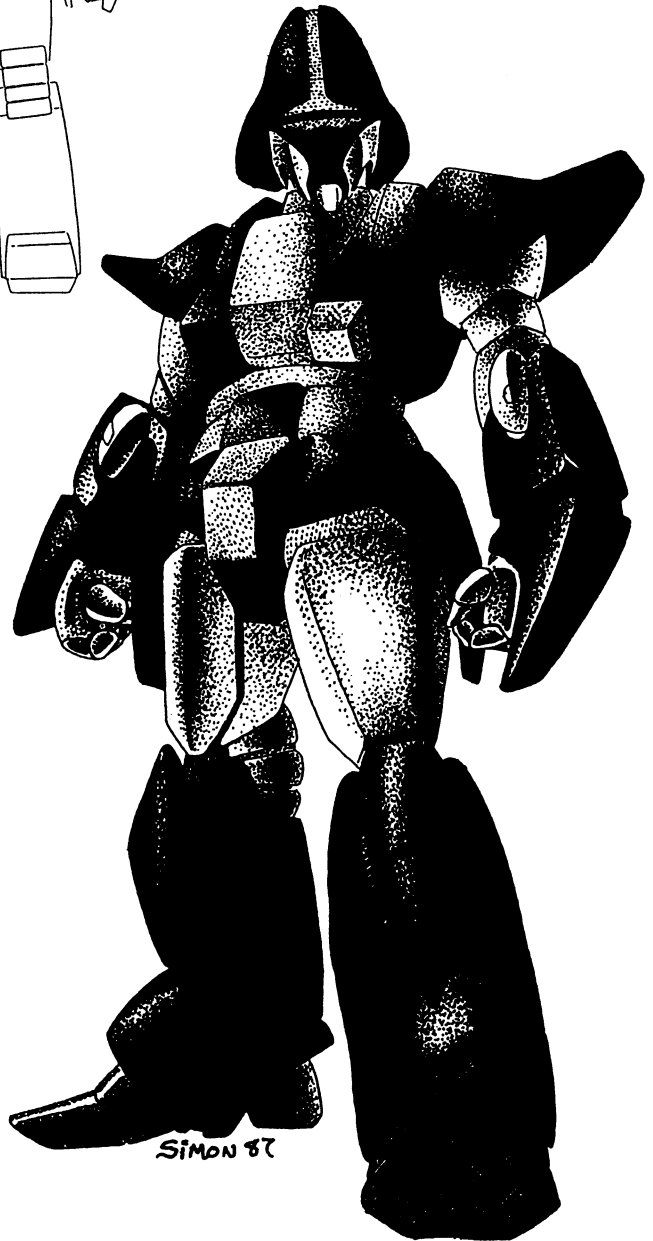
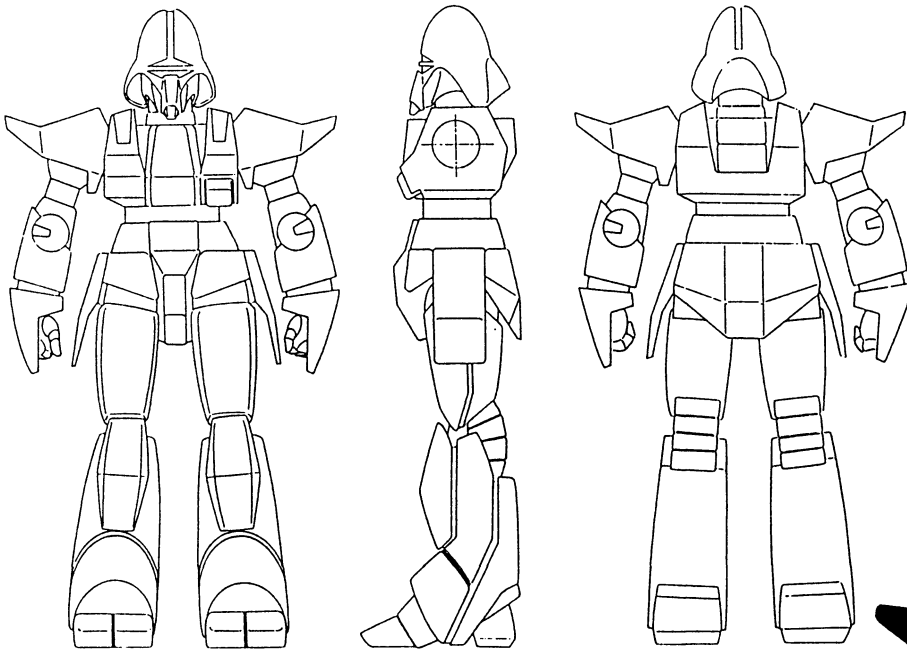

G.M.P. SECURITY ROBOT

One of the Global Military Police's (G.M.P.) great experiments was the development of a giant, mecha size, robot that could assist in policing, civil defense and security. Unfortunately, the final result is less than satisfactory. The robot is slow and ponderous in thought, reaction and mobility. Any mecha or battloid can run circles around it, as can most vehicles. Since the G.M.P. has invested so much time and money on the project, they have produced several dozen of these lumbering machines. Most are used as security guards and secondary defense units. They are most effective as an assistant to a human partner or team.

Features of Note Include:

Radio Communication: 50 mile range.

Audio Response: Understands sounds and words, and can speak.

Optic System: Visible light, infrared, passive nightvision (light amplification) and telescopic. Range for each is 600ft (183m).

Upper Torso Rotation: 360 degree mobility.

Laser Resistant Armor: Lasers (only) do half damage.

Speed: Running is 35mph (56kmph) maximum. No leaps or special maneuvers are possible.

Height: 15ft 6in (5.6m)

Width: 7ft 6in (2.3m)

Length: 4ft (1.2m)

Weight: 15 tons

Engine: R.I.-67 Fusion Turbine

Combat Capabilities:

Attacks Per Melee: One and always the last to respond. Never has initiative; horrible response time.

Bonuses: +1 to strike on a "called shot" only.

+1 to parry

No dodge

No roll with punch or fall

Mega-Damage: Restrained punch — 1D4 M.D.

Full strength punch — 2D4 M.D.

Body block/tackle — 1D6 M.D.

No Body Flip

No Kicks

No Stomp

Optional use of the EU-11 Gun Pod is common under combat conditions. +1 to strike with EU-11. Inflicts 1D4 × 10 damage; range: 6000ft (1800m).

M.D.C. by Location:

*Head/Optics and Audio — 50

Arms — 70 each

Legs — 100 each

Hands — 20 each

**Main Body — 200

*Depleting the M.D.C. of the head will not destroy the machine, but totally blind it. Radio communication contact can still be maintained to direct the robot and communicate.

**Depleting the M.D.C. of the main body will destroy the robot.

GROUND VEHICLES

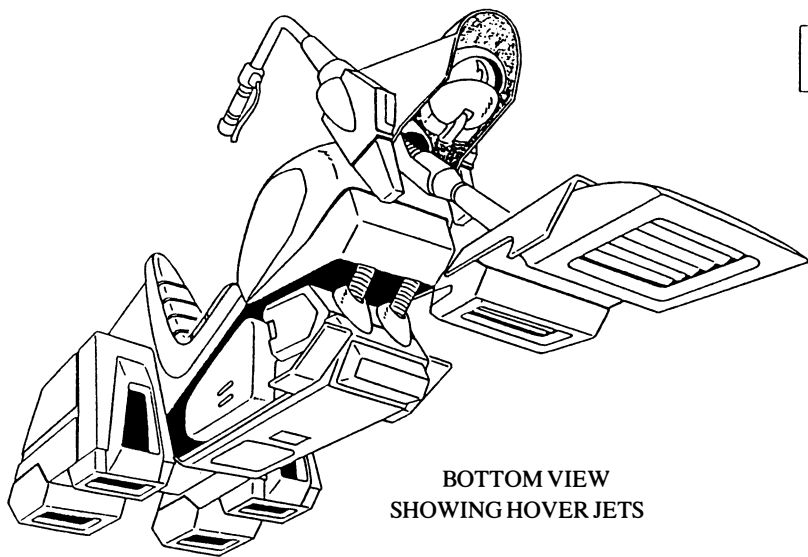

BOTTOM VIEW
SHOWING HOVER JETS

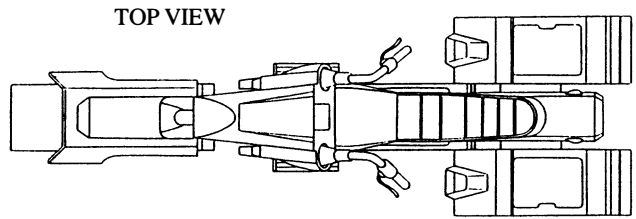

TOP VIEW

Although developed specifically for the Southern Cross, the hover cycle has become the favorite vehicle of high-tech pirates, as well as being adopted by several other governments. It is commonly used for scouting and personal transport. *The Armies of the Southern Cross* use the hover cycle for recon patrols, personal transport and by the Global Military Police (G.M.P.).

It is important to note that the hover cycle has no mounted or built-in weapons, but the driver may carry and fire any hand held weapon. The two storage compartments mounted on the rear hover jets can hold knives, pistols, hand held radio equipment, first-aid kit, water, nylon cord, and other items. Compartment size is 20 inches long, 12 inches wide and 17 inches deep (533.4 x 304.8 x 444.5m). Suggested weight allowance is 40lbs (18kg) each.

HOVER CYCLE

The hover cycle is an extremely mobile, high speed, combat and transport vehicle developed exclusively for the Army of the Southern Cross. The cycle's quiet engine and ability to traverse extremely rocky and rugged terrain makes it ideal for reconnaissance patrols. It's tri-hover jets make the cycle more stable than a conventional motorcycle, enabling its pilot to make sharp turns, jumps of up to 30 feet (9m) high, and attain speeds of up to 210mph. At normal cruising speed the hover cycle rides on jets of air, three to four feet off the ground. During high speed chases or on rugged, broken terrain, the vehicle adjusts to accommodate the environment, altering the height from three to ten feet high for short spurts. This amazing vehicle can even leap crevasses or chasms of up to 60ft (18m).

SIDE VIEW

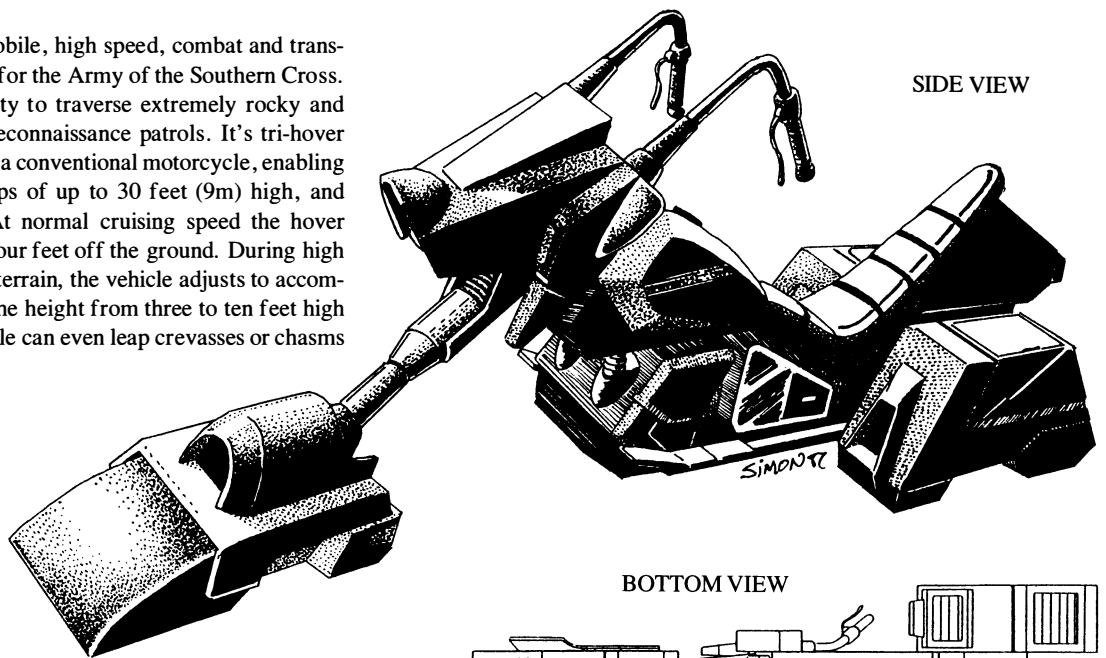

FRONT VIEW

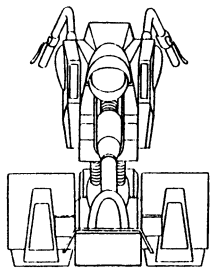

BOTTOM VIEW

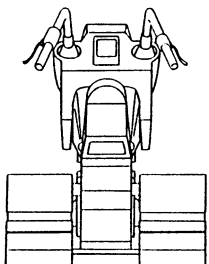
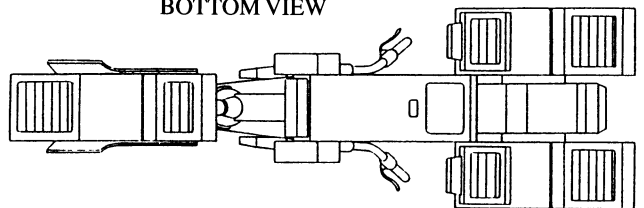

REAR VIEW

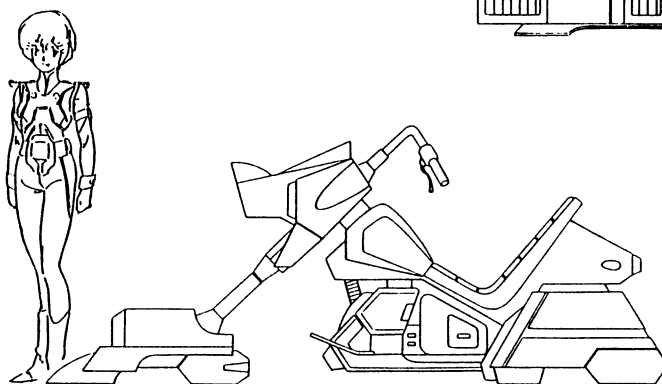

8ft 9in (2.6m)

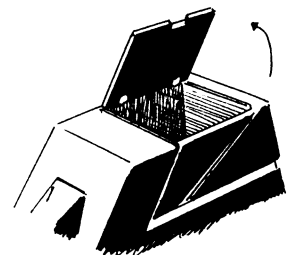

STORAGE COMPARTMENT

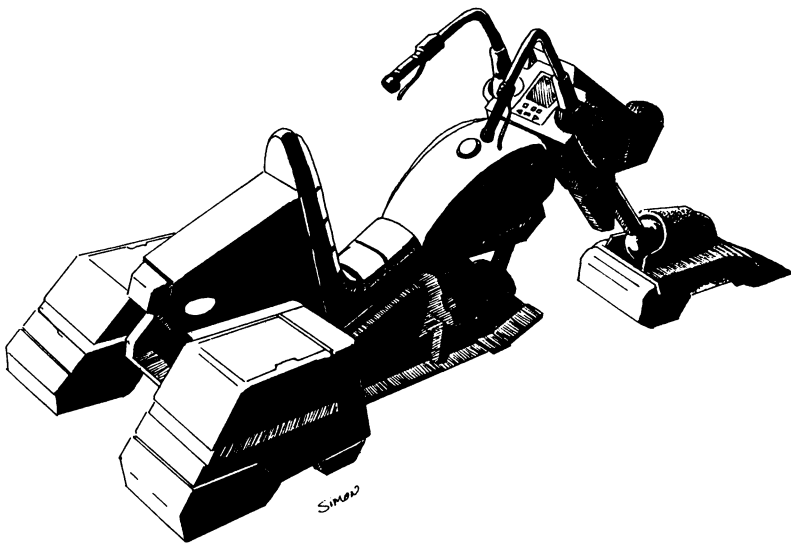

GMP LAND ROVER

The Global Military Police (GMP) Land Rover is a lightly armored transport and reconnaissance hover vehicle. It is a sturdy, open-air vehicle suitable for urban and wilderness patrols. As a hover vehicle it can easily traverse rugged terrain that conventional vehicles would find impassable. The GMP Land Rover normally travels on jets of air, two to three feet (.9m) above the ground, but can attain a height of up to 10 feet (3m) for brief intervals.

Hover land rovers of this variety are common throughout the world and are not exclusive to the Army of the Southern Cross.

Vehicle Type: Personnel Ground Transport.

Crew: One driver, and can comfortably accommodate four passengers.

M.D.C. by Location:

Headlights (2 pair) — 4 each

Hover Jets (4) — 50 each

Windshield — 30

*Main Body — 110

*If all the M.D.C. of the main body is depleted, the vehicle is destroyed.

Vehicle Type: Personal ground transport.

Crew: One pilot; one passenger is possible.

M.D.C. by Location:

Headlight (1) — 2

**Front Hover Jet — 20

**Rear Hover Jets (2) — 30 each

*Main Body — 50

*Depleting the main body M.D.C. will totally destroy the vehicle.

**Destroying the front hover jet makes the hover cycle inoperable. Destroying one of the rear hover jets reduces speed and jumps by half. Destroying both makes the vehicle inoperable.

Speed: Hover (stationary) 3 to 10ft (.9 to 3m) off ground, cruise speed — 70mph (112.63kmph), maximum speed — 210mph (337.8kmph). *Special maneuvers:* Boost/jump — 30ft (9m) high and up to 60ft (18m) long. Note: This vehicle can NOT fly in any sense of the word. Nor can it ride on bodies of water.

Height: 4ft (1.2m)

Width: 2ft 8in (.8m)

Length: 8ft 9in (2.6m)

Weight: 370lbs (166kg)

Engine: 1000cc Gas Turbine

Range: 1000 miles (1609km) at cruising speed, 800 miles (1287km) at maximum speed.

Weapons: None

Special Equipment:

High Intensity Headlight: 50ft Beam (15.2m)

Mini-Radar: Range: 4 miles (6.4km), but only 75% accurate and easily obscured by hills, mountains and forest.

Storage Compartments above the two, rear hover jets.

Radio/Video Communication: 100 mile range.

Instrument Display: Digital speedometer, fuel indicator.

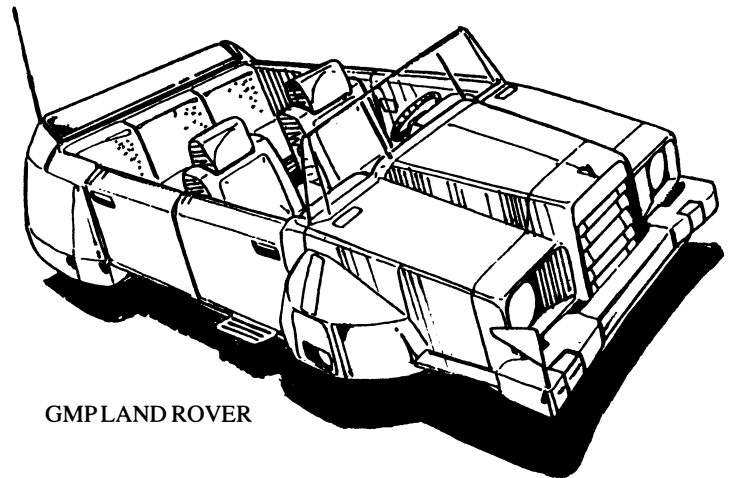

GMPLAND ROVER

Speed: Hover (stationary) 2 to 6ft (6. to 1.8m) off the ground, cruise speed — 50mph (80.5kmph), maximum speed — 180mph (289.62kmph). *Special maneuvers:* Boost/jump — 10ft (3m) high and up to 20ft (6m) long. Range: 500 miles (804.5km).

Height: 4ft (1.2m)

Width: 7ft (2.1m)

Length: 16ft (4.9m)

Weight: 2.5 tons

Engine: Gas Turbine

Weapons: None

Special Equipment:

Radio: Range: 50 miles (96.5km)

Mini-Radar: Range: 4 miles (6.4km), but only 75% accurate and easily obscured by tall buildings, hills, mountains and forest.

Loudspeaker: Amplifies voices by 90 decibels.

High Intensity Headlights: 50ft beam (15.2m).

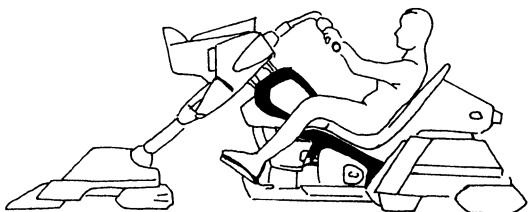

ARMORED HOVER LAND ROVER

This combat vehicle is basically like the GMP Land Rover, except that it is more heavily armored, larger, and can carry more troops. This is a combat field vehicle.

Vehicle Type: Personnel ground transport (combat).

Crew: One driver, and can comfortably accommodate eight passengers.

M.D.C. by Location:

Headlights (2 pair) — 4 each

Hover Jets (6) — 60 each

Windshield — 30

*Main Body — 160

*If all the M.D.C. of the main body is depleted, the vehicle is destroyed.

Speed: Hover (stationary) 2 to 6ft (.6 to 1.8m) off the ground, cruise speed — 50mph (80.5kmph), maximum speed — 120mph (193kmph).

Range: 500 miles (804.50km)

Length: 24ft (7.3m)

Weight: 4 tons

Engine: Gas Turbine

Weapons: None

Special Equipment:

Radio: Range: 300 miles

Radar: 30 miles (48.2km)

Loudspeaker: Amplifies voices by 90 decibels.

High Intensity Headlights: 50ft (15.2m) beam.

HOVER CARGO HAULER

This is a small, heavy-duty, equipment and cargo transport vehicle. The front section has an open cargo bay with a capacity of 10 tons. The rear section houses the engine and operator. The cargo hauler is used at Southern Cross Defense Corps bases and high-tech facilities. (Seen in episode #39).

Vehicle Type: Cargo and ground transport

Crew: One, with room for two passengers.

M.D.C. by Location:

Hover Jets (4) — 20 each

Front Cargo Area — 30

*Main Body — 75

*If all the M.D.C. of the main body is depleted, the vehicle is destroyed.

Speed: Hover (stationary) 2 to 10ft (.6 to 3m) off the ground, cruise speed — 25mph (40kmph), maximum speed — 45mph (72kmph). No special maneuvers are possible.

Height: 5ft (1.5m)

Width: 5ft (1.5m)

Length: 14ft (4.2m)

Cargo Capacity: 10 tons

Weight: 2 tons

Engine: Gas Turbine

Weapons: None

HOVER TRANSPORT TRUCK

A large, heavy, hover transport truck is also used by the Southern Cross. The front section looks much like the cab of any, large cargo hauling truck. The rear section is a long cargo bed that can be covered or left open.

Vehicle Type: Cargo ground transport

Crew: One, with room for two passengers.

M.D.C. by Location:

Hover Jets (10) — 20 each

Cab/Pilot Section — 30

Cargo Bed — 80

*Main Body — 140

*If all the M.D.C. of the main body is depleted, the vehicle is destroyed.

Speed: Hover (stationary) 2 to 20ft (.6 to 6.1m) off the ground, cruise speed — 60mph (96.54kmph), maximum speed — 90mph

(144kmph). No special maneuvers are possible.

Height: 15ft (4.6m)

Width: 8ft (2.4m)

Length: 25ft (7.6m)

Weight: 8 tons

Cargo Capacity: 100 tons

Troop Carrying Capacity: 60 to 72 soldiers

Engine: Gas Turbine

Weapons: None

MISSILE LAUNCHER

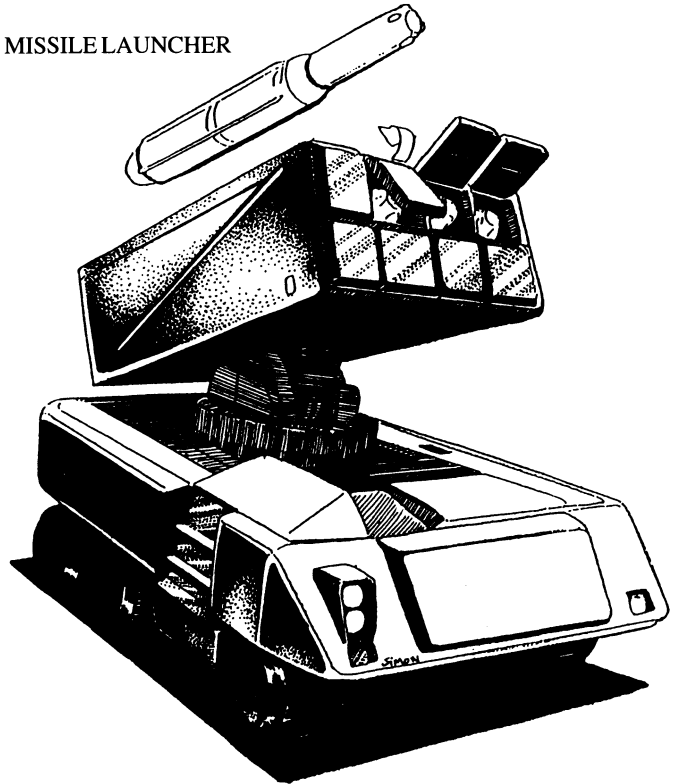

ATV MISSILE LAUNCHER

The Armies of the Southern Cross utilize an All Terrain Vehicle (ATV) missile launcher which can fire a volley of eight, long range missiles. Reloading is possible, but requires 6 to 8 minutes to do so. The huge, oversized wheels are designed to support the great weight of the vehicle and make it capable of traversing the broken terrain of the battlefield. The missile launcher pod is capable of 360 degree rotation and a 90 degree arc of fire (up/down).

Vehicle Type: Military, Combat

Crew: Three, with the capacity for three additional passengers.

M.D.C. by Location:

Wheels (6) — 20 each

Headlights (3) — 5 each

Rotor — 50

Missile Launcher — 150

*Main Body — 250

Reinforced Crew Compartment — 50

*If all the M.D.C. of the main body is depleted, the vehicle is destroyed.

Speed: Cruise speed is 14mph (22kmph), maximum speed is 30mph (48kmph). **Note:** The Missile Launcher is a completely self contained environment, and can function in space and underwater for a six hour period, before the air supply is depleted. No movement is possible in space. Underwater is limited to travel on the sea floor. Maximum Depth is 1 mile (1.6km); max. speed is 18mph (27kmph).

Maximum Range: 300 miles (482.70km).

Height: 26ft (7.7m) at full elevation.
Width: 10ft (3m)
Length: 22ft (6.8m)
Weight: 24 tons; 96 tons, fully loaded.
Engine: Gas Turbine

Weapon Systems

1. Eight Long Range Missiles

Mega-Damage: Varies with missile type.

Range: Varies with individual missile type.

Payload: 8 long range missiles. Reloading is possible with the proper machines and equipment. Reload time is 6 to 8 minutes. Mecha can also be used to reload the assault vehicle, but takes 10 to 15 minutes to completely reload. *Medium Range Missiles* can be substituted if necessary.

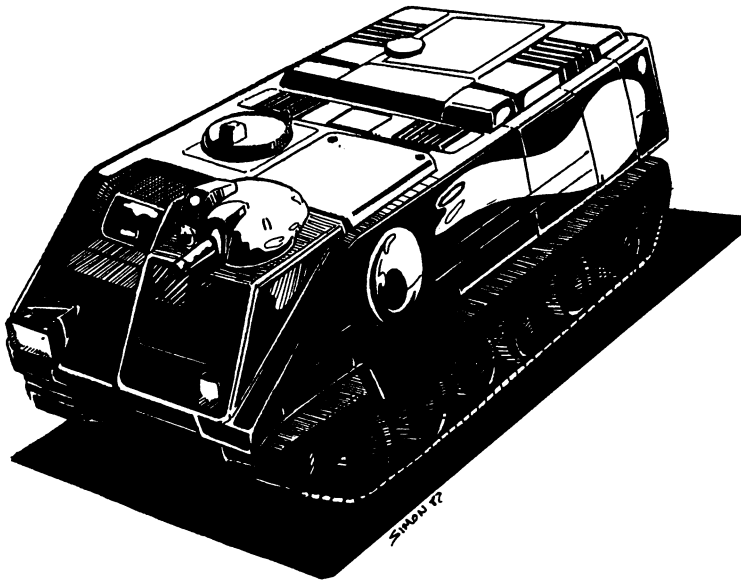

APT TANK CARRIER

A common assault vehicle is the Armored Personnel Transport Tank Carrier which delivers infantry troops to the battlefield and assist as support units. The main entrance/exit hatch is located in the rear. Two additional hatches are located toward the rear on either side, and two on the top. Both the crew compartment and personnel bay are airtight and reinforced.

Vehicle Type: Military Combat

Crew: Three, with room for two others in the crew compartment.

M.D.C. by Location:

- *Tractor Treads — 30
- Weapon Turret — 80
- Searchlight — 5
- Headlight — 2
- Main Hatch — 70
- Small Hatches (6) — 50 each
- Reinforced Crew Compartment — 70
- Reinforced Personnel Bay — 70
- **Main Body — 200

*Destroying the M.D.C. of one tread will impair movement; reduce speed by half. Destroying both treads will completely immobilize the vehicle.

**If all the M.D.C. of the main body is depleted, the vehicle is completely shut down and unsalvageable, but crew and troops *may* survive in their reinforced compartments.

Speed: Cruising speed on land is 50mph (80kmph), 75mph (121kmph) maximum; 10mph (16kmph) in water. No special maneuver are possible.

Maximum Range: 600 miles (965.5km)

Height: 10ft (3m)
Width: 16ft (4.9m)
Length: 34ft (10.5m)
Weight: 47 tons
Cargo Capacity: 30 tons
Troop Carrying Capacity: 32 soldiers in full gear.

Weapon Systems

1. Snub-Nosed, Self-Loading, Rapid Fire, Cannon: 45 degree angle of fire up and down, 360 degree rotation. Main gun.

Primary Purpose: Antitank

Range: 4000ft (1200m)

Mega-Damage: 1D4 x 10

Rate of Fire: Three per melee.

Payload: 60 rounds

2. 180mm Grenade Launcher is built into the weapon turret next to the main gun. 360 degree rotation of the turret is possible, but the arc of fire for the grenade launcher is a 30 degree angle.

Primary Purpose: Antipersonnel

Range: 4000ft (1200m); fragmentation affects all in a 20ft (6.1m) blast radius.

Mega-Damage: 4D6 M.D.

Rate of Fire: Twice per melee

Payload: 40 rounds

Total Attacks Per Melee: Five; 3 by the main cannon, 2 by grenade launcher.

CONVENTIONAL TYPE MILITARY AND COMMERCIAL VEHICLES

Conventional vehicles as listed in the *ROBOTECH® RPG*, pages 74-77, are still commonly used, as well as the conventional weapons and equipment on pages 77-81 of the RPG. The same is true of the items listed in the *RDF Manual*, pages 11-14.

AIR VEHICLES

CORSAIR III

The Corsair ground launched atmospheric fighter is the most devastating assault craft in the Southern Cross. It is capable of astounding speed, Mach 6, transatmospheric air/space capabilities, high mobility and a battery of missiles to supplement its rapid fire ion cannon.

Vehicle Type: Transatmospheric Fighter Air/Space

Crew: One; usually piloted by the T.A.S.C. or Cosmic Unit.

M.D.C. by Location:

- Ion Cannon — 70
- Missile Bay (3) — 110 each
- Wings (2) — 100 each
- Tail Fins (2) — 20 each
- Thrusters (4 in rear) — 75 each
- Reinforced Pilot's Compartment — 100
- *Main Body — 300

*Depleting the main body M.D.C. will totally destroy the aircraft. If the reinforced pilot's compartment is intact it can be jettisoned and parachute to safety. The emergency air supply in the pilot's compartment is restricted to 6 hours. *Destroying the tail fins* has no obvious effect on the vehicle. *Destroying one wing* will send the stricken aircraft into a dive to its doom. Parachuting to safety is the only chance for survival. The loss of one or both wings in space severely impairs mobility (no bonuses to dodge) and makes reentry impossible. Rescue is needed.

CORSAIR III

FRONT VIEW

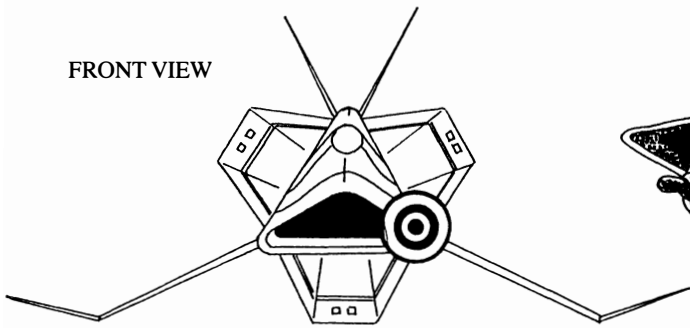

ION CANNON

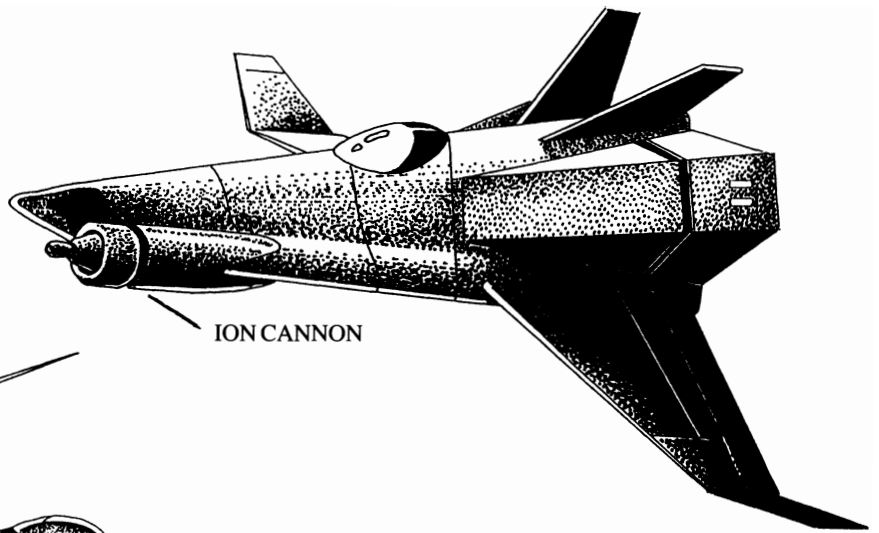

BOTTOM SIDE VIEW

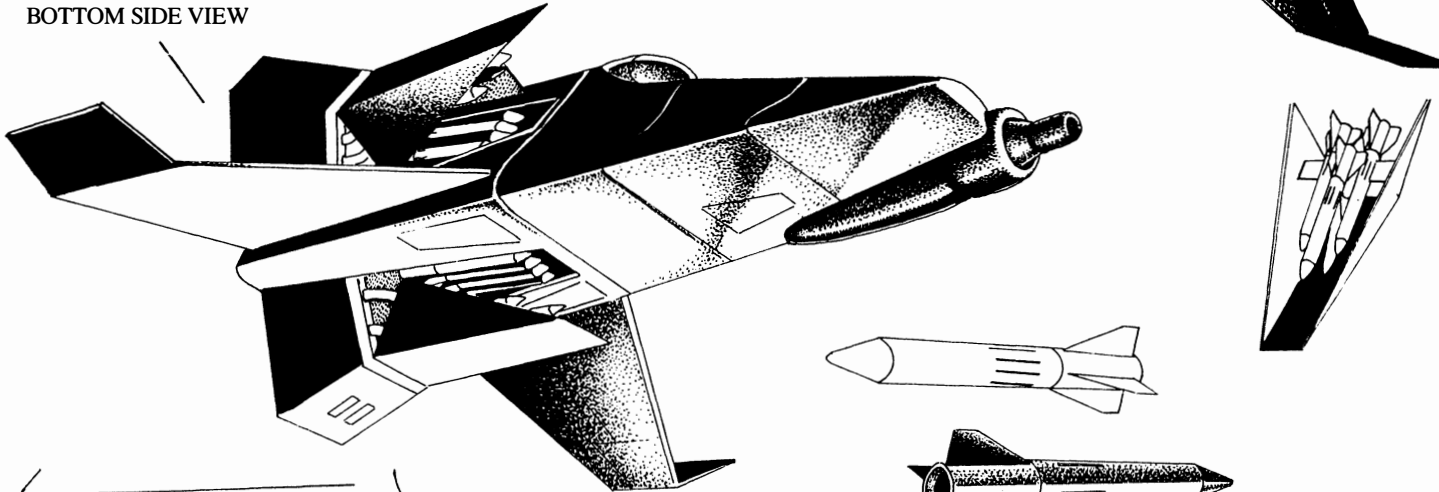

MISSILES

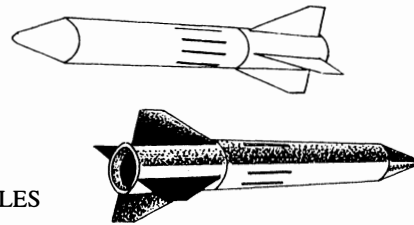

MISSILES READYING TO LAUNCH

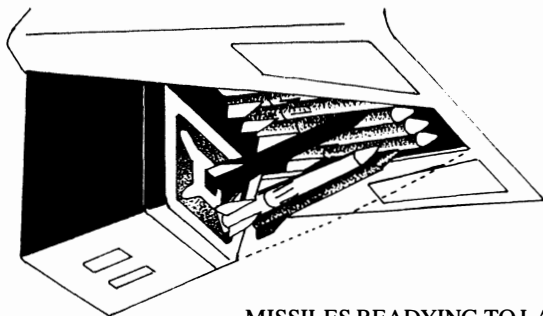

SIDE VIEW

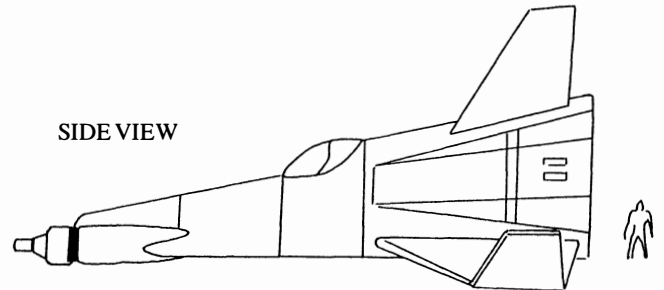

Speed: Approximately 4020mph or Mach 6 maximum; Mach 2.5 is usually the cruising speed.

Range: 10,000 miles (16,909km)

Height: 24ft (7.5m)

Width: 66ft (20.1m)

Length: 54ft (16.4m)

Weight: 40 tons

Engine: Nuclear Fusion Reactor

Bonuses: +1 to strike with auto-cannon, +2 to dodge.

Weapon Systems

1. Rapid Fire Ion Cannon mounted in the front, left side of the nose.

Primary Purpose: Anti-Aircraft

Range: 8000ft (2400m)

Mega-Damage: 1D6 x 10 M.D.

Rate of Fire: 4 per melee

Payload: Unlimited

2. 27 Medium Range Missiles can be launched.

Primary Purpose: Anti-Air/Space Craft

Range: Varies

Mega-Damage: Varies

Rate of Fire: Volleys of 3, 6 or 9. Remember, one volley counts as an attack, regardless of the number of missiles in the volley.

Payload: 27 total missiles; 9 stored in each of the 3 missile bays.

SPECIAL EQUIPMENT

1. Radar can identify and track up to 50 targets within a 100 mile range.

2. Targeting Computer: +1 to strike with Ion Cannon.

3. Ejection/Parachute System: Ejects the pilot's compartment.

4. Emergency Oxygen Supply: 6 hours.

SPECTER JET INTERCEPTOR

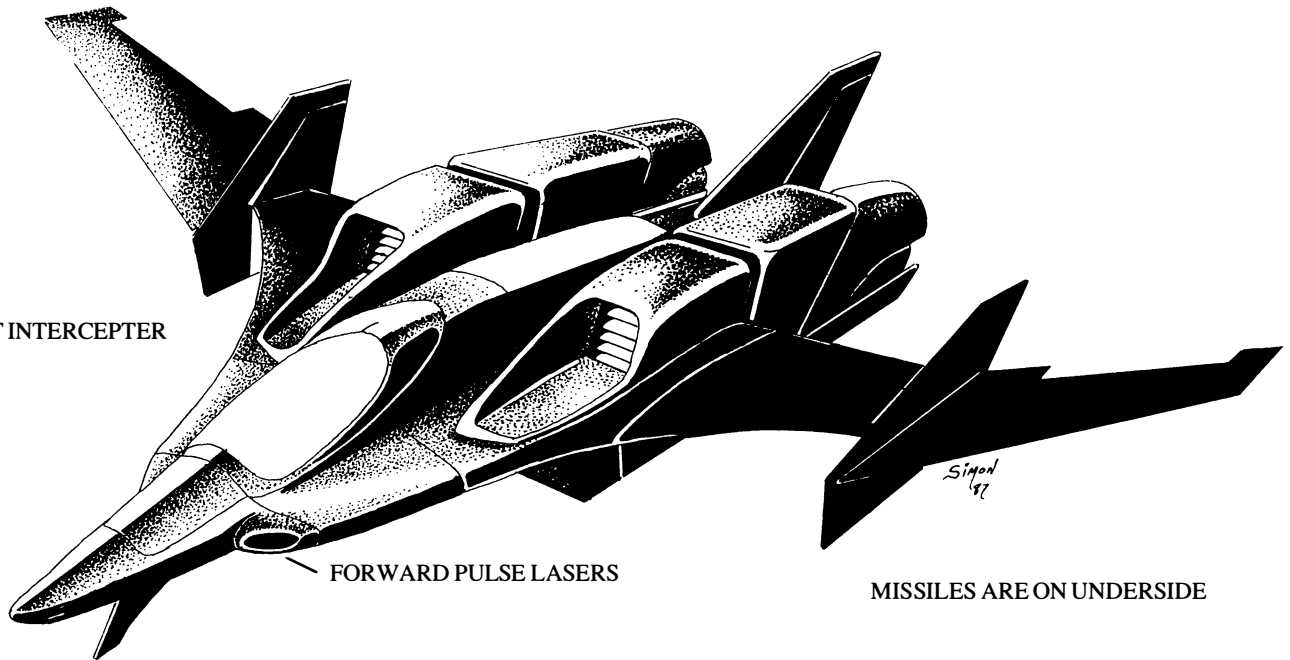

FORWARD PULSE LASERS

MISSILES ARE ON UNDERSIDE

SPECTOR JET INTERCEPTOR

The fastest jet in service is the Spector Interceptor. It is a small, highly maneuverable air and ground attack aircraft, armed with forward fixed lasers and heavy missiles.

Vehicle Type: Air/Jet Fighter

Crew: One; usually piloted by the T.A.F. or T.A.S.C.

M.D.C. by Location:

Forward Lasers (2) — 20 each

Twin Engines (2) — 75 each

Wings (2) — 75 each

Tail — 40

Reinforced Pilot's Compartment — 50

*Main Body — 150

*If all M.D.C. of the main body is depleted, the vehicle is destroyed. The pilot's only hope for survival is to eject and parachute to safety. Destroying a wing or engine will cripple the aircraft.

Speed: 2010mph or Mach 3 with a service ceiling of 50,000 feet and a bottom ceiling of 300ft (91.5m).

Range: 1800 miles (2896.2km)

Height: 16ft (4.9m)

Width: 40ft (12.2m)

Length: 42ft (12.8m)

Weight: 6.2 tons

Bonuses: +2 to strike, +4 to dodge

Weapon Systems

1. Two Rapid Fire, Pulse Lasers recessed on either side of the nose.

Primary Purpose: Anti Aircraft

Range: 4000ft (1200m)

Mega-Damage: 4D6 M.D. per pulse/blast

Rate of Fire: Six per melee (plus possible missile attack).

Payload: Unlimited

2. Four Medium or Long Range Missiles can be launched from the underside.

Primary Purpose: Anti-Aircraft

Range: Varies; both medium and long range can be launched.

Mega-Damage: Varies with missile type. Usually the most destructive types are used, such as high explosive heavy, fragmentation, armor piercing, plasma and proton torpedoes.

Rate of Fire: Two per melee. Missiles can be launched one at a time or in volleys of 2, 3 or 4.

Payload: Four

SPECIAL EQUIPMENT

1. Radar can identify and track up to 80 targets within a 200 mile range.

2. Targeting Computer

3. Ejection/Parachute System

4. Emergency Oxygen Supply: 6 hours

THE SPECTER RECON

The Spector Recon jet is a small, two man, reconnaissance vehicle that resembles a smaller, squat version of the *Spector Interceptor*. It is much slower, but is capable of flying 100ft (30m) above the ground at Mach 1. The aircraft is fitted with an aerial still camera and video camera system, which can film at a height of 20,000 feet. At 2000 feet the Spector Recon can engage a sophisticated sensor system that includes infrared and heat scans, random photo sequences and radio interception. The radar system can identify and track up to 100 individual targets simultaneously and detect a cruise missile-type target flying below 200ft (60m), while the Spector Recon itself is flying 20,000ft (6000m) at a range of 30 miles (48.2km).

Vehicle Type: Air/Jet Recon

Crew: Two; usually piloted by the T.A.F., Recon E.P. or T.A.S.C.

M.D.C. by Location:

Wings (2) — 50 each

Tail — 40

Twin Engines (2) — 50 each

Reinforced Pilot's Compartment — 50

*Main Body — 80

*If all the M.D.C. of the main body is depleted, the vehicle is destroyed.

Speed: Cruising 300mph (482kmph), 670mph or Mach 1, maximum, with a service ceiling of 40,000ft (12,192m).

Range: 1000 miles (1609km)

Height: 10ft (3m)

Width: 30ft (9.1m)

Length: 35ft (10.7m)

Weight: 5.6 tons

Bonuses: +2 to dodge

Weapon Systems: None

PHANTOM FIGHTER

The all weather jet interceptor, Phantom Fighter, is the second most common aircraft in the Southern Cross.

Vehicle Type: Air/Jet Fighter

Crew: One; usually piloted by the T.A.F. or T.A.S.C.

M.D.C. by Location:

Forward Auto Cannon — 20

Twin Engines (2) — 75 each

Wings (2) — 75 each

Tail — 40

Reinforced Pilot's Compartment — 50

*Main Body — 140

*If all the M.D.C. of the main body is depleted, the vehicle is destroyed. The pilot's only hope for survival is to eject and parachute to safety. Destroying a wing or engine will cripple the aircraft.

Speed: 1675mph or Mach 2.5 with a service ceiling of 60,000 feet and a bottom ceiling of 1000 feet (300m).

Range: 1000 miles (1609km).

Height: 17.6ft (5.3m)

Width: 36ft (11m)

Length: 62ft (18.9m)

Weight: 10 tons, fully loaded.

Bonuses: +1 to strike, +3 to dodge.

Weapon Systems

1. **Auto Cannon** built into the nose of the fighter.

Primary Purpose: Anti-Aircraft

Range: 2000ft (600m)

Mega-Damage: 2D6 per burst

Rate of Fire: Four per melee (plus missile attack).

Payload: 40 bursts

2. **Missile Bay** located in the underbelly of the fighter.

Primary Purpose: Anti-Aircraft

Range: Varies; either short or medium range missiles can be fired.

Mega-Damage: Varies with missile type.

Rate of Fire: Two attacks per melee, in addition to auto cannon attacks.

Fires volleys of 2 or 4.

Payload: 20 short range guided missiles or 10 medium range.

SPECIAL EQUIPMENT

1. Radar can identify and track up to 80 targets within a 200 mile range.

2. Targeting Computer

3. Ejection/Parachute System

4. Emergency Oxygen Supply: 6 hours

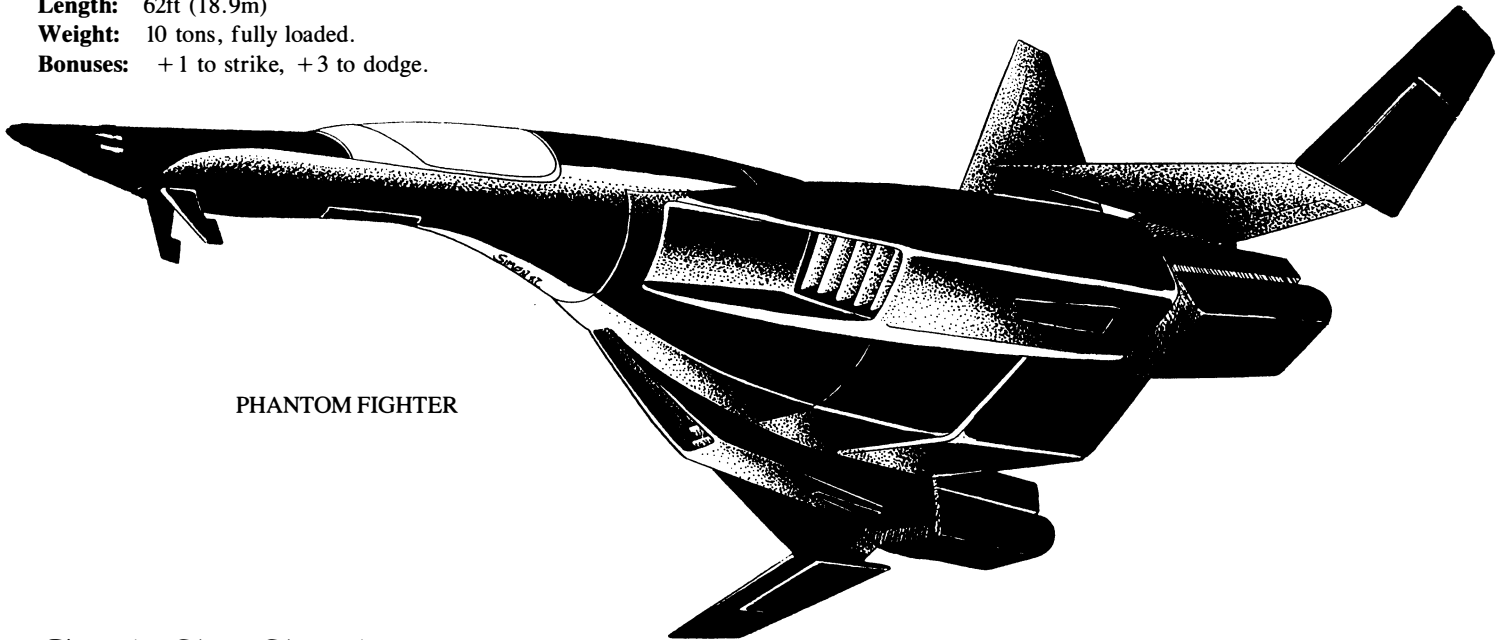

PHANTOM FIGHTER

SPACECRAFT

ASSAULT SHUTTLE

There are three major types of combat space shuttle craft, the smallest of which is the T.A.C.S. Assault Shuttle. Its primary purpose is transport, reconnaissance, and support in combat. The shuttle is armed with four heavy laser turrets, and can carry mecha troops, such as the AJACS Attack Copter, Logan Veritech or Hover Tank.

Vehicle Type: Ground Launched Combat Space Shuttle

Crew: 7; Pilot, Co-pilot, navigator and 4 gunners. Can also carry 32 troops and 8 mecha.

M.D.C. by Location:

Laser Turrets (4) — 200 each

Forward Lasers (2) — 100 each

Engines (rear section) — 500

Reinforced Pilot's Compartment — 250

Reinforced Passenger Compartment — 200

*Main Body (hull) — 100 per every 30 sq. ft.

*Total Main Body — 4000

Tail Fins (3) — 100 each

Cargo Hatch (bottom) — 100

*Depleting the M.D.C. of a 30 square foot area of the hull will punch a 30 foot hole in the spacecraft. The pilot and passenger areas have additional reinforced protection.

Depleting the M.D.C. of the entire spacecraft, 4000 M.D.C., will wreck it and set it adrift. If the pilot and crew compartments are left intact the personnel may survive (18 hour emergency oxygen supply). Destruction of the engines will set the craft adrift, but all systems function as normal. Destroying the tail fins have no effect in space.

Speed: 500mph (804.50kmph) — cruising speed, 2010mph/Mach 3 — maximum. Like all shuttles it needs booster rockets to launch it into space, but can reenter the atmosphere and land under it's own power.

Range: 60,000 miles

Height: 60ft (18.3m)
Width: 60ft (18.3m)
Length: 204ft (62.1m)
Weight: 150 tons
Cargo Capacity: 200 tons
Bonuses: +1 to strike with lasers, +6 to dodge.

Weapon Systems

1. **Rapid-Fire Laser Turrets** are mounted on the top, bottom and two sides, for a total of four. Each is operated by a gunner from within the shuttle. The +1 strike bonus is added to the gunner hand to hand bonus to strike (if any). 360 degree rotation with a 180 degree arc of fire.

Primary Purpose: Assault/Defense

Range: 8000ft (2400m)

Mega-Damage: 2D8 × 10

Rate of Fire: Six per melee, per EACH turret.

Payload: Unlimited

2. **Forward Lasers** are built into the nose of the shuttle and can be fired by the pilot, co-pilot or navigator.

Primary Purpose: Assault/Defense

Range: 4000ft (1200m)

Mega-Damage: 1D4 × 10

Rate of Fire: Four per melee

Payload: Unlimited

3. **Optional use** of any of the three Veritech mecha or battloids. *See Mecha section for details.*

SPECIAL EQUIPMENT

1. Radar can identify and track up to 70 individual targets, simultaneously, within a 100 mile range.
2. Targeting Computer
3. Long Range, Directional Laser Communication
4. Bomb bay style cargo doors in the belly of the vessel at midship.
5. Emergency Oxygen: 18 hour supply.

Note: This shuttle is first seen in episode #40 of the Robotech T.V. series.

C.T.C. COMBAT TROOP CARRIER SHUTTLE

The next largest space shuttle is the troop carrier. This vessel can easily carry an entire squadron of mecha, approximately 12 to 24 units, in addition to 56 to 72 troops. The C.T.C. Shuttle is designed as a frontline combat unit, with greater armor, laser turrets and missile launchers.

Vehicle Type: Ground Launched, Combat Space Shuttle

Crew: 17; pilot, 2 co-pilots, 2 navigators, 2 engineers, 2 communications, 8 gunners. Can carry up to 72 troops and 24 mecha (usually Veritech, especially the AJACS).

M.D.C. by Location:

Laser Turrets (4) — 200 each
Missile Turrets (4) — 200 each
Forward Lasers (2) — 100 each
Engines (rear section) — 1000
Reinforced Pilot's Compartment — 400
Reinforced Passenger Compartment — 300
*Main Body (hull) — 150 per every 30 sq. ft.
*Total Main Body — 8000
Cargo Hatch (bottom) — 200
Small Hatches (8) — 80 each
Tail Fins (3) — 100 each

*Depleting the M.D.C. of a 30 square foot area of the hull will punch a 30 foot hole in the spacecraft. The pilot and passenger areas have additional reinforced protection.

Depleting the M.D.C. of the entire spacecraft, 4000 M.D.C., will wreck it and set it adrift. If the pilot and crew compartments are left intact, the personnel may survive (18 hour emergency oxygen supply). Destruction of the engines will set the craft adrift, but all systems function as normal. Destroying the tail fins has no effect in space.

Speed: 400mph (643.60kmph) — cruising speed 2140mph/Mach 3.2 — maximum.

Range: 60,000 miles

Height: 120ft (36.5m)

Width: 120ft (36.5m)

Length: 403ft (122.8m)

Weight: 390 tons

Cargo Capacity: 410 tons

Bonuses: +1 to strike with lasers, +3 to dodge.

Weapon Systems

1. **Rapid-Fire Laser Turrets (4)** are mounted on the top, bottom and two sides, for a total of four. Each is operated by a gunner from within the shuttle. The +1 strike bonus is added to the gunner's hand to hand bonus to strike (if any). 360 degree rotation with a 180 degree arc of fire.

Primary Purpose: Assault/Defense

Range: 8000ft (2400m)

Mega-Damage: 2D8 × 10

Rate of Fire: Six per melee, per EACH turret.

Payload: Unlimited

2. **Forward Lasers (2)** are built into the nose of the shuttle and can be fired by the pilot, co-pilot or navigator.

Primary Purpose: Assault/Defense

Range: 4000ft (1200m)

Mega-Damage: 1D4 × 10

Rate of Fire: Four per melee

Payload: Unlimited

3. **Missile Launcher Turrets (4)** are mounted on the top, bottom and both sides of the shuttle. Like the laser turrets, they are fired by a gunner within the vessel. Each turret can rotate 360 degrees, with a 90 degree arc of fire. The +1 strike bonus does NOT apply to missiles.

Primary Purpose: Anti-Spacecraft

Range: Varies

Mega-Damage: Varies with missile type. Usually the most destructive, such as plasma and high explosive heavy are used.

Rate of Fire: Each turret can fire one at a time, or a volley of 2 or 3.

Payload: Each turret contains *six missiles*, but can descend below the hull for automatic reload. Reload requires one melee. Each turret can be reloaded eight times (plus the original six missiles), for a total of 54 missiles per EACH turret.

4. **Optional use** of any of the three Veritech mecha or battloids. *See mecha section for details.*

SPECIAL EQUIPMENT

1. Radar can identify and track up to 70 individual targets, simultaneously, within a 100 mile range.
2. Targeting Computer
3. Long Range, Directional, Laser Communication.
4. Bomb bay style cargo doors in the belly of the vessel at midship.
5. Emergency Oxygen: 18 hour supply.

D.S.S. DEFENDER SPACE SHUTTLE

The largest and most powerful of the three shuttle craft is the Defender. It is heavily armored, carries a complement of AJACS Veritech Attack Copters, and has a barrage of armaments. It is the core of the Southern Cross' space defense fleet.

Vehicle Type: Ground Launched, Combat Space Shuttle.

Crew: 47; pilot, 3 co-pilots, 2 navigators, 3 communications, 6 engineers, 16 gunners and 16 crew men. It can carry 144 troops, plus up to 48 mecha. Always has 12 AJACS Veritechs.

M.D.C. by Location:

- Laser Turrets (8) — 200 each
- Missile Turrets (8) — 200 each
- Forward Lasers (2) — 100 each
- *Engines (2) — 600 each
- Reinforced Pilot's Compartment — 400
- Reinforced Troop Compartment — 300
- **Main Body (hull) — 200 per every 30 sq. ft.
- **Total Main Body — 10,000
- Cargo Hatch (bottom) — 400
- Small Hatches (12) — 100 each

*Destroying one engine reduces speed and dodge by half.

*Depleting the M.D.C. of a 30 square foot area of the hull will punch a 30 foot hole in the spacecraft. The pilot and passenger areas have additional, reinforced protection.

Depleting the M.D.C. of the entire spacecraft, 10,000 M.D.C., will wreck it and set it adrift. If the pilot and crew compartments are left intact, the personnel may survive (18 hour emergency oxygen supply). Destruction of the engines will set the craft adrift, but all systems function as normal. Destroying the tail fins has no effect in space.

Speed: 600mph (965kmph) — cruising speed, 2560mph/Mach 3.8 — maximum

Range: 70,000 miles

Height: 200ft (61m)

Width: 245ft (74.7m)

Length: 940ft (286.5m)

Weight: 1250 tons

Cargo Capacity: 1000 tons

Bonuses: +1 to strike with lasers, +2 to dodge.

Weapon Systems

1. **Rapid-Fire Laser Turrets (8)** are mounted on the top, bottom and two sides, for a total of eight. Each is operated by a gunner from within the shuttle. The +1 strike bonus is added to the gunner's hand to hand bonus to strike (if any). 360 degree rotation with a 180 degree arc of fire.

Primary Purpose: Assault/Defense

Range: 8000ft (2400m)

Mega-Damage: 2D8 × 10

Rate of Fire: Six per melee, per EACH turret.

Payload: Unlimited

2. **Forward Lasers (2)** are built into the nose of the shuttle and can be fired by the pilot, co-pilot or navigator.

Primary Purpose: Assault/Defense

Range: 4000ft (1200m)

Mega-Damage: 1D4 × 10

Rate of Fire: Four per melee

Payload: Unlimited

3. **Missile Launcher Turrets (8)** are mounted on the top, bottom and both sides of the shuttle. Like the laser turrets, they are fired by a gunner within the vessel. Each turret can rotate 360 degrees, with a 90 degree arc of fire. The +1 strike bonus does NOT apply

to missiles.

Primary Purpose: Anti-Spacecraft

Range: Varies

Mega-Damage: Varies with missile type. Usually the most destructive, such as plasma and high explosive heavy are used.

Rate of Fire: Each turret can fire one at a time, or a volley of 2 or 3.

Payload: Each turret contains *six missiles*, but can descend below the hull for automatic reload. Reload requires one melee. Each turret can be reloaded eight times (plus the original six missiles), for a total of 54 missiles per EACH turret.

4. **12 AJACS Veritech Attack 'Copters** are the standard mecha complement. 2 to 6 space battloids are also common. A total of 48 mecha can be carried. *See mecha section for data on the AJACS and others.*

WEAPONS & EQUIPMENT

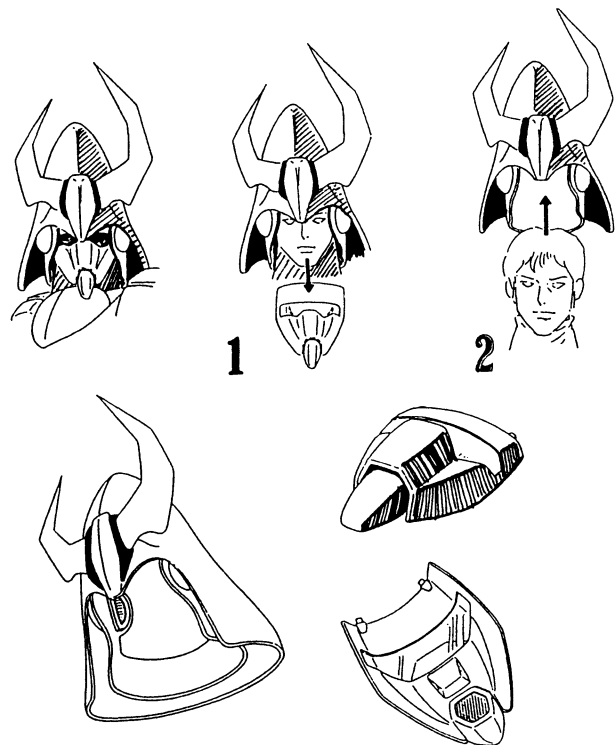

BODY ARMOR OF THE SOUTHERN CROSS

The combat armor of the Southern Cross is a durable, lightweight blend of new metal alloys and laser resistant ceramics. Each of the fifteen Armies has its own distinctive style of armor. Within each of the fifteen branches, the commissioned officers with its crests, peaks and detailing; the low ranking, non-commissioned officer with his/her less ornate helmet, and the basic, drab, grunt armor.

Despite stylistic differences, all of the body armors have the same basic properties.

1. M.D.C. 50 and laser resistant (lasers do ½ damage).
2. Complete Environmental Battle Armor (E.B.A.) suitable for use in space and other hostile environments.
3. Computer controlled life support system.
4. Internal cooling and temperature control.
5. Humidifier.
6. Gas filtering and artificial circulation.

7. Independent oxygen supply and purge system which automatically engages in low oxygen or polluted environment. Six hour oxygen supply, maximum.
8. Insulated, high temperature resistant weave of nylon, synthetic fibers and metal mesh.
9. Fire resistant up to 300 degrees centigrade. Normal fires do no damage, but plasma and nuclear fire have full effect.
10. Radiation shielded.
11. Helmet with removable face plate.
12. Directional, short range radio built into the helmet. Range 4 miles (6.4km).
13. Computer enhanced optic system: infrared, ultraviolet and passive nightvision (light amplification). All have a range of about 120ft (36.6m).
14. Tinted, light sensitive visor.
15. Special back pack attachment. This can be a simple ceramic pack to carry food, water, and additional equipment or oxygen tank (adds six hours to oxygen supply); or jet pack for flight or maneuverability in space or underwater.
16. Utility belt/holster.

Some of the body armor have special features:

For example: The Tactical Armored Space Corp (TASC) has maneuvering jets built into the ankles, knees and back while the Mountain Squad (MoS) has a system of hooks and reinforced connectors for rope and pulley attachment. However, all have the properties previously described.

BODY ARMOR ACCESSORIES

BACK PACKS

The most impressive accessory is the different back packs which can be instantly and snugly attached to the body armor. All back packs are as tough as the body armor.

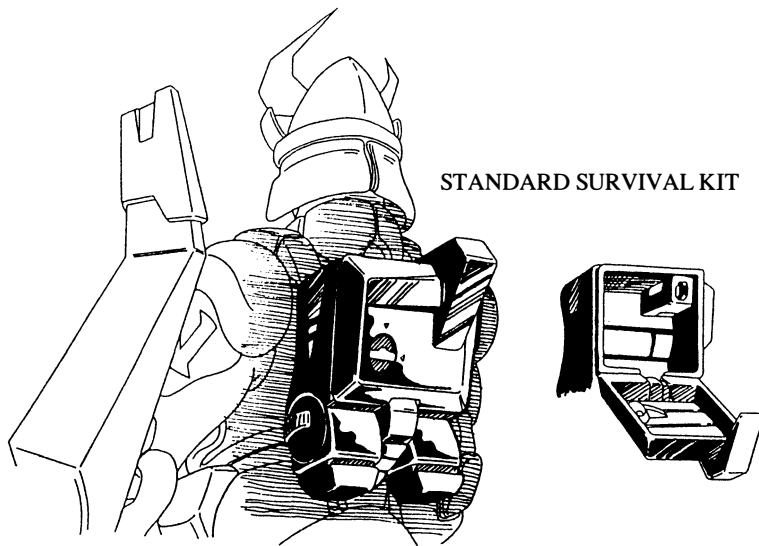

STANDARD SURVIVAL KIT: The main compartment is locked with an individual, combination-type lock mechanism. The pack usually contains a first-aid kit, pocket knife, matches or lighter, flashlight, vitamins and three weeks worth of freeze-dried foods. Suspended from the bottom of the survival kit are two detachable water containers. Each water jug can hold three quarts of water (a total of 1½ gallons or 5.7 liters).

Approximate Weight: 20 pounds (9.1kg) — fully loaded.

M.D.C. of Back Pack: 10

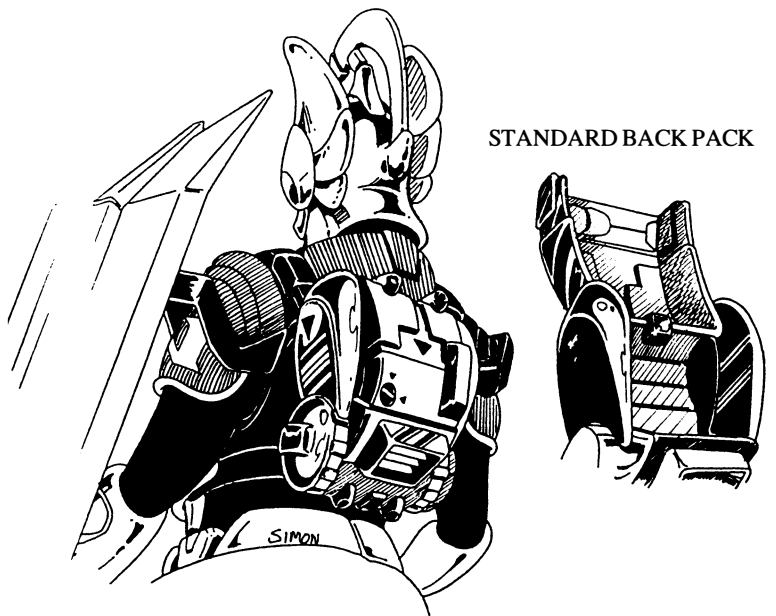

STANDARD BACK PACK: This pack has one large, locking compartment for holding equipment and supplies, whether it be additional ammunition, grenades, tools, food, optics, etc. Two flares and a lighter come with the pack. At the bottom of the back pack is a detachable cylinder which can be used to hold a gallon of water, or emptied and sealed airtight as a specimen container.

Approximate Weight: 30 pounds (13.61kg) — fully loaded.

M.D.C. of the Back Pack: 10

Note: This pack is commonly used by all branches of the Southern Cross.

EXTRA OXYGEN TANKS: A sturdy, lightweight, air tank pack that provides an additional 6 hours of air.

Approximate Weight: 30 pounds (13.61kg).

M.D.C. of Back Pack: 15

SPACE BOOSTER PACK: A jet pack attachment for flight in space is standard issue for the Cosmic Unit and Tactical Armored Space Corp.

Approximate Weight: 70 pounds (31.75kg).

M.D.C. of Back Pack: 25

Speed: 100mph (160kmph) in space. Not suitable for flight in an atmosphere, but it is acceptable for underwater use; 30mph (48kmph) — maximum.

Duration: Six hours of continual use before fuel is depleted.

Bonuses: +1 to dodge in space or underwater.

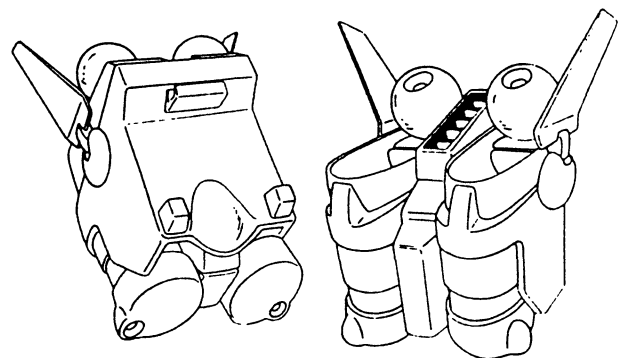

SPACE BOOSTER PACK

JET PACK: A small jet pack capable of sustained flight in an atmosphere is standard issue for the Tactical Air Force and Civil Defense Flying Corp. It is also commonly used by the TASC and GMP.

Approximate Weight: 57 pounds (25.88kg).

M.D.C. of the Back Pack: 25

Speed: 60mph (95kmph) in an atmosphere; 80mph (128kmph) in space. It is not suitable for underwater travel.

Duration: Approximately two hours of use, with an effective range of 340 miles. Maximum altitude is 2000 feet (609m).

Bonuses: +1 to dodge when flying.

Note: With proper authorization, any of the fifteen Armies can use any of the back packs and other accessories.

THE COLD WEATHER UTILITY BELT is unique in several respects. Mounted into the massive buckle compartment is a searchlight that can emit visible and infrared light; range: 60ft (18.3m). Even more unique is the temperature controlled compartments to prevent the freezing of items and equipment. Two large compartments are located near the hips, with two others along the back.

THE HOT WEATHER UTILITY BELT is standard issue for the Desert and Jungle Squads. Like the cold weather belt, it has temperature controlled compartments along the hips and back. These airtight, oval compartments are slightly refrigerated to prevent spoilage of food and specimens, as well as to prevent mildew and other, heat related problems. A refrigerated canteen unit can also be attached.

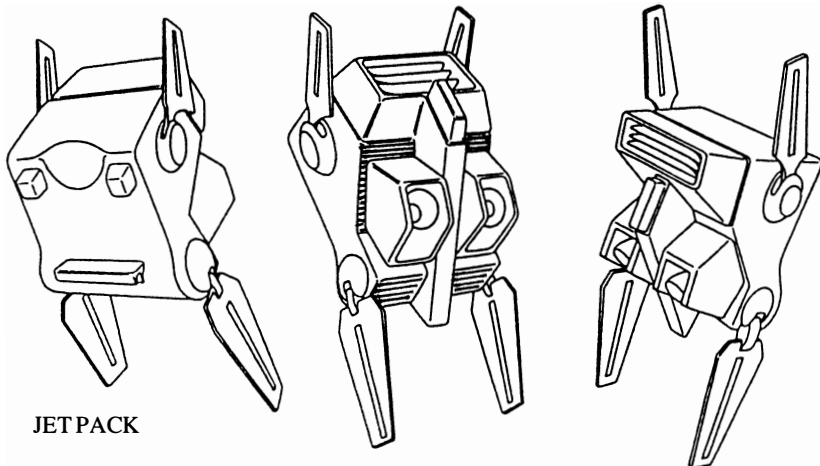

JET PACK

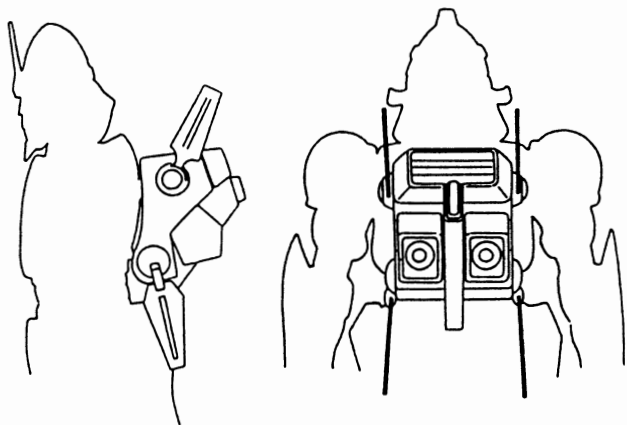

T.A.S.C. FROM BACK VIEW
SHOWING JET PACK ATTACHMENT MOUNTS.

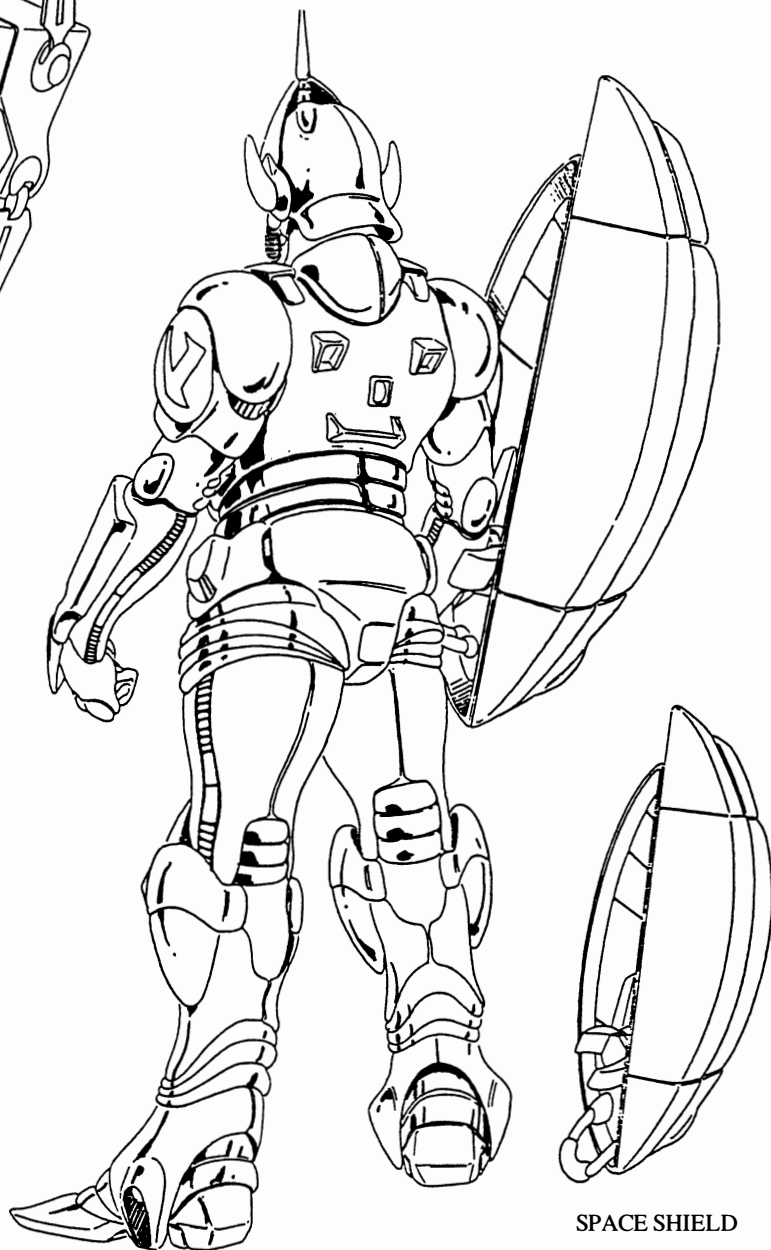

SPACE SHIELD

UTILITY BELTS

The Standard Utility Belt is used by all branches of the military. It is a large, baggy, holster type unit, with pouches on both hips and one larger pouch on the back. Each hip pouch usually contains two to four additional ammunition clips for handguns or rifles. The back pouch can contain almost anything: more ammo, flares, food packets, etc. On the right hip, is also a detachable holster for a handgun. This standard unit is often seen worn by the Tactical Corp and Global Military Police.

THE HEAVY UTILITY BELT is also used by all branches of the military, but particularly by the Alpha Tactical Armored Corp, Recon Escort Patrol and Civil Defense Unit. Generally, it is larger than the standard belt. The two side pouches can hold six to eight ammo-clips and in addition to the large back pouch, there is a large buckle compartment in the front. A detachable holster for a handgun can attach on the right or left hip.

THE SPACE UTILITY BELT is basically identical to its ground based counter parts except that it has pouches that tuck and seal under the belt. This belt is exclusive to the Cosmic Unit and Tactical Armored Space Corp.

SHIELDS

The inclusion of *laser resistant shields* is an excellent addition to the body armor, providing the soldier with greater protection and combat versatility. The fighting man can actually *parry* or block projectile and energy attacks with the shield.

RPG NOTE: In a game context, this new parry option functions *exactly* as usual. The attacker rolls one 20 sided die to strike, and the defender can try to parry the blast or bullet with his shield by rolling a 20 sided die. The defender's roll must equal or surpass his attacker's roll to successfully parry the attack. **If successful**, the shield takes ALL damage. **If not successful**, the parry misses and the blast hits the body (or specific body area, if a called shot). Damage is then subtracted and combat continues. **Note:** The shield is *useless* against area effect weapons, such as missiles, grenades and other explosives.

SHIELD TYPES AND CHARACTERISTICS

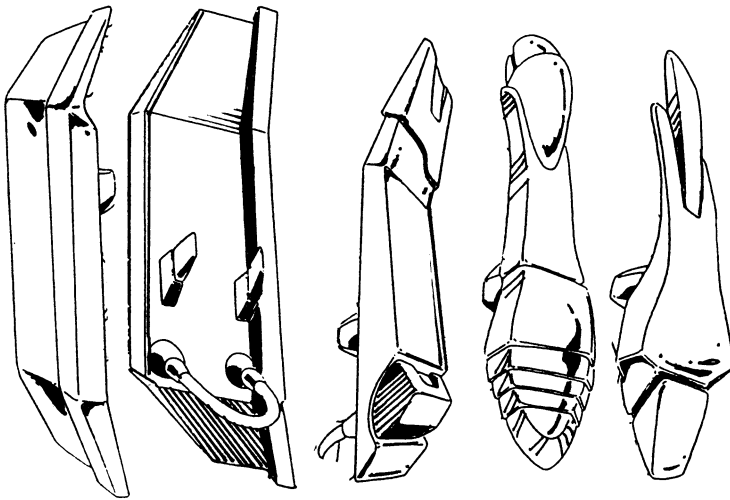

HEAVY COMBAT SHIELD: Designed with hand to hand and field combat in mind. This variety of shield is used by the *Global Military Police, Tactic Corp, Alpha Tactical Armored Corp, Cold Weather Offensive Squad, Humid Climate Offensive Squad and Civil Defense Unit.*

M.D.C. of the Shield: 100

Damage: 2D6 S.D.C. (not M.D.C.) when used as a hand held weapon/bludgeon.

Bonuses: +1 to parry



LIGHT COMBAT SHIELD: A small shield designed to allow maximum hand movement for pilots. It affords minimal protection, but can still be used as an effective parrying and offensive weapon in hand to hand conflict. This variety of shield is used by the *Tactical Air Force, Recon Escort Patrol and Civil Defense Flying Corp.*

M.D.C. of the Shield: 40

Damage: 1D6 S.D.C. (not M.D.C.) when used as a hand held weapon/bludgeon.

Bonuses: None

SPACE SHIELDS

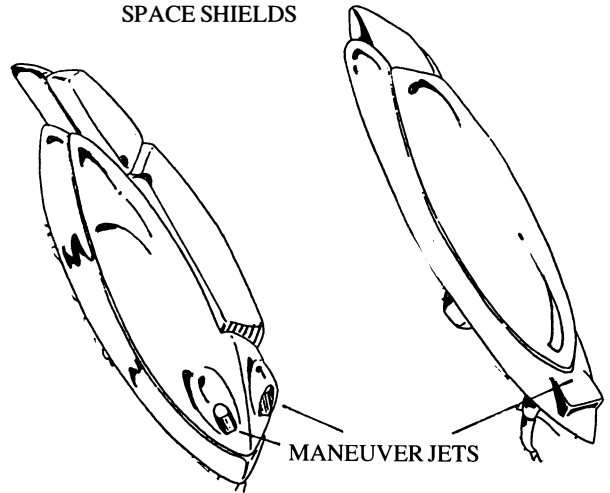

SPACE SHIELD: Air jets built into these shields, for additional mobility in space, distinguish them from the other types. Two shields of this variety are used by the *Cosmic Unit and Tactical Armored Space Corp.*

M.D.C. of the Shield: 80

Damage: 1D6 S.D.C. (not M.D.C.) when used as a hand held weapon/bludgeon.

Bonuses: +1 to dodge in outerspace only, because of the jets.

Damage: 1D6 S.D.C. (not M.D.C.) when used as a hand held weapon/bludgeon.

Bonuses: None

SEARCHLIGHT SHIELDS: *The Desert Squad and Jungle Squad* both have shields with a small, high intensity searchlight built into it. The beam has an 180ft range (54.9m) and can emit visible or infrared light.

M.D.C. of the Shield: 60

SEARCHLIGHT SHIELD 3 VIEWS

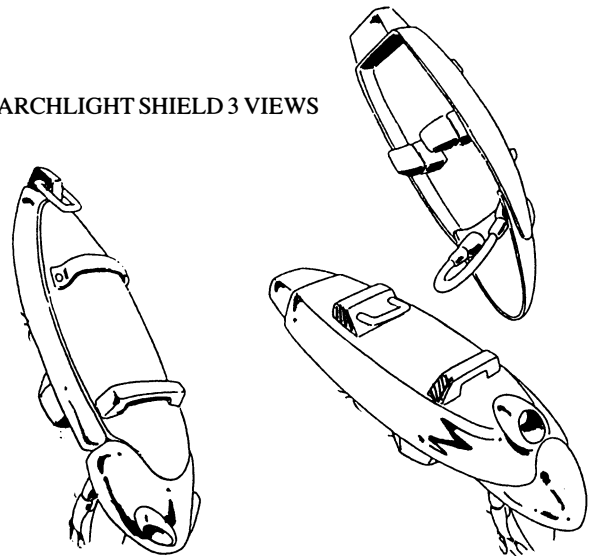

NO SHIELDS: Only the *Mountain Offensive Squad and Seq Squad* do not use shields. In both cases, the need for maximum manual dexterity is required, preventing the use of a shield. However, a shield can be used if one is available and the circumstance allows it.

WEAPONS

The advent of laser technology introduced a whole new age of *handguns*. The intensified light beams could travel farther distances and at greater velocity than any conventional, projectile firing weapons. With diffusion through the atmosphere, a laser beam had a limited range. Even when fired by a larger, rifle-type weapon, the improved distance and power of the laser was negligible. Only the big, heavy laser weapons built into the mecha and aircraft had significantly improved distance. What this all means is that a laser system could be built into a handgun/pistol that nearly equalled the range of a conventional rifle. The advantage of this meant small lightweight guns, with the distance of a rifle, that could be fired with one hand. Truly a revolution in handguns. The number of laser/energy handguns in the Army of the Southern Cross reflects the success of this breakthrough.

Most of these weapons do devastating amounts of damage (mega-damage). Thus, they can not be regarded as simple energy versions of conventional handguns. Remember, one mega-damage point is equal to 100 S.D.C. You will notice that most of these weapons do greater damage at close range. This is because the laser or energy beam is less diffused and at greater strength when traveling shorter distances. It has also been discovered that energy pulses (short, concentrated blasts) are more effective and energy efficient than long beams. Pulse weapons will always have a greater payload. All weapons have energy clips or "E-Clips" as they are commonly called.

HANDGUNS

THE PPL-12 PANTHER PULSE LASER is a light weight precision laser pistol which has become the *standard* weapon of the Southern Cross Armies. **Weight:** 4½lbs (2kg). **Effective Range:** 1200ft (366m); **Damage:** 1D6 M.D. per blast. **Cost:** 2000 credits. **Feed:** 12 shots per E-Clip.

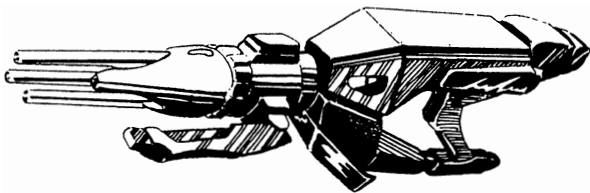

THE TRI-LASER is the *Tactical Corp's* favored weapon. This powerful, rapid-fire pulse laser can be fired one handed, or held with two hands by a retractable handgrip, for greater stability. **Weight:** 6½lbs (2.9kg). **Effective Range:** 800ft (244m). **Damage:** 3D6M.D. per triple blast (fires three simultaneous pulses; one from each barrel). **Cost:** 3600 credits. **Feed:** 10 triple blasts per E-Clip.

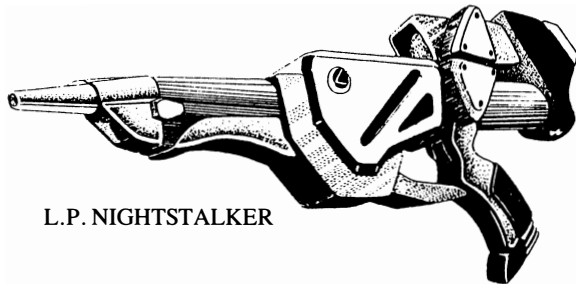

L.P. NIGHTSTALKER

THE L.P. NIGHTSTALKER is a high powered laser pistol with a built-in, telescopic, passive, light amplifying optic system. **Note:** Some sort of light must be available for the system to work. A totally pitch-black room/tunnel will render the optics useless. However, it is particularly excellent outdoors. This weapon is the favorite of the *G.M.P.*, *Jungle Squad* and *Recon Escort Patrol*. **Weight:** 5lbs (2.3kg), **Effective Range:** 1200ft (366m), **Damage:** 1D4 M.D. at 610 to 1200ft, 2D4 M.D. at 600ft (183m) or less. **Cost:** 3200 credits. **Feed:** 20 blasts per E-Clip.

P-20 PULSE LASER

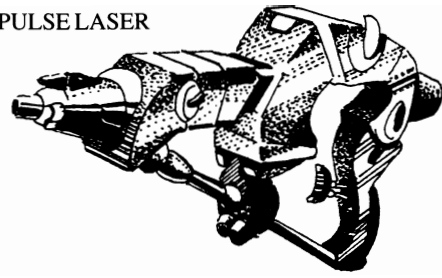

THE P-20 PULSE LASER is a very light handgun preferred by the *TASC*, *TAF*, *MOS*, and *CDFC*. **Weight:** 4lbs (1.8kg), **Effective Range:** 1200ft (366m), **Damage:** 1D6 M.D. per blast. **Cost:** 2000 credits. **Feed:** 20 shots per E-Clip.



THE LANCER LASER PISTOL is the oldest model laser pistol still in service. It is used exclusively by both branches of the Civil Defense. **Weight:** 8lbs (3.6kg), **Effective Range:** 1000ft (300m), **Damage:** 1D4 M.D. at 610 to 1000ft, 2D4 at 600ft (184m) or less. **Cost:** 1200 credits. **Feed:** 12 blasts per E-Clip.

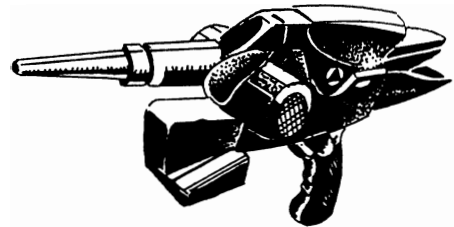

THE RFL-100 RAPID-FIRE PULSE LASER is an incredible weapon that can fire individual blasts, or shoot in a burst or spray like a machinegun (same combat rules apply). This heavy weapon is reserved for the most deadly situations and only upon authorization. **Weight:** 12lbs (5.4kg), **Effective Range:** 800ft (244m), **Damage:** 1D6 M.D. per individual blast (up to 10 blasts can be fired per melee as aimed shots) or fired in *bursts*. Use the same rules as *machinegun* under the Modern Weapon Proficiencies section, page 30, in the *ROBOTECH™* RPG. **Cost:** 15,000 credits. **Feed:** 100 shots per E-Clip.

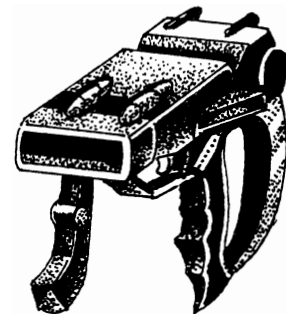

THE ID-4 ION DISRUPTER is a non-laser energy weapon that fires a wide energy bolt. Although the range and feed is limited, it does massive damage. **Weight:** 6lbs (2.7kg), **Effective Range:** 400ft (122m), **Damage:** 4D6 M.D. **Cost:** 10,000 credits. **Feed:** 4 shots per E-Clip.



THE ROBOTECH MASTERS

THE PUTMAN STUN-GUN fires an energy charge that short-circuits the nervous system. **Effects:** There is a 60% chance of rendering its victim unconscious. Even if still conscious, the person will be dazed: - 10 to strike, parry and dodge for 2D4 melees.

Savings Throw: Because people are different, some can fight off the effects of a stun blast. Roll to save vs toxin (14 or higher) against each blast. A *successful save* means that blast had no debilitating effect other than giving you a splitting headache and a nauseated feeling.

This weapon is a favorite of the two Civil Defense Corps, and commonly used by the G.M.P., and R.E.P. **Weight:** 1lb (.5kg), **Effective Range:** 200ft (61m), **Damage:** Stun. **Cost:** 1500 credits. **Feed:** 6 blasts per E-Clip. **Important Note:** The body armor of the Southern Cross provides excellent protection against stun attacks, absorbing most of the blast and providing a *bonus of +10 to save*.

RIFLES

THE LR-20 LASER RIFLE, with a telescopic, thermo-imager sight, is the main frontline combat rifle. It is a favorite of the Tactical Corp, ATAC and REP, as well as, common use by most of the other armies. **Weight:** 8lbs (3.6kg), **Effective Range:** 2000ft (600m), **Damage:** 1D6 M.D. at 1000 to 2000ft, 2D6 at 999ft (348m) or less. **Cost:** 5600 credits. **Feed:** 20 blasts per E-Clip.

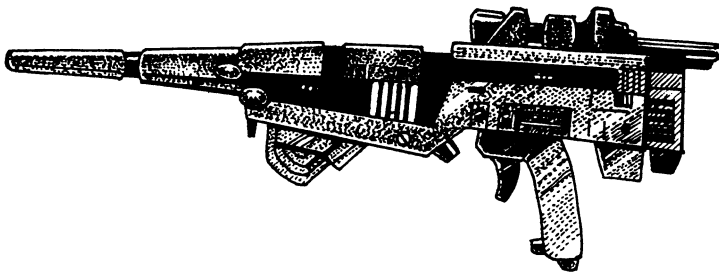

THE PR-30 PULSE RIFLE is the heavy assault rifle of the armed forces and standard issue to the ATAC and TASC. **Weight:** 8lbs (3.6kg), **Effective Range:** 1400ft (427m). **Damage:** 2D6 M.D. per blast. **Cost:** 6000 credits. **Feed:** 30 shots per E-Clip.

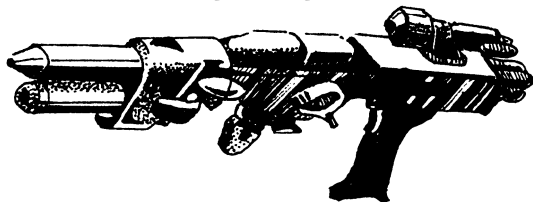

THE LR-30 LASER ASSAULT RIFLE is the main, light assault weapon of the armed forces. **Weight:** 9lbs (4.1kg), **Effective Range:** 1400ft (427m). **Damage:** 1D6 M.D. at 800 to 1400ft, 2D6 M.D. at 790ft or less. **Cost:** 5400 credits. **Feed:** 30 shots per E-Clip.

Note: *The time required to change an E-Clip is one melee (15 seconds).* 2. All weapons can be assigned to any member of the Armies of the Southern Cross. However, some weapons are standard issue, or more commonly used by one Army or another.

MISCELLANEOUS . . .

THE COBALT GRENADE: **Weight:** ½lb (0.2kg), **Effective Throwing Range:** 90ft (27.4m), **Damage:** 1D6 M.D. **Blast Area:** 12ft (3.6m). **Cost:** 500 credits. Available to all armies except Civil Defense.

The RDFs energy weapons and conventional projectile weapons are still used, especially by third world countries, rebels and terrorists. See listings on pages 77-79 of the ROBOTECH® RPG.

For eons, the race of beings known as the Robotech Masters have dominated the universe. Exactly how long is unknown. Where they came from, how they rose to power, and what motivates them are mysteries we will try to unravel.

The Robotech Masters' homeworld can be found in a four star, planetary system in a distant galaxy. On Earth, the constellation is visible only from the Southern Hemisphere, hence its name — "The Southern Cross". Above the largest planet in this system is the moon of Fantoma. While life originated on the planet, Tyrol, it is on Fantoma, its moon, that the seat of science and technology developed. The race of beings, generically called the Robotech Masters, developed into a thriving society. Yet, it was not until the scientist, Zor's discovery of protoculture did the Robotech Masters gain their name and reputation as "techno-wizards".

The discovery and development of protoculture rocketed the Masters light-years ahead of the other intelligent life forms in the area. Protoculture was derived from the Invid Flower of Life; a bizarre alien plant with almost mystic properties. The development of protoculture technology produced three overwhelmingly significant results: 1) First and foremost, one properly germinated seed, locked in stasis, would give off energy a 1000 times greater than the best nuclear reactor. A special system of batteries and generators could tap into the energy created by this organic power-plant and draw on its energy for years. A handful of seeds could power a planet. 2) When this organic power source is combined with machines, it imparts an almost living quality. This would lead to the development of Robotechnology and the unique synthesis of man and machine. 3) Protoculture can be used to develop clones. It was through protoculture genetic manipulation that the Zentraedi and bioroid clones were created.

The Robotech Masters were quick to utilize protoculture to its fullest. First they had Zor collect up all the germinated seeds, store them, and destroy the original plants. The result was the complete defoliation of the Invid homeworld. An act of greed that would unleash the Invid on the universe and lead to the Robotech Masters' destruction. Next they began to sell their technological wonders to other worlds, seeing to it that they would become technologically dependent on them. As the Robotechnology developed the Masters became more arrogant and cruel. Entire worlds were dependent upon them for energy and tiny smatterings of Robotechnology. Without the plant itself, no other culture could unravel its mysteries. A seed used to generate power is irreparably damaged and can only be used as an energy source, nothing more. It seemed the Robotech Masters, alone, held the greatest power in the universe. Even the appearance of the enigmatic Invid, which would signal the beginning of a war that would stretch into eons, did not sway the Robotech Masters.

It is said that with ultimate power comes ultimate corruption. An axiom that became all too true for the Robotech Masters. The creation of clones meant immortality for the Robotech Masters. But, with each passing decade, they became more and more detached from their human roots, until they viewed all life as pawns in some twisted game only they understood. The selling and trading of Robotechnology was no longer satisfactory. If a planet refused to deal with the Masters they were threatened or blackmailed into submission. If a world still refused or dared to strike back, they were annihilated by the Zentraedi, the Robotech Masters' personal army. An army of giants that numbered into the thousands of millions and whose only joy was war.

Eventually, Zor, the discoverer of the Flower of Life and the father of Robotechnology, realized the evil that was being made of his crea-

tions. After several, futile attempts to stop the abuse of protoculture, he took action himself. Collecting all the germinated seeds (he was still head of protoculture development), he placed them on his newly designed battle fortress, the SDF-1, and blasted into space. His mission was to seed other worlds. Instead, he would destroy all data on protoculture except his own, and blackmail the Robotech Masters with the last supply of protoculture seeds hidden in the battle fortress. In this way, he was certain he could force the Masters into a more humane and equitable use of protoculture. As fate would have it, Zor would be killed, but not before he launched his battle fortress and last of the protoculture supply to a distant world, Earth. That fateful event would give the humans of Earth the secrets of protoculture and signal the destruction of the Robotech Masters' Society, and the mass genocide of nearly all of the Zentraedi.

It has been nearly three decades since Zor's ship crashed into our planet. The Robotech Masters' minions, the Zentraedi, came to reclaim the precious protoculture, laying waste to most of the Earth. Yet, at the end of the cataclysmic battle, four million Zentraedi warships were destroyed and the people of Earth stood triumphant. Fifteen years later, the Robotech Masters have come to take the protoculture for themselves. Their own supply is nearly exhausted. Unless they can replenish it they are doomed. Yet, in their arrogance, they still will not share and plan to take what they want, crushing whoever stands in their way. So begins the Second Robotech War.

THE ROBOTECH MASTERS

The Robotech Masters, themselves, are physically weak and, except for their machines and minions, defenseless. It is the "Masters" who are the driving force and true power behind their people. Unfortunately, they are a misguided force that has lost any vestiges of humanity long ago. The Masters are driven by greed and power. Nothing more. They understand fear, anger, hate, and compassion only as tools to be used to manipulate others. Love, friendship and true caring are forgotten, and as alien as the Invid.

Once great strategists, the Robotech Masters have lost that edge too. They are (were) so powerful that the only tactics they use are intimidation and raw force. Fear has always been their ultimate weapon, instilled by their Zentraedi warriors and vast armadas of ships, and fueled by technology that seemed to dwarf most others. But with the destruction of their Zentraedi and the loss of a protoculture supply, the Master's power base is gone, and their empire crumbles.

The Robotech Masters still command great power. The bioroids and technology at the disposal of their small, Earthbound, fleet is enough to lock our planet in global war. It is only the Earth people's tenacity, courage and own protoculture technology that enables them to engage the weakened Robotech Masters in a battle royal.

A TYPICAL ROBOTECH MASTER

Hit Points: 60 S.D.C.: 10

Alignment: Always Diabolic, Miscreant, or Anarchist

Attributes: I.Q. 20 + 1D6, M.E. 15 + 1D6, M.A. 20 + 1D6 (intimidation factor), P.S. 2D6, P.P. 2D6, P.E. 3D6, P.B. 2D4, Spd. 2D4

Age: Unknown. Through the use of cloning and mind transferal into a younger, healthier body, they are effectively immortal.

Weight: 150lbs **Height:** 6ft (1.8m)

Disposition: Super arrogant, cruel, maniacal, and cunning in the extreme. They view other intelligent life as their pawns in a game.

Rank: The ultimate power of their people.

Skills: They are strategists, tacticians, organizers and directors who do not concern themselves with any mundane labor or efforts. They see themselves as being on a higher plane and do not concern themselves with developing skills as we understand them. Consequently, they have surrounded themselves with people of their race, clones of the masters' own creating, who handle the daily chores and things such as skills.

Combat Abilities: One attack per melee; no parry, but dodges are automatic; +2 to dodge.

Psionic Abilities

The Robotech Masters all possess a limited degree of psionic abilities. None are effective weapons.

Levitation (self): The Master can psionically and effortlessly lift himself into the air. This is a natural state for the Robotech Masters. They can also move while levitated through telekinetics. **Range:** Self, up to 60ft (18.3m) high. **Duration:** Indefinite.

Limited Telekinesis: The ability to move physical objects or oneself through the power of thought. The Robotech Masters can move themselves at a slow, measured pace, as well as small, light objects. **Weight Limitation** on objects other than self is 6lbs (2.7kg). **Range:** 100ft (30.5m). **Duration:** Indefinitely.

Limited Telepathy: The Masters possess a sort of one-way telepathic ability. They can NOT read another person's thoughts, but can project their own. This is how the Robotech Masters communicate



among themselves. They will either use telepathy or speak the language to communicate with alien life. Range: 300ft (91.5m). Duration: Indefinite.

Limited Empathy: The Masters can sense the emotions (not thoughts) of those around them. Range: 90ft (27.4m). Duration: Indefinite.

Precognitive Awareness: A sort of sixth sense that will alert the psionic to any potential danger, traps, ambushes, etc. This always gives the Master's the initiative and a +4 bonus to dodge. Range: 90ft (27.4m) radius of awareness. Duration: Constant/indefinite.

Total Recall: The psionic is able to remember small blocks of information in absolute detail. The memory of the information recalled is retained for 20 minutes, then fades away unless recalled again.

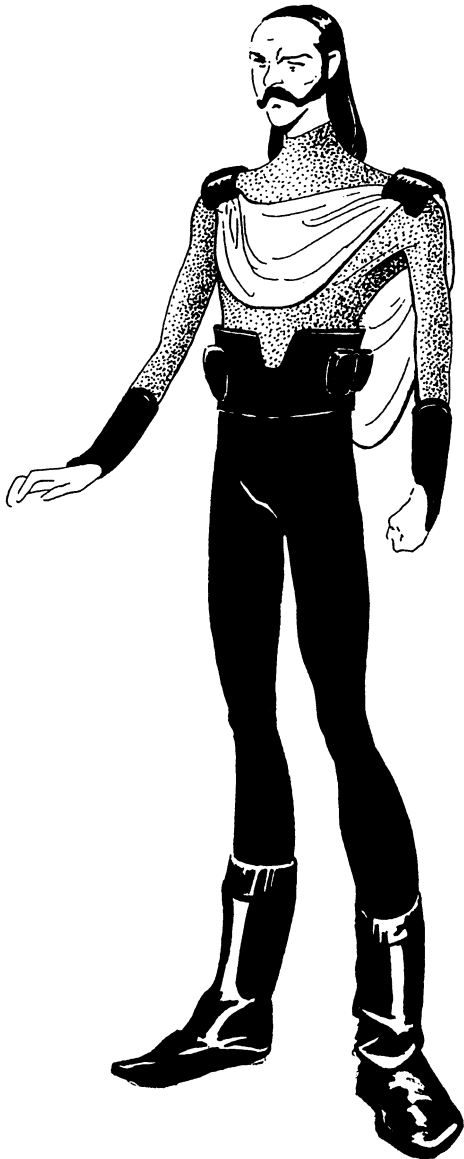

THE CLONE MASTERS

One of the elite ranks in the Robotech Hierarchy is the Clone Masters. The Clone Masters serve two distinct purposes. 1) Military strategists and tacticians, 2) To command and direct the bioroid pilots. Except for the third stage clones, the bioroid pilots are reactionary, fighting brains that respond only to combat stimulation. It is the Clone Masters, in units of three, that control, direct and maneuver the lumbering dreadnoughts as a logical combat force. It is the Clone Masters who manipulate the bioroids to function as a team. Without their telepathic direction the bioroids would fight without focus, lashing out at any enemy they may spy.

The Clone Masters also control the non-combatant, worker bioroids, and provide instructions/commands to the cloned, third stage, bioroid leaders and Invid Fighters. The Clone Masters are not physically trained warriors and are, generally, as helpless in a fight as the Robotech Masters. They are able to vent their frustrations and aggressions through the actions of their clone slaves.

A TYPICAL CLONE MASTER

Hit Points: 50 S.D.C.: 10

Alignment: Always Diabolic, Miscreant, or Anarchist

Attributes: I.Q. 15 + 1D6, M.E. 15 + 1D6, M.A. 16 + 1D6, P.S. 2D6, P.P. 2D6, P.E. 3D6, P.B. 2D6, Spd. 3D6

Age: Unknown; effectively immortal.

Weight: 160lbs **Height:** 6ft (1.8m)

Disposition: Arrogant, clever, cunning; good strategists and tacticians. They are obsessed with the restoration of order and the return of the protoculture factory lost on the SDF-1.

Rank: Elite; second only to the Robotech Masters.

Skills: Intelligence, Interrogation, Hand to Hand Combat techniques (used to direct Bioroids, but can not actually fight for themselves), all Technical skills, Military Strategy and Tactics. All skills are at a 92% level of proficiency.

Combat Abilities: One attack per melee, automatic parry, +1 to dodge.

Psionic Abilities: Extended telepathy and empathy. The nature of the ability is identical to the Robotech Masters', but the range is increased to 1200ft (365m).

MISTRESS OF THE COSMIC HARP (Musika)

The Robotech Masters' gargantuan asteroid-type motherships possess a Mistress of the Cosmic Harp. The "cosmic harp" is a musical instrument composed of light beams instead of strings. Breaking the beam of light will emit a musical tone. Hand gestures through the harp's light beams create music. The music is piped throughout the spacecraft and has a soothing effect on the clones that dwell within. The music can be manipulated to soothe and sedate, or to stimulate and actually motivate and direct clone activity. In this way, the Robotech Masters can maintain a constant, harmonious pattern of clone productivity. Without the cosmic harp, or its mistress, the clones become confused, agitated and hostile.

A TYPICAL MISTRESS OF THE COSMIC HARP

Hit Points: 30 S.D.C.: 10

Alignment: Always Anarchist or Unprincipled

Attributes: I.Q. 6 + 1D6, M.E. 6 + 1D6, M.A. 18 + 1D6, P.S. 6 + 1D6, P.P. 10 + 1D6, P.E. 6 + 1D6, P.B. 12 + 1D6, Spd. 6 + 2D6

Weight: 110lbs **Height:** 5ft 8in (1.7m)

Rank: Mistress of the Harp; a unique member of the sect of Clone Master. They fall last, under the Scientists, in the Robotech Hierarchy.

Skills: None, other than playing the Cosmic Harp.

Combat Abilities: One attack per melee, with no additional abilities or bonuses.

Psionic Abilities: Limited empathy identical to the Robotech Masters.

Note: The Mistress of the Cosmic Harp is one of a special triumvirate of clones which have served the Robotech Masters for countless ages.

THE SCIENCE MASTERS

Another elite segment in the Robotech Hierarchy is the Robotech Scientist. The scientists are the only ones among the Robotech Masters who have a full understanding of the intricate workings of protoculture

and robotechnology. It is they who have developed protoculture techniques in cloning, mechanics and energy. The scientists continue to experiment with Robotechnology, as well as maintaining the bioroids, spacecrafts, and all other technological wonders.

Like their comrades, they are not physically oriented and possess no combat training or physical aptitude. Also, like their fellow techno-voyagers, the scientists view other life forms as scientifically interesting, but clearly inferior to them and the Robotech Masters. Their callous view toward life, compounded by their cunning, makes them extremely dangerous.

They are consumed with retrieving the last known supply of protoculture from the wreckage of the SDF-1. Without it the Robotech Masters are doomed to oblivion. The existing supply of protoculture is extremely old and nearly devoid of energy. While an alternative energy source could be put into use, the ability to manufacture their clones would be lost. Without clone slaves their entire lifestyle would be threatened. Worse yet, mortality would become a reality again. For without new, clone bodies the Masters would be trapped in their old, deteriorating bodies, succumb to age, and die. With death would come the end of the Robotech Master's intergalactic dynasty.

A TYPICAL ROBOTECH SCIENTIST

Hit Points: 40 S.D.C.: 10

Alignment: Always Anarchist or Miscreant

Attributes: I.Q. 18 + 1D6, M.E. 14 + 1D6, M.A. 10 + 1D6, P.S. 2D6, P.P. 10 + 1D6, P.E. 6 + 3D6, P.B. 2D6, Spd. 3D6

Age: Unknown; effectively immortal.

Disposition: Analytical, calculating, methodical, arrogant; dedicated to the development of robotechnology.

Rank: Elite members of the Robotech hierarchy following the Clone Masters.

Skills: All Science, Technical, Electrical, Mechanical and Medical. Skills are at a 94% level of proficiency.

Combat Abilities: One attack per melee, automatic parry, no bonuses.

Psionic Abilities: Telepathy, empathy and total recall. The psionic powers are identical to the Robotech Masters'.

THE TYROLIAN CITIZENS

The people who populate the Robotech Masters' massive spacecraft consider themselves citizens of the planet Tyrol, the homeworld of the Masters. In reality, they are hundreds of *triplet* clones, created from the original people, to populate new planets. They have some knowledge of history, technology, and even Robotechnology, but not enough to act on their own or threaten the Robotech Masters' power structure. They are simply pawns in a much larger game. Under the effects of the Cosmic Harp they are completely loyal to their Masters and operate as a productive microcosm of society.

A TYPICAL TYROLIAN CITIZEN (Clone)

Hit Points: 20 S.D.C.: 10

Alignment: Any, usually Anarchist

Attributes: I.Q. 10 + 1D4, M.E. 6 + 1D6, M.A. 6 + 1D6, P.S. 6 + 1D6, P.P. 6 + 1D6, P.E. 8 + 1D6, P.B. 10 + 1D6, Spd. 6 + 1D6

Age: Unknown

Disposition: Arrogant toward other life forms, fearful and suspicious of strangers, mundane, bland, complacent.

Level of Experience: 2nd level.

Skills: Exact skill knowledge varies, but the most common are those which follow: Radio: Basic, Basic Electronics, Pilot Hover Vehicles, Read Sensory Instruments, Mathematics Basic and Advanced, and Computer Operation.

Psionic Abilities: Limited empathy identical to the Robotech Masters'.



BIOROID BASIC PILOT A First Stage Clone

The most rudimentary clone, bioroid pilot is a non-human entity that resembles little more than clumps of flesh. The secret to mecha mobility is interaction with a living creature. Without a humanoid to connect with it in a symbiotic linkage, the mecha is just another machine. However, when joined with a humanoid it can respond as an extension of that person, with an agility that is impossible to recreate in ordinary machines. The first stage, protoplasmic type, clone is an attempt to satisfy the requirements needed to create a biological link with a bioroid.

The first stage clone can't really be called intelligent, but it does have a brain programmed for combat. It recognizes, and responds to combat like a living computer. However, the incompletely formed, humanoid clone can not respond quite as well as a second stage clone. *Use the standard bioroid hand to hand abilities with the following modifications:* No bonus to strike; +2 to dodge, instead of +3. All other abilities are unchanged.

The first stage clones operate the *worker bioroids*, as well as some of the blue, standard bioroids. As usual, they are directed by the telepathic guidance of the Clone Masters.

It is pointless to give these undeveloped clones any statistical data because they can only function when inside a bioroid, and even then, only in the most minimal capacity. *See the Worker Bioroid and Standard Bioroid.*

BIOROID DRONE PILOT A Second Stage Clone

The bioroid drone is a humanoid clone created and programmed to pilot the blue, standard bioroids. A human(oid) pilot is not required, but preferred because the symbiotic link between the mecha and humanoid is superior to any other. The drone or piloting clone body is devoid of emotion or thought. Its brain is emptied of these distracting characteristics. Instead, it is programmed exclusively for combat as a bioroid. The pilot's only thoughts are primal, basic, actions and reactions. Strike, parry, dodge and strike. Kill or be killed. The semblance of strategy and tactics, teamwork and purpose are instilled by the Clone Masters who control them. Through their telepathic abilities the Clone Masters act as generals, directing their troops in combat with telepathic and empathic messages.

Outside the bioroid, the drone pilot is like a *mindless zombie* awaiting its next call to combat.

If clones can not be manufactured quickly enough to satisfy combat needs, the Robotech Masters can use other, intelligent humanoids to be converted into drone pilots. The process is horrible. The humanoid is subjected to a mind wiping process known as the Zylonic Mental Probe. The probe erases memory and emotion, and programs the empty mind for piloting the bioroids. The process is not unlike a lobotomy. Once the mind is blank, except for its small area of programming, the victim is susceptible to the control of the Clone Masters. **Note:** This happens in the T.V. episode: Metal Fire, #45.

Statistical Data for the drones is pointless because they are really only alive (active, moving, fighting) when inside the bioroids.

Combat Abilities only apply as bioroids. Use only the bioroid hand to hand combat abilities from the Standard Bioroid. (Two attacks per melee, +2 to roll, parry, +3 to dodge, +1 to strike).

BIOROID PILOTS A Third Stage Clone

The bioroid pilot is the most advanced of the three types of piloting entities. They are fully developed, combatant clones. That is to say full humanoid life forms with an active, thinking mind. They are programmed for one thing only: to fight. Somewhat like the Zentraedi, the bioroid pilot is a warrior without fear of death. They are, quite literally, fighting machines.

Like the human's Veritech pilots, the flesh and blood pilot becomes one with his mecha. Linked through a superior symbiosis, the Robotech Master's bioroid responds with even greater speed and agility than the human's. Truly a deadly foe in and out of his mecha.

A TYPICAL BIOROID PILOT (Warrior)

Hit Points: 50 S.D.C.: 30

Alignment: Anarchist

Attributes: I.Q. 8+1D6, M.E. 10+1D6, M.A. 6+1D6, P.S. 12+1D6, P.P.15+1D6, P.E. 8+1D6, P.B. 8+1D6, Spd. 10+1D6

Age: Unknown; grown as needed.

Weight: 180lbs (81.65kg) **Height:** 6ft 4in (1.9m)

Disposition: Very alert, observant, and hostile toward all other life forms. The programming limits the scope of emotions and thoughts. They are hunters and destroyers.

Rank: Top level combat clone.

Level of Experience: Equal to 6th level.

Skills: Hand to Hand: Expert, Pilot Bioroid, Bioroid Combat, Pilot Bioroid Hover Craft — 90%, Prowl — 80%, W.P. Blunt, W.P. Automatic Pistol, W.P. Energy Pistol, W.P. Energy Rifle. **Note:** *These clones pilot the green and red leader bioroids.*

Psionic Abilities: Limited telepathy and limited empathy. Both powers are identical to the Robotech Masters'.

THE INVID FIGHTER PILOTS

The pilots of the Invid Fighter Bioroids are basically identical to the Bioroid Pilot, except that they are cloned as triplets and fight as three. During combat the triplets fight and act as one unit. All three will attack the same target, fire at the same time, and maneuver the same.

All other data is identical to the bioroid pilot.

BIOROIDS

Non-Combatant Worker (Grey)

Standard Bioroid (Blue)

Standard Bioroid (Green)

Leader Bioroid (Red)

Invid Fighter Bioroid (Red; always in threes)

BIOROID WORKER

The workhorse of the Robotech Masters is the Bioroid Worker. It is somewhat broader built and shorter than its combat brethren, but equally tough. The Worker is used for construction, repairs in space, recovery, and any manual labor that requires great strength. These brutes can lift and carry weights of up to *60 tons*. These bioroids are piloted by first stage clones; consequently, they are more machine than living creature.

As a combat weapon the worker is a washout. It is designed for strength; therefore, lacking the speed and agility of the other bioroids. It can barely muster a running speed of 15mph (24kmph) and is lucky if it can leap a 10ft (3m) hurdle without falling on its face. On the other hand, the fool who gets into punching range is going to get hit with the wallop of a pile driver.

The worker has no conscious thoughts of its own. Its feeble brain is programmed for labor, is directed by the Clone Masters and kept placated by the harmonious melody of the Cosmic Harp.

BIOROID WORKER

Crew: One

M.D.C. by Location:

Head — 75

Hands — 40 each

Arms — 75 each

Legs — 100 each

*Main Body — 200

*Depleting the M.D.C. of the main body will shut the bioroid completely down.

Speed: 15mph (24kmph) running. It can not leap or perform feats of agility, such as rolls, somersaults, dodges, and similar.

Height: 18ft (5.5m)

Width: 10ft (3m)

Weight: 18 tons

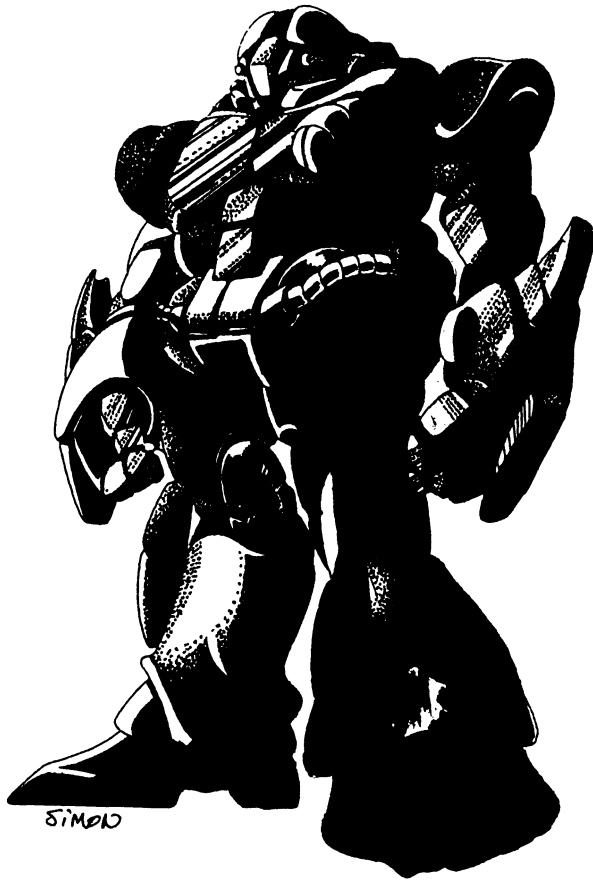

STANDARD COMBAT BIOROID (Blue)

Crew: One

M.D.C. by Location:

Head — 40

Hands — 20 each

Arms — 40 each

Legs — 60 each

Reinforced Pilot's Compartment — 50

*Main Body — 100

Hand Weapon — 50

*Depleting the M.D.C. of the main body will shut the bioroid completely down.

Speed: 30mph (48kmph) running is the fastest it can go. *Special Maneuvers:* Leap straight up into the air 80ft (24.4m), and 40ft (12.2m) lengthwise. This means it can perform leap kicks and other agile stunts.

Height: 22ft (7m)

Width: 10ft (3m)

Weight: 11 tons

Weapon Systems

1. Weapon Drum: Fires explosive, armor piercing projectiles.

Primary Purpose: Assault

Range: 4000ft (1200m)

Mega-Damage: 5D6 M.D. per projectile.

Rate of Fire: 3 *aimed* shots per melee (+3 to strike) or two bursts (+1 to strike). See modern weapon proficiencies; same as automatic weapon.

Payload: Effectively unlimited. (2000 rounds).

Weapon Systems: None

Hand to Hand Combat: One attack per melee. No bonuses to roll, strike, parry or dodge.

Mega-Damage: Restrained Punch — 1D6 M.D.
 Full Force Punch — 3D6 M.D.
 Power Punch — 4D4 M.D.
 Body Block — 1D6 M.D.
 No Kick Attack
 No Stomp Attack (too slow)

STANDARD COMBAT BIOROID

The Standard Combat Bioroid is blue, with a long, trunk-like hose protruding from the lower head to its belly. This is the main combat force in the Bioroid army. Agile, tough, and as quick moving as any Earth mecha, they pose a greater threat than the comparatively flimsy Zentraedi mecha. Their movements and attack formations are orchestrated by the Clone Masters, who move them about like the playing pieces in a game of chess.

The main armament of the blue combat bioroid is a drum-like weapon that fires powerful, armor piercing, explosive ammunition. The explosive projectiles are more effective against troops of the Southern Cross and their laser resistant armor. An even more lethal device is the hover craft or hover sled. The open-air platform allows for maximum movement of its driver, hand to hand combat, and high maneuverability. Mounted in the lower front are two, heavy-duty pulse ion blaster. During combat, the bioroid can leap from the platform to engage in ground combat. The platforms fly out of harm's way under the control of the Clone Masters who oversee.

Stage one and stage two clones are the living occupants of the *blue*, standard bioroid.

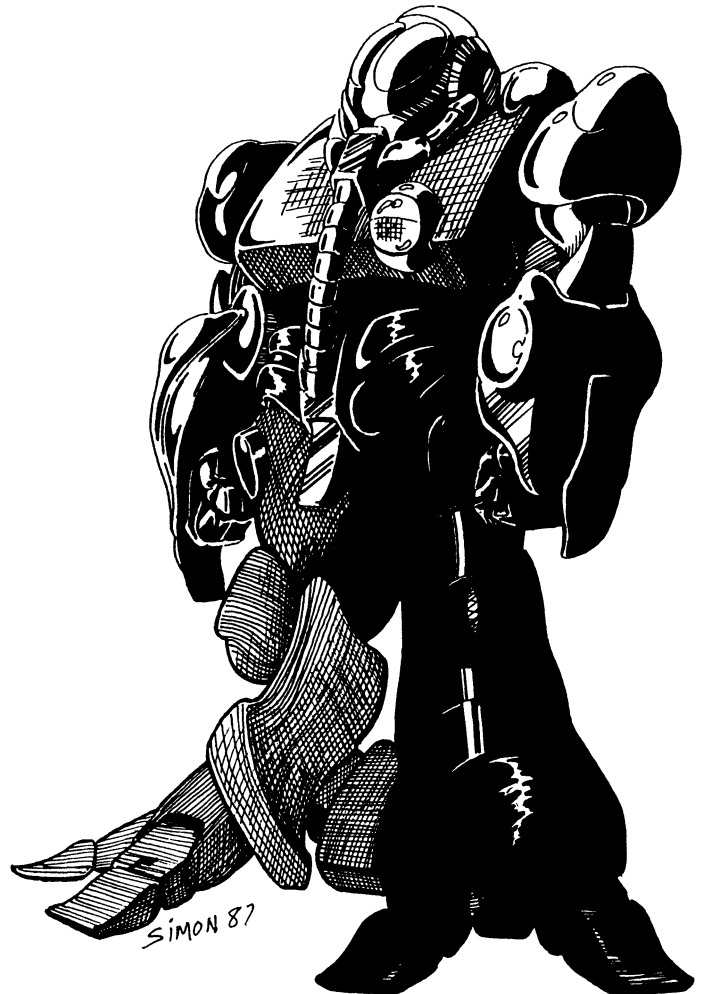

2. Hand to Hand Combat (1st and 2nd stage clones).

- Two hand to hand attacks per melee.
- +2 to roll with punch, fall or impact (explosion), reducing damage by half.
- +2 to parry (can not parry energy blasts or projectiles).
- +2 to dodge.
- Body flip/throw does 1D4 M.D. plus victim loses initiative and one attack that melee.
- Body block/tackle (roll to strike as normal).

Mega-Damage: Restrained Punch — 1D4 M.D.
Full Strength Punch — 1D6 M.D.
Body Flip — 1D4 M.D.
Kick — 1D6 M.D.
Leap Kick — 2D6 M.D.
*Stomp — 1D4 M.D.
*Effective only against small objects (10ft or smaller).

Note: Because the 1st and 2nd stage clones (or Zylonic drone pilots) are so limited, yet consistent, they do *not* grow more skilled with experience *nor* add a pilot's hand to hand combat skills/bonuses to the mecha combat.

3. Optional Use of a Laser Drum Weapon: This looks identical to the first weapon, but fires laser pulses.

Primary Purpose: Assault

Range: 4000ft (1200m)

Mega-Damage: 6D6 M.D. per blast (half damage against laser resistant material).

Rate of Fire: 3 aimed shots per melee or 2 bursts. Same as #1.

Payload: Unlimited

4. Optional Use of Bioroid Hover Craft. See Hover Craft for details.

STANDARD COMBAT BIOROID (Green) Pilot is Second or Third Stage Clone

The next step in the standard combat bioroid is the green mecha. It is fundamentally the same in general appearance, although the head looks more like the *leader bioroid* rather than blue, and the hose-like protrusion connects into the chest rather than the head.

The real differences are unseen. The green bioroid is a little faster, a little tougher, and is often piloted by young, third stage clones. The third stage clones are fully formed humanoids who can act and think for themselves, although always under the influence of the Clone Masters and the Cosmic Harp. The bioroid is at its most agile when piloted by a third stage clone. The young, third stage clone piloting a green bioroid has less combat experience and is equal to a hand to hand expert skill of third level experience. *However, most are piloted by second stage clones.* **Note:** It was one of these green, standard combat bioroids that Dana captures in episode number 45, Metal Fire.

Generally, one out of every 24 blue, standard combat bioroids is a more advanced, green bioroid. Of those, 60% are piloted by second stage clones.

STANDARD COMBAT BIOROID (Green)

Crew: One

M.D.C. by Location:

Head — 50

Hands — 30 each

Arms — 50 each

Legs — 80 each

Reinforced Pilot's Compartment — 50

*Main Body — 150

*Depleting the M.D.C. of the main body will shut the bioroid completely down.

Speed: 35mph (56kmph) running. *Special Maneuvers:* Leap 100ft (30m) high and 60ft (18.3m) across.

Height: 22ft (7m)

Width: 10ft (3m)

Weight: 12 tons

Weapon Systems

1. Weapon Drum: Fires explosive, armor piercing projectiles.

Primary Purpose: Assault

Range: 4000ft (1200m)

Mega-Damage: 5D6 M.D. per projectile.

Rate of Fire: *Stage Two Clones:* 3 aimed shots or 2 bursts. *Stage Three Clones:* Equal to combined hand to hand and mecha combat skills. Usually four attacks per melee.

Payload: Effectively unlimited (1000 rounds).

2. Green Bioroid Hand to Hand Combat: *If a young, third stage clone, the two attacks per melee from hand to hand: expert combat training is combined with the two of the hand to hand mecha combat, for a total of FOUR. Likewise, the bonuses of +2 to strike and +3 to parry, roll and dodge, are also added to the bioroid hand to hand combat skills. As usual, the mecha combat skills only apply to the pilot when inside the mecha.*

If a second stage clone, use the following unmodified combat data.

- Two hand to hand attacks per melee.
- +2 to roll with punch, fall or impact (explosion).
- +2 to parry (can not parry energy blasts or projectiles).
- +2 to dodge.
- +1 to strike.
- Body flip/throw does 1D4 M.D. plus victim loses initiative and one attack that melee.

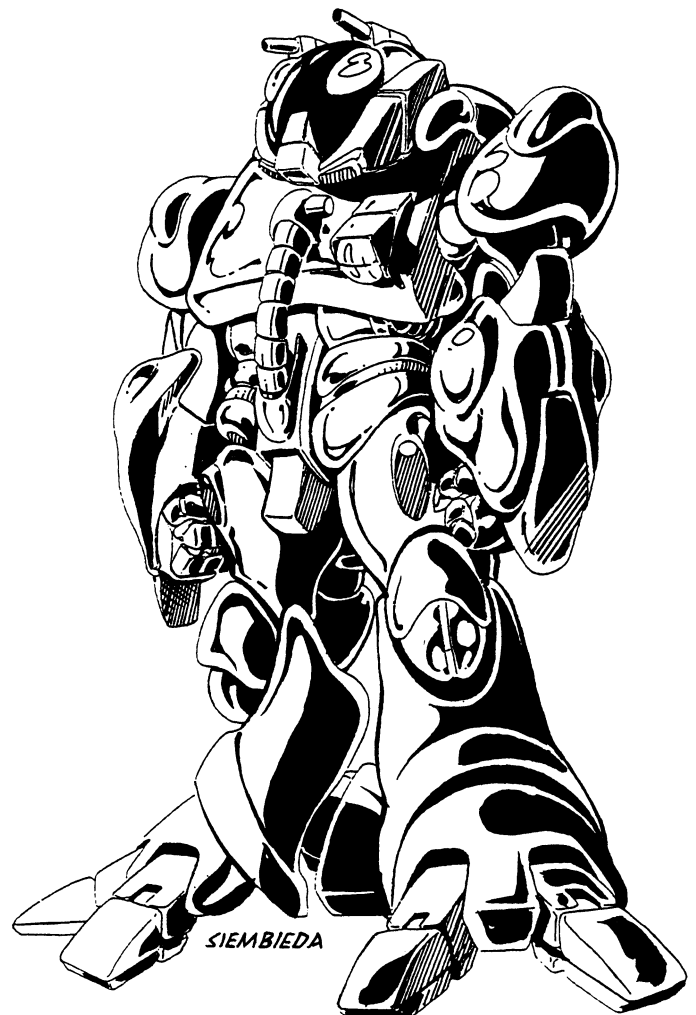

- Body block/tackle (roll to strike as normal).

Mega-Damage: Restrained Punch — 1D4 M.D.
 Full Strength Punch — 1D6 M.D.
 Body Flip — 1D4 M.D.
 Kick — 1D6 M.D.
 Leap Kick — 2D6 M.D.
 *Stomp — 1D4 M.D.
 *Effective only against small objects (10ft or smaller).

3. Optional Use of a Laser Drum Weapon: This looks identical to the first weapon, but fires laser pulses.

Primary Purpose: Assault

Range: 4000ft (1200m)

Mega-Damage: 6D6 M.D. per blast (half damage against laser resistant material).

Rate of Fire: 3 aimed shots per melee or 2 bursts. Same as #1.

Payload: Unlimited

4. Optional Use of Bioroid Hover Craft. See Hover Craft for details.

LEADER COMBAT BIOROID (Red)

Of all the standard bioroid units, the red leader is the most formidable. This bioroid is stronger, faster, and more heavily armored, than the blue or green. In addition to the mecha's enhanced abilities, one must consider its third stage clone pilot. The third stage clone is a fully developed and trained warrior (6th level experience). His own heightened combat skills combined through the symbiotic link shared between man and mecha. The bioroid is faster and more agile, because its humanoid pilot is quicker and more dexterous. It responds as he responds.

In the television series we see Zor, resurrected as a third stage clone, placed in the role of leader bioroid pilot (and later, friend of the Southern Cross). He is an excellent fighter (6th level Expert) outside his mecha and even more deadly, a leader bioroid. See *Bioroid Pilots* for details.

Note: Generally, one out of every 12 blue or green bioroids is a red leader.

LEADER COMBAT BIOROID (Red)

Crew: One

M.D.C. by Location:

Head — 75

Hands — 40 each

Arms — 75 each

Legs — 100 each

Reinforced Pilot's Compartment — 50

*Main Body — 200

*Depleting the M.D.C. of the main body completely shuts the bioroid down.

Speed: 60mph (96kmph) running; can also leap 120ft (36.6m) high and 60ft (18.3m) lengthwise. Leap kicks, rolls, tumbles, and other feats of agility are easy.

Height: 22ft (7m)

Width: 10ft (3m)

Weight: 12 tons

Weapon Systems

1. Bioroid Blaster: Fires explosive, armor piercing projectiles.

Primary Purpose: Assault

Range: 4000ft (1200m)

Mega-Damage: 1D4 × 10 per shot.

Rate of Fire: Equal to the combined hand to hand attacks of the pilot.

Payload: Effectively unlimited (1000 rounds).

2. Red Leader Bioroid Hand to Hand Combat:

- Two hand to hand attacks per melee (Plus those of the pilot for a total of five).

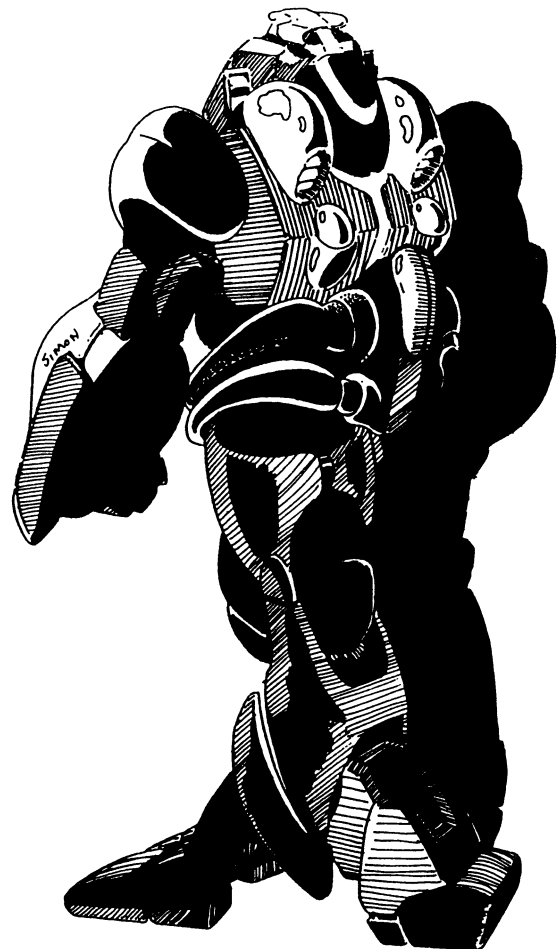
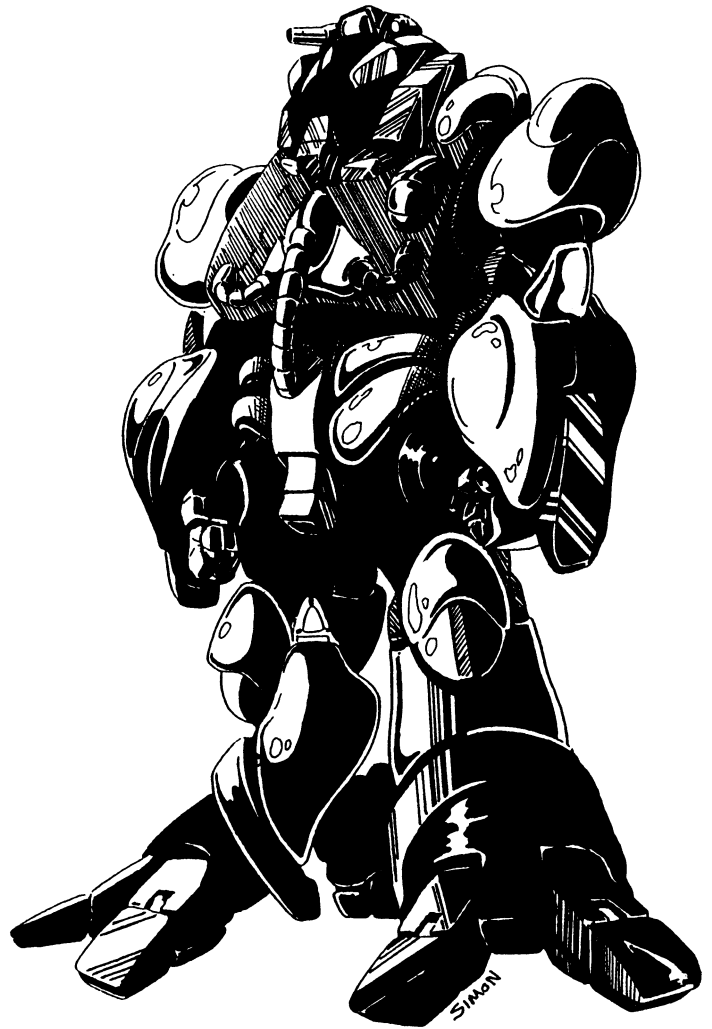

- +3 to roll with punch, fall or impact (explosion), reducing damage by half.
- +2 to parry (can not parry energy blasts or projectiles).
- +3 to dodge.
- +2 to strike
- Body flip/throw does 1D4 M.D. plus victim loses initiative and one attack that melee.
- Body block/tackle (roll to strike as normal).
- Critical strikes the same as pilot's hand to hand.
- One additional attack at level eight.
- On additional attack at level twelve.

Mega-Damage: Restrained Punch — 1D6 M.D.
 Full Strength Punch — 2D6 M.D.
 Power Punch — 2D6 + 4 M.D.
 Tear or Pry — 1D6 M.D.
 Kick — 1D6 M.D.
 Leap Kick — 2D6 M.D.
 *Stomp — 1D6 M.D.
 *Effective only against small objects (10ft or smaller).

Note: Remember, these bonuses are in addition to the pilot's own hand to hand training and attribute bonuses. They do not apply to the pilot's physical abilities outside of the mecha.

3. Optional Use of a Laser Blaster: This looks identical to the Bioroid Blaster, but fires a high intensity laser pulse. Remember, the Southern Cross mecha and body armor uses laser resistant material which takes half damage from laser weapons

Primary Purpose: Assault

Range: 4000ft (1200m)

Mega-Damage: 1D6 × 10 M.D.

Rate of Fire: Equal to the combined hand to hand attacks of the pilot.

Payload: Unlimited

4. Optional Use of Bioroid Hover Craft. See Hover Craft for details.

THE BIOROID INVID FIGHTER

The most sophisticated version of the Robotech Master's bioroid system is the Invid Fighter. At first glance these fighters resemble the Leader Bioroid, for it too is red and incredibly agile. A closer look will reveal a different looking head and two hose-like appendages attached at the abdomen and shoulders. Observation of the Invid Fighters in combat will reveal their most deadly secret: *Three fight as one.*

The Invid Fighters are created and dispatched in units of three. Each of the three are piloted by identical, third stage clones. Through the mysterious link of the triumvirate (3), and direction from the Clone Masters, the three fight as one. They will move at the same time, simultaneously attack the same target, shoot at the exact same moment, and fight without pause until all three are destroyed.

Fortunately, the bioroid triplets have a major weak spot. Destruction of the head will completely immobilize the bioroid. **Note:** You can see the Invid Fighters in action in the episode: *Mind Game, number 54.*

Game Master's Note: The Invid Fighters are only used in extreme cases, and are considered the secret weapon in the Robotech Masters' arsenal. When they come into play they will always be in sets of three; never less, never more. While the three may disperse to avoid attack, they will never leave the sight of the other two. Attacks per melee *can* be divided against several foes, but all three will fire/attack at the same foe. For Example: Three Invid Fighters are locked in combat with four Veritech Hover Tanks (VHT). All three bioroids have fanned out about 200ft (61m) apart; suddenly, all three fire at the VHT behind a boulder, then all three turn and fire at a VHT shooting from the other direction. The center bioroid dodges out of the way of a blast from its backside. As it dodges, it spins to look at its assailant; the other two also turn to look at the same area (an action that takes the place of an attack). All

three fire at the new target, ignoring blasts from other directions. One of the Invid Fighters is blown to bits. Now the other two will fight until destroyed. They turn (another action) and fire at the destroyer of their brother.

We see six combat actions or attacks in one melee (dodges and turning around completely always use up one attack). All three and then two, bioroids fight in unison. Separate, but equal; three who act as one. If one is killed, the other two will fight to the death.

BIOROID INVID FIGHTER (Triumvirate)

Crew: One; 3rd level clone in each; 3 bioroids per unit.

M.D.C. by Location:

*Head — 75

Hands — 40 each

Arms — 75 each

Legs — 120 each

Reinforced Pilot's Compartment — 50

**Main Body — 250

*Depleting the M.D.C. of the head will completely immobilize the Invid Fighter. However, to hit the head, the player must make a "called shot".

**As usual, depleting the M.D.C. of the main body completely shuts down the bioroid and probably kills the pilot.

Speed: 60mph (96kmph) running. It can also leap 120ft (36.6m) high and 60ft (18.3m) lengthwise. All other feats of agility are possible.

Height: 22ft (7m)

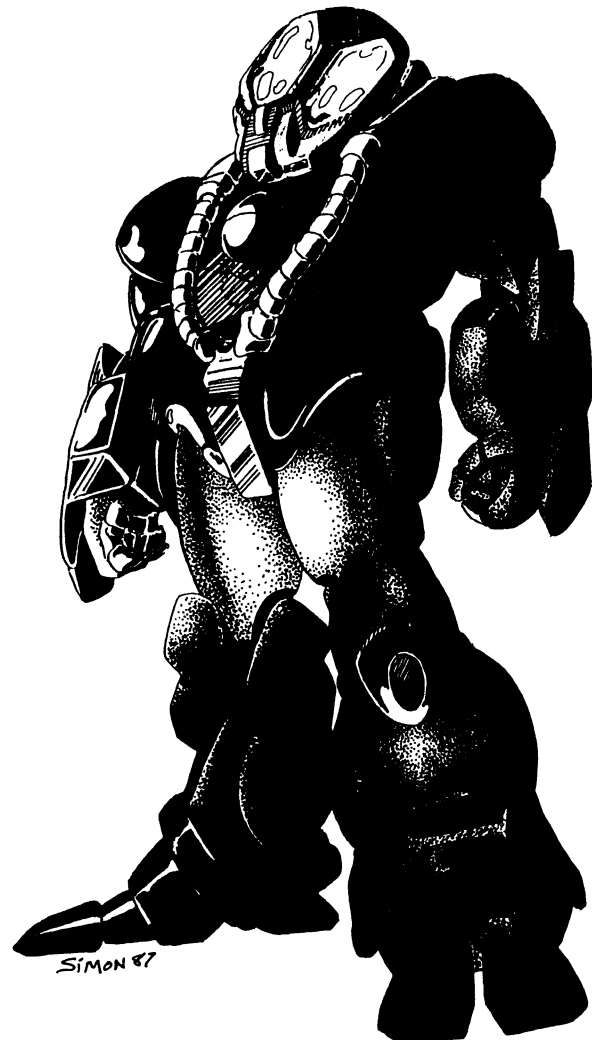

Width: 10ft (3m)
Weight: 12.5 tons

Weapon Systems: *Identical to the Leader Bioroid (Red).* Hand to Hand Combat is as follows:

Invid Fighter Hand to Hand Combat:

- Four hand to hand attacks per melee (Plus those of the pilot for a total of six).
- +4 to roll with punch, fall or impact (explosion), reducing damage by half.
- +2 to parry (can not parry energy blasts or projectiles).
- +4 to dodge.
- +2 to strike.
- Critical strikes are the same as the pilot's hand to hand skill. Remember, bioroid pilots are third stage clones trained in Expert Hand to Hand equal to sixth level proficiency.

Mega-Damage: Full Strength Punch — 2D6 M.D.
 Power Punch — 3D6 M.D.
 Tear or Pry — 1D6 M.D.
 Kick — 1D6 M.D.
 Leap Kick — 2D6 M.D.
 *Stomp — 1D4 M.D.
 *Effective only against small objects (10ft or smaller).

Also see Bioroid Pilot descriptions.

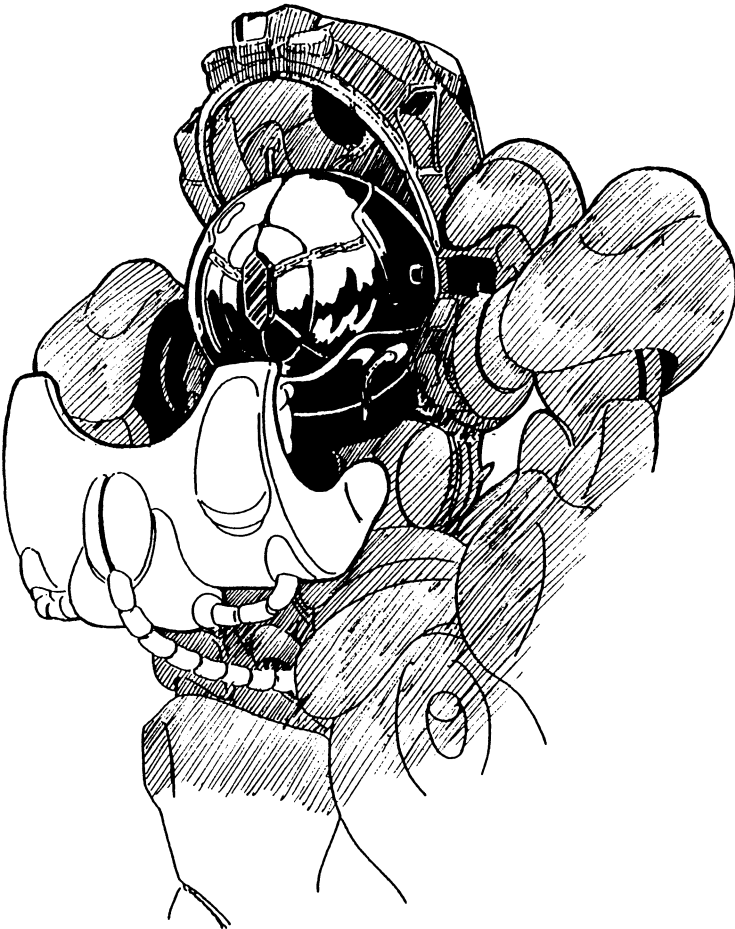

An opened Leader Bioroid mecha, revealing the reinforced pilot's compartment. Within the sphere sits the bioroid pilot. In the case of the Leader Bioroid mecha (red) the pilot is a third stage clone. The most advanced of its two brothers.

BIOROID BLASTER

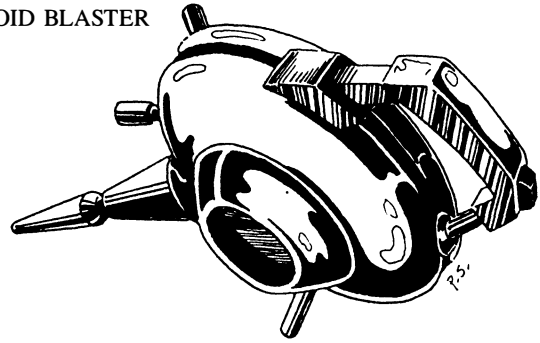

WEAPON DRUM

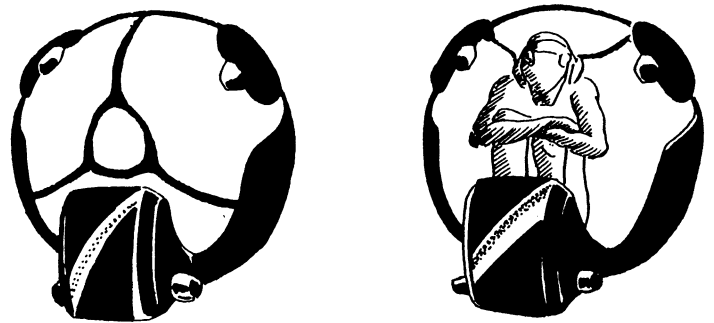
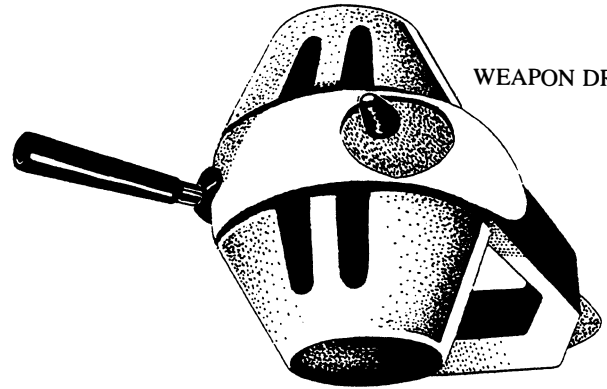

The visor-type apparatus is the link between mecha and clone. It is through this mechanism that the pilot controls his bioroid. The visor also serves as a heads-up display for data and targeting.

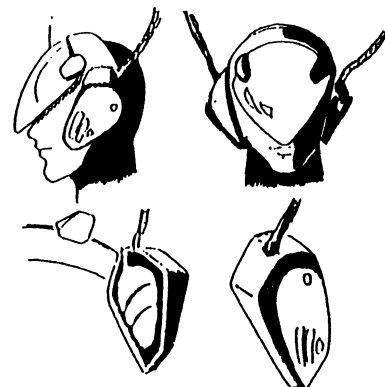

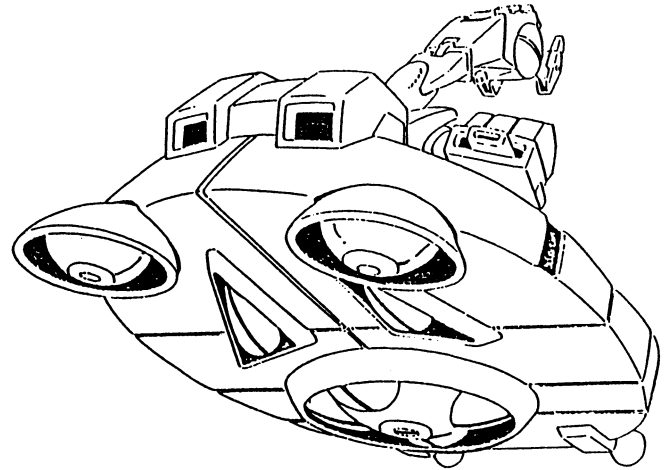
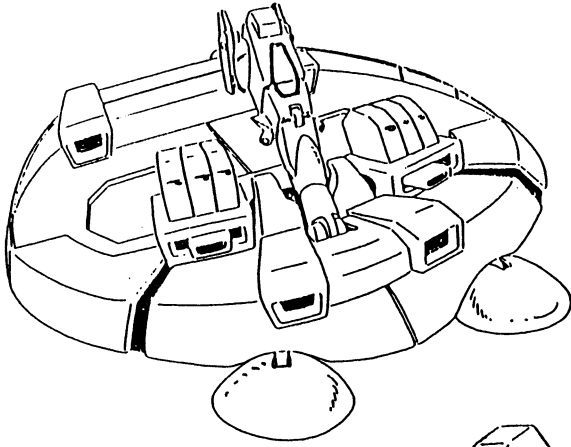

DUAL ION BLASTERS

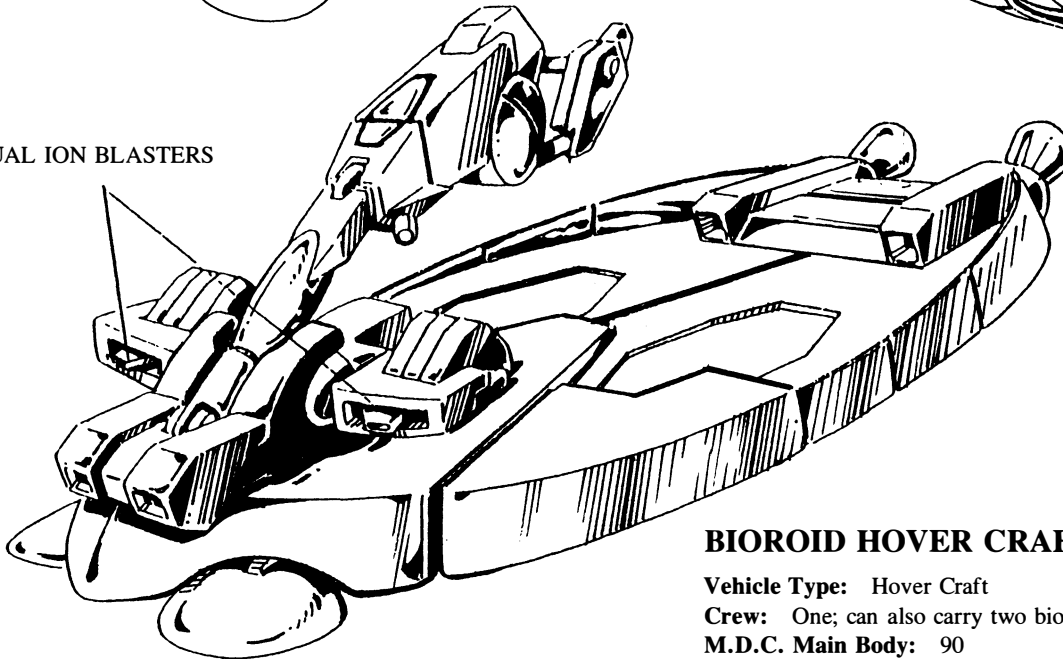

BIOROID HOVER CRAFT

The bioroid hover craft is a combination transportation and assault platform. Maneuverability of the platform is unparalleled. It can hover stationary, attain speeds of nearly 200mph, maneuver through narrow streets and corridors, fly as low as 3ft (0.9m) above the surface or as high as 2000 feet (609m), stop on a dime, accelerate to maximum speed within a few seconds, and can fly straight up and down, as well as forward.

Two high-powered ion blasters are recessed in the front of the hover craft. These can be fired instead of the hand held weapon or simultaneously. A simple hand control in the handle of the platform allows easy, one-handed, firing.

The hover craft also has what might be called a remote control capability. Often the bioroids will leap off their vessel in mid-flight to engage ground troops, while the hover craft flies off, apparently under its own power. Then, as if by some mental or imperceptible command, the vehicles zoom back into battle, the bioroids leap back on them and continue to fight or depart. The hover crafts can be controlled by the pilot and/or the *Clone Masters*. It is the Clone Masters and their assistants in the *assault craft* who direct the pilotless vehicles. When a new battle formation or maneuver is required, the Clone Masters telepathically communicate with their bioroid legions and send the hover craft back to them. All bioroids use the hover craft.

BIOROID HOVER CRAFT

Vehicle Type: Hover Craft

Crew: One; can also carry two bioroid size passengers.

M.D.C. Main Body: 90

Speed: 190mph (305kmph) in an atmosphere, 360mph (579kmph) in space. Hover stationary — 3 feet (0.9m), maximum altitude — 2000ft (609m), or as low as 3ft (0.9m) above the ground. Exceptional mobility.

Engine: Anti-Gravity

Range: Unlimited miles.

Length: 31ft (9.4m)

Weight: 8 tons

Bonuses: +5 to dodge

+2 to strike with blasters (no other bonuses apply).

Weapon Systems

1. Dual Ion Blasters are mounted in the front of the hover platform.

Primary Purpose: Assault/Defense

Range: 6000ft (1800m)

Mega-Damage: 2D4 × 10 per individual shots or 4D4 × 10 per burst.

Rate of Fire: Equal to the combined number of hand to hand attacks of the pilot. Or *two bursts* per melee.

Payload: Unlimited.

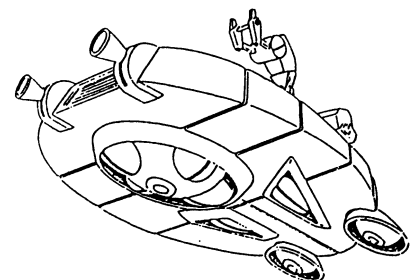

ROBOTECH ASSAULT CARRIER

The Robotech Assault Vessel is a combination attack ship and bioroid troop carrier. It has a half a dozen, forward mounted cannons, and a rapid-fire rotary blaster on its underbelly. The pilots, a triumvirate (3), operate the vessel from the elongated dome on top of the craft. This is also where the sensory system and the telepathy amplification system (used by the Clone Masters to direct and observe the bioroids) is located.

The assault carrier is extremely mobile. An ability to hover provides all terrain landing capabilities. However, the ship does not have to land on solid ground to release its troops. The Combat Bioroids can exit from both or either of the large, side doors, while in mid-air or on the ground.

- Bonuses:** +4 to dodge, +6 at Mach 5.
 +3 to strike with main cannon.
 +2 to strike with rotary turret.
 +1 to strike with secondary guns.

Weapon Systems

1. **Forward, Dual Ion Cannons** are mounted in the front of the assault craft. These main guns have a 90 degree arc of fire up and down.

- Primary Purpose: Assault/Defense
Mega-Damage: 2D6 × 10 per double blast.
Range: 6000ft (1800m)
Rate of Fire: Two per melee.
Payload: Unlimited

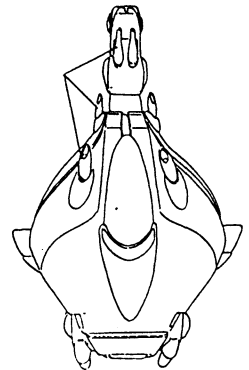
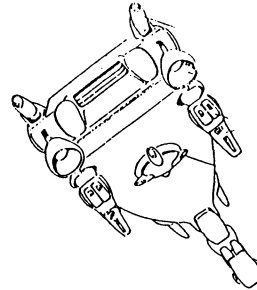
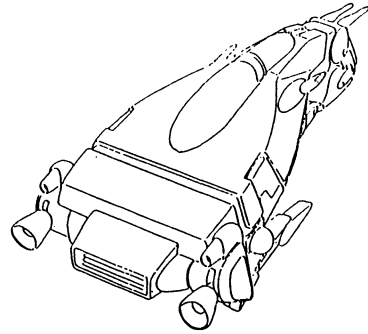
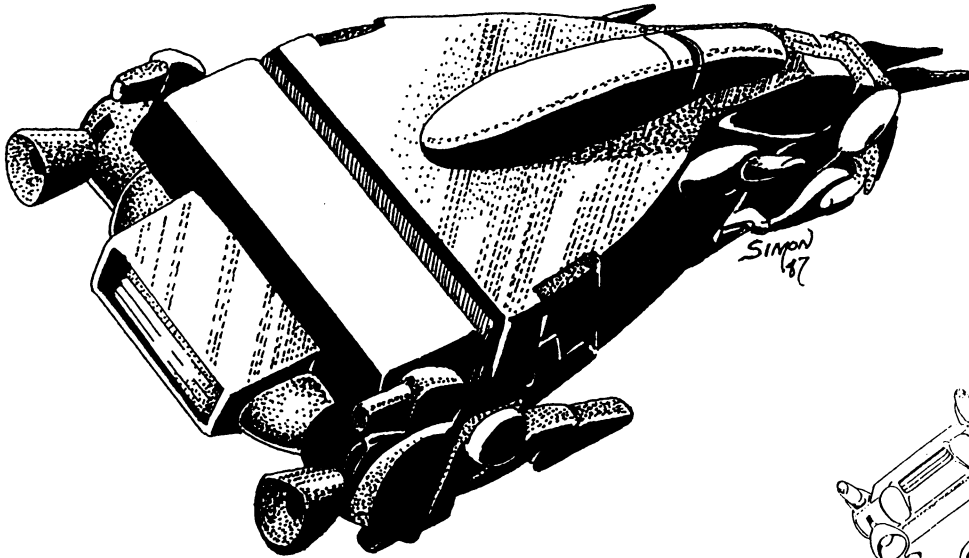

ROBOTECH ASSAULT CARRIER

Vehicle Type: Assault Carrier

Crew: Three

Passenger Cargo: Up to 72 bioroids with hover craft.

M.D.C. by Location:

- Landing Claw — 80
- Main Cannons — 100
- Landing Feet (2) — 100
- Secondary Cannons (4) — 70 each
- Rotary Turret — 80
- *Pilot Dome/Sensory System — 120
- Reinforced Pilot's Compartment — 300
- **Main Body — 1000
- Rear Thrusters (2) — 300 each
- Hatches (2) — 150 each

*Inflicting 120 M.D. or more to the Pilot/Sensory Dome will knock out the sensory and communications system, forcing the ship and its troops to withdraw for repairs. However, to hit the dome top the person must have the proper angle to see and hit the target, and it must be a "called shot". *Additional Damage* on the dome is subtracted from the reinforced pilot's compartment.

**Depleting the M. D. C. of the main body destroys the vessel.

Speed: Hover stationary, or transatmospheric speeds of up to 3350mph or Mach 5. Typical cruising speed is Mach 2. Capable of complete stops in mid-air, and vertical landing and take-off.

Range: Unlimited

Length: 400ft (121.9m)

Width: 140ft (36.5m)

Weight: 180 tons; 670 tons — fully loaded.

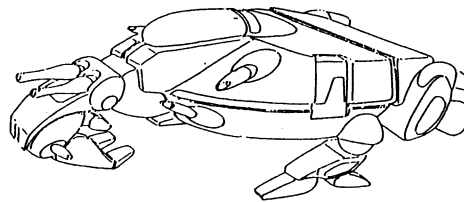

2. **Secondary Laser Cannons (4)** are mounted in the forward section of the vessel. These can rotate in a 45 degree angle.

- Primary Purpose: Defense/Assault
Range: 4000ft (1200m)
Mega-Damage: 1D4 × 10 per each blast
Rate of Fire: Once each (4) per melee.
Payload: Unlimited

3. **Rotary Blaster Turret**, with 360 degree rotation, is located on the underside of the assault craft.

- Primary Purpose: Defense/Assault
Range: 4000ft (1200m)
Mega-Damage: 4D6 per aimed blast or 1D6 × 10 per rapid-fire burst.
Rate of Fire: Six aimed blasts per melee or three bursts per melee.
 Note: In this case the bursts have no bonuses to strike.

4. **Deployment of Bioroids:** A typical Robotech Assault Carrier will transport 24 to 36 bioroids, but can carry as many as 72 bioroids, complete with hover craft, if necessary.

COMBAT NOTE

Attacks Per Melee: *As many as 12.* Each of the three pilots operate one of the three weapon systems. Consequently, all weapons can be fired within the same melee.

THE BIOROID TERMINATOR

The Terminator is a second stage clone in battle armor. The Terminator has two distinct purposes. 1) To locate and “terminate” renegade or malfunctioning clones (at the direction of the Clone Masters), and 2) Guard private quarters and restricted areas within the Robotech Masters’ mothership.

A sensor web, built into what appears to be an armored overcoat, enables the Terminator to hunt and destroy its target. The main weapon is a heavy laser rifle, but any handheld weapon available can be used.

Despite the Terminator’s fearsome appearance, it is an inadequate opponent against human mecha and only a fair threat to the human’s elite fighting forces. Still, it can be a dangerous foe and should not be underestimated.

THE TERMINATOR

M.D.C. of Body Armor: 50

Hit Points: 40 **S.D.C.:** 20

Speed: Equal to the physical attribute of speed 14.

Height: 6ft (1.8m)

Weight: 200lbs (90kg)

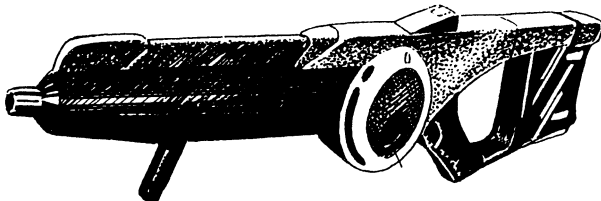

Weapon Systems

1. **Heavy Laser Assault Rifle:** A hand held weapon.

Mega-Damage: 4D6 M.D.

Range: 800ft (244m)

Rate of Fire: 5 blasts per melee.

Payload: 50 shots per E-Clip.

2. **Hand to Hand Combat:** Equal to a 5th level, Basic Hand to Hand skill. 3 attacks per melee, +1 to strike, +2 to roll with punch, fall or impact, and +2 to dodge. **Damage:** 2D4 S.D.C. (not M.D.C.) from a punch or kick.

SPECIAL EQUIPMENT

Motion Detector: Detects and registers movement in the air. Range: 200ft (61m). Can pinpoint up to 20 targets.

Radar: Range: 6 miles (12.8km)

Telescopic Optics: Range: 1600ft (488m)

Thermo-Imager Optics: Converts the infrared radiation of warm objects into a visible image. Can see in darkness and through smoke.

Infrared and Ultraviolet Optics: Sees into the infrared and ultraviolet range of light radiation. Range: 1600ft (488m).

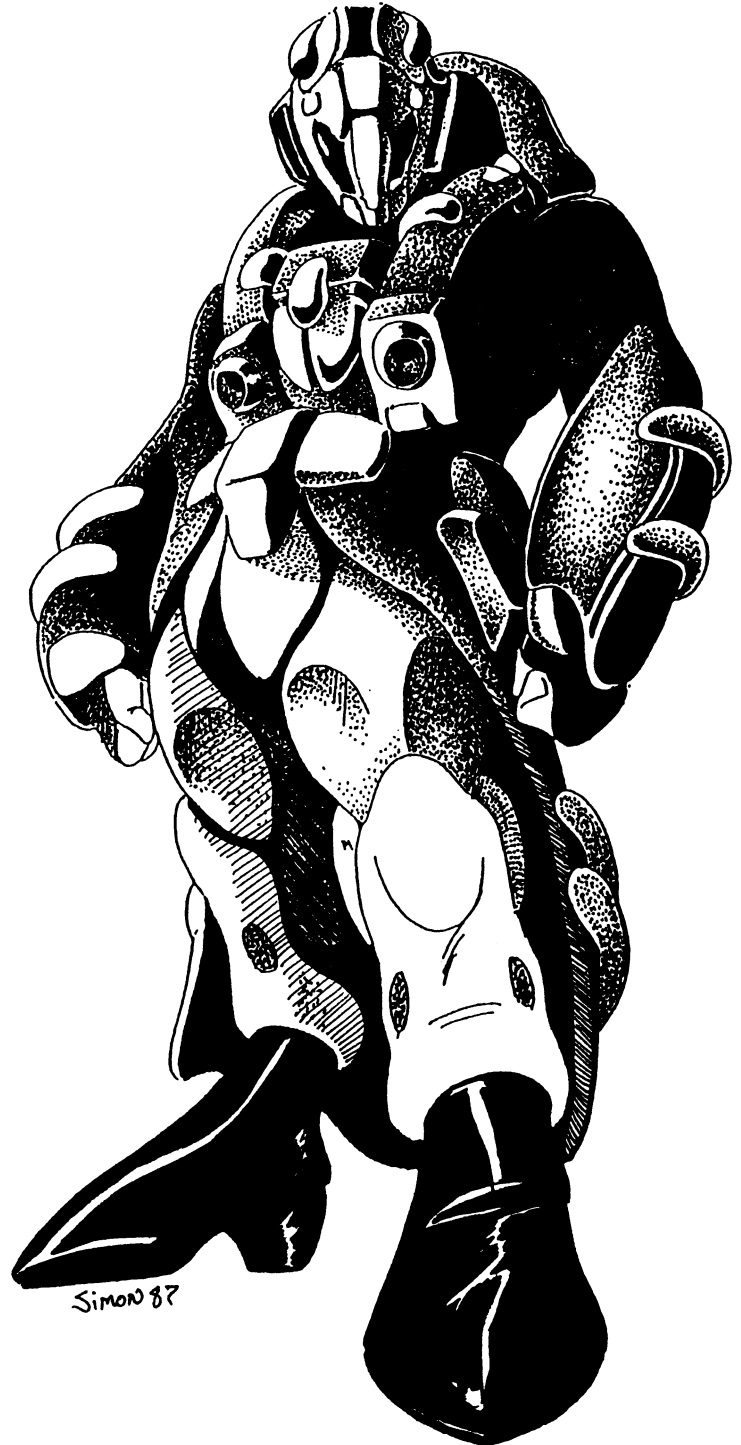

THE ROBOTECH MASTERS' MOTHERSHIP

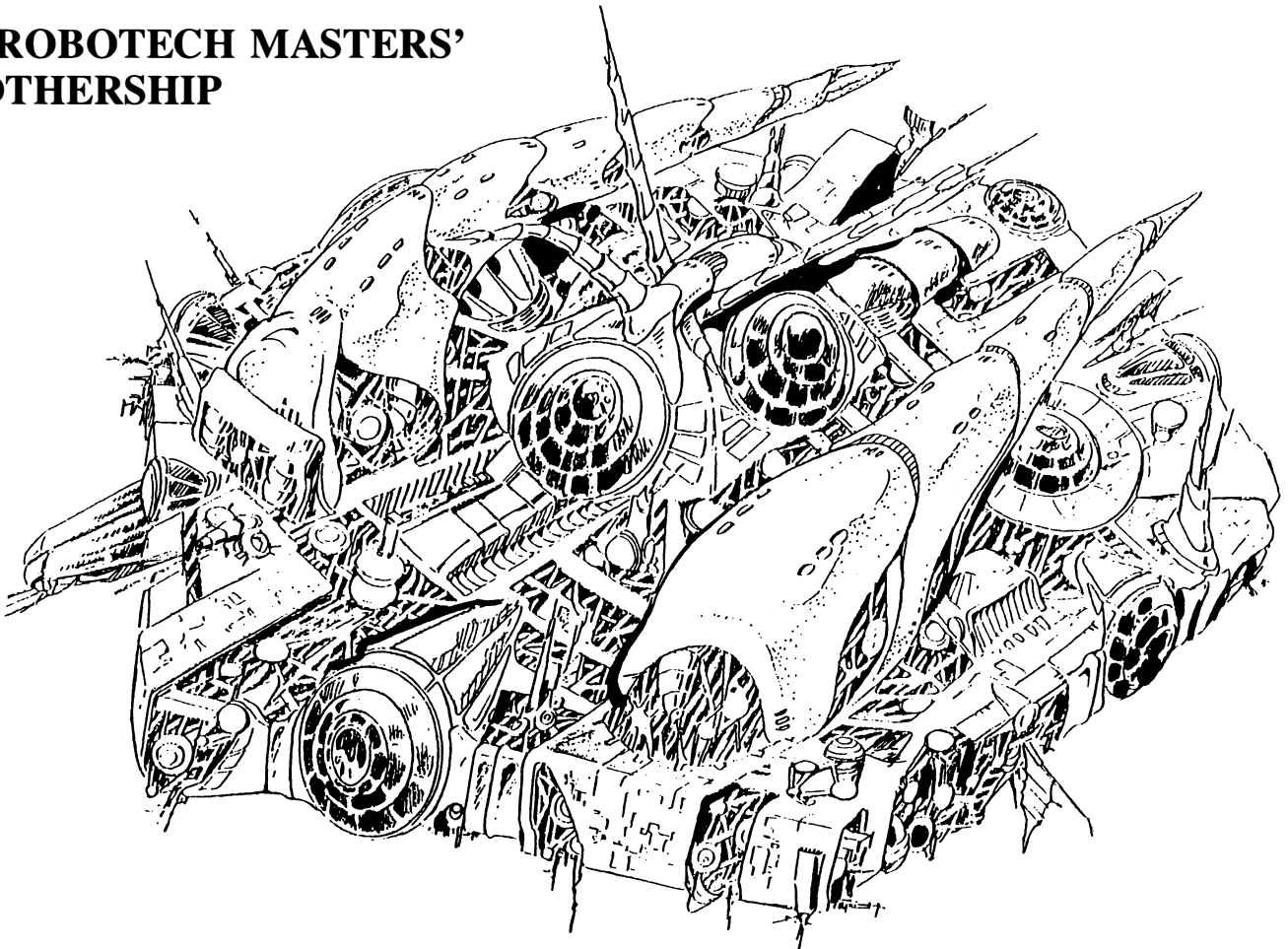

Little is actually known about the gargantuan spacecraft of the Robotech Masters. The vessel is designed for all space conditions and has been the wandering home of the Robotech Masters for centuries. Consequently, the mothership is a completely self-contained environment, with oxygen purification and purge system, circulatory system, water storage, food manufacturing, bio-protoculture cloning facilities, laboratories, medical facilities, bioroid manufacturing/storage areas, abandoned areas, weapons manufacturing, protoculture chamber, generator rooms, and a level that resembles medieval Italy with its stone pillars and intricate relief carvings. The latter is where the so-called Tyrolian citizens live.

The exterior of the mothership has a vague, flat, wedge shape, with large and small outcroppings, spheres, horns, towers, and appendages of all kinds. The outside looks ancient and deteriorating. Tucked away in their little niches are hundreds of weapon turrets, as well as hatches for assault craft and bioroids.

M.D.C. by Location:

Main Towers (2) — 30,000 each
Particle Beam Cannons (30) — 1000 each
High-Powered Laser Cannons (60) — 500 each
Light Lasers (400) — 200 each
Missile Turrets (100) — 200 each
Airlock Access Hatches (300) — 200 each
Forward 1/3 of the ship (main body) — 600,000

Speed: Main engines are capable of sub-light travel, reaching speeds of .20 light years or 32,000 miles per second. Auxiliary Engines can only travel a meager Mach 5.

Dimensions: Length — 9.5 miles (15km)
Height — 1.3 miles (1.9km)
Width — 4 miles (6.4km)

Weight: Beyond estimation.

Gravity Control System: Internal

Fold System: Hyperspace Navigation System

WEAPON SYSTEMS

Main Armaments:

Electro-Magnetic Fission Beam (1)
Particle Beam Cannon (30)

Secondary Armaments:

High-Powered Laser Cannons (60)
Light Laser Cannons (400)
Missile Turrets (100)

- 1. Electro-Magnetic Fission Beam:** (very similar to the SDF-1's main gun) This is the most devastating of the weapon systems, virtually obliterating everything in its path. To fire, the mothership needs five minutes (20 melees) to power-up, then one minute (4 melees) before it can fire. The beam lasts one full melee (15 seconds), cutting a swath approximately two miles (3.2km) wide and 100,000 miles (80,000km) long. The massive amounts of focused energy required for the beam restricts the number of attacks to once every eight minutes (32 melees).

Primary Purpose: Assault/Anti-Planet

Secondary Purpose: Anti-Warship

Mega-Damage: Destroys EVERYTHING in its path of fire regardless of M.D.C. Against a planet, it inflicts approximately 4D6 × One million M.D., leaving a massive, smoldering crater measuring 2D4 × 10 miles round and 6D6 × 100 feet deep.

Range: 100,000 miles (double in space).

Rate of Fire: Once every eight minutes (32 melees).

Payload: Unlimited

- 2. Particle Beam Cannons** are scattered across the mothership.

Primary Purpose: Assault

Secondary Purpose: Anti-Warship/Anti-Planet

Mega-Damage: 1D4 × 1000

Range: 100,000 miles (double in space)

Rate of Fire: Once every other melee.

Payload: Unlimited

3. High-Powered Laser Cannons are scattered through the hull of the ship, top, bottom, sides and rear. They are hidden beneath a sliding hatch until needed for combat, when they rise up from their weapon bay to assail an enemy. The Laser is capable of a 180 degree arc of fire.

Primary Purpose: Assault

Secondary Purpose: Anti-Warship/Anti-Planet

Mega-Damage: 2D4 × 100 each. A turret can be fired individually or combined with others in a simultaneous volley.

Range: 100,000 miles (almost double in space).

Rate of Fire: Each turret can fire *twice* per melee in any combination of volleys; minimum per volley is 3.

Payload: Unlimited

4. A Battery of Light Lasers are scattered in the front, and along the sides and bottom of the *forward section*. Individually, they are the least impressive armaments on the vessel. Firing simultaneously in a volley of a dozen or more beams, they are devastating.

Primary Purpose: Assault/Defense

Secondary Purpose: Anti-Warship

Mega-Damage: 1D6 × 20 each. Several lasers can be directed to fire in volleys of 3 or more. Mega-damage by volleys: three beams inflict 3D6 × 20, six beams — 6D6 × 20, nine beams — 9D6 × 20.

Range: 30 miles (48.2km)(double in space).

Rate of Fire: Each laser can fire once per melee, and can be combined in any volley combination. *For example:* A ship with 24 light forward lasers could fire two volleys of NINE laser blasts and one volley of SIX laser blasts, or eight volleys of THREE laser blasts or four volleys of SIX laser blasts and so on. ***EACH VOLLEY CAN BE DIRECTED AT A DIFFERENT TARGET OR THE SAME TARGET.***

Payload: Unlimited

5. Missile Turrets, like the lasers, lay hidden beneath inconspicuous hatches until called forth for battle. They are capable of 360 degree rotation with a 90 degree arc of fire.

Primary Purpose: Assault

Secondary Purpose: Anti-Warship

Mega-Damage: Varies with each particular type of missile launched.

They are as follows:

Medium Range Missiles

1. High Explosive: 2D6 × 10 M.D.; range — 60 miles (80.4m)

2. Plasma/Heat: 3D6 × 10 M.D.; range — 60 miles (80.4m)

Long Range Missiles

1. High Explosive: 3D6 × 10 M.D.; range — 1800 miles (2893km)

2. Plasma/Heat: 4D6 × 10 M.D.; range — 1800 miles (2893km)

3. Reflex (heavy): 4D6 × 10 M.D.; range — 2000 miles (3214.8km)

Blast Radius: 50ft (15.2m) — medium; 80ft (24.4m) — long range.

Range: Varies with missile type as noted.

Increase the missile's range by 60% when launched in outer space. Typical missile speed is 1800mph.

Rate of Fire: Each missile turret can fire once per melee and can be combined as a volley. The minimum number of missiles in a volley is 10. A barrage of missiles, *randomly fired*, can also be launched.

Payload: Effectively Unlimited

Fortunately for Earth and her defenders, the Robotech Masters' ships are nearly depleted of all energy reserves. The electro-magnetic fission beam can only be fired once. The particle beams are shut down completely leaving, approximately, 20 high-powered laser cannons functioning at half range, 200 Light Lasers also at half range, and 12 missile launchers still operable.

The Robotech Masters' mothership normally has a **directional force field** that is reminiscent of the SDF-1 pinpoint barrier system.

Maximum Size: 300ft radius (91.5m)

M.D.C.: 500

Normal Bioroid Complement: 14,400 Standard Bioroids

1200 Leader Bioroids

Invid Fighters as needed

RANDOM ENCOUNTERS INSIDE THE ROBOTECH MASTERS' MOTHERSHIP

- 1-10 Three scientists accompanied by 1D4 terminators; scientists will flee while terminators fight till the death.
- 11-16 Surveillance monitor; unless destroyed within two melees it will alert Robotech Masters.
- 17-22 Electro Assault Hose: Fires an electro beam that inflicts 1D4 M.D., Range: 8ft (2.4m); has 1 M.D.C.
- 23-27 Surveillance monitor; unless destroyed within two melees it will alert Robotech Masters.
- 28-35 1D4 Green Standard Bioroids; hostile, attack immediately.
- 36-44 1D4 Worker Bioroids ignore intruders and keep on working. If attacked, the Clone Masters will be alerted to the presence of intruders and send one of the following: One terminator for every foot soldier seen, or one standard Blue Bioroid for every mecha seen plus one Red Leader Bioroid.
- 45-53 2D4 Blue Bioroids and one Red Leader; hostile, attack and fight to the death.
- 54-63 A chamber guarded by 2D4 Terminators. Unless incapacitated within 6 melees, they will alert ship defenders bringing on 2D6 Terminators and 1D4 + 2 Blue or Green Bioroids.
The adjoining chamber is one of the following:
1-25 Clone Chamber: 1D6 scientists and 2D4 more Terminators inside.
- 26-50 Bioroid Construction Facility: 1D4 Terminators and 1D4 Bioroid Workers inside; all will fight to the death.
- 51-75 Laboratory: 40% chance of a scientist being present; will try to escape or sound alarm.
- 76-00 Meeting or Lounge Area: 2D6 Tyrolian citizens are present. All are scared and unarmed; will try to flee.
- 64-71 Electro Assault Hoses: Each fires an electro beam inflicting 1D4 M.D.; two attacks per melee, each hose has a M.D.C. of one.
- 72-81 1D4 + 2 Green Bioroids on patrol. Will immediately alert the Clone Masters (who see what they see) and attack. All will fight to the death unless telepathically told otherwise.
- 82-89 Surveillance camera hidden among the debris of a cluttered wall. There is only a 30% chance of somebody spotting it. If not destroyed within 4 melees (one minute) it will notify Clone Masters or Robotech Masters. One Blue, Standard Bioroid will be dispatched for every intruder seen, plus one Green and Red Leader Bioroid. Combat will be monitored and reinforcements sent, if they are needed.
- 90-94 Terminator Sniper: Gets a free shot at any one target (has initiative). Players lose one attack while scrambling for cover and looking for sniper. Only a 19% chance of seeing him until he fires a second time. Will fight to the death.
Main group of Standard Bioroid; out numbers the players 2 to 1. Fight to the death.
- 95-00 Invid Fighters: One set of triplets per every two player characters. Watch out!

SOUTHERN CROSS AND THE WORLD

The world has changed a lot over the last fifteen years since the end of the *First Robotech War*. The rogue Zentraedi which once dominated the South American Sector and plagued the world, have been destroyed through a series of tragic wars. The *Robotech Defense Force* (RDF) has flown to the stars in search of the Robotech Masters. With them their famous mecha, the loyal Zentraedi and the legendary SDF-3. Except for a few RDF bases manned by skeleton forces and 20 year old Destroids, the protection of the Earth is left to the Armies of the *Southern Cross*.

The Southern Cross is an international protection agency dedicated to the defense of the entire planet. As such, it is not allied to any one nation or kingdom. To emphasize its autonomy and purpose, its name is taken from the constellation where the Robotech Master's homeworld, Fantoma, is located, the constellation known as the "Southern Cross".

To understand the Southern Cross, you must understand this future Earth. Wastelands cover half the world as mute testament to the destruction of the First Robotech War. The old power structures toppled as entire nations were obliterated by the Zentraedi onslaught. In a matter of minutes, all of Western Europe, the Middle East, and much of the Earth, was razed to the ground. No buildings, no refuge no life. Totally and completely annihilated. Earth would be forever changed.

With the help of the courageous men and women of the RDF, the survivors began to rebuild. But the old ways, the old *boundaries*, were gone. The United States, Canada, Britain, Soviet Union were empty, meaningless words. Ghosts of a past that would never be again. Yet out of the ashes of the old world rose a new one. Effectively, a completely different world *without* boundaries or nations. For that matter, a world without law. At first, survival alone would consume man, but soon he would conquer his environment and establish his territories. Like the ancient pioneers conquering the new world, communities, towns and cities grew. New boundaries established, new claims on land, and resources. New territories, kingdoms and nations. As might be expected there are many *disputes* regarding these claims. Then there are those who, having conquered their own land, look to their neighbor's and want it. Thus, the world is wracked in dispute and civil unrest. Like the feudal days of old, the weak pledge allegiance to the strong in return for protection. The new cities and nations are more like kingdoms, with dozens of smaller, warring communities within their disputed territories.

The level of civil unrest varies greatly from place to place. Some are extremely well established power bases with peaceful orderly towns and citizens. Others are in the throes of turmoil, trying to build an empire or just holding on to what it has through war. Others use technology or resources to blackmail their fellows into submission or collusion. Others are huge and powerful, like the E.B.S.I.S., or too insignificant to notice.

The original United *World* Government has crumbled into dust, but a new organization, The *United Earth Government* (U.E.G.), has taken its place as sort of a United Nations or labor union; collating data, suggesting trade agreements, recognizing official boundaries, trading technology, and most importantly, maintaining global communication. The Southern Cross often works in conjunction with the UEG, trading information, facilities, and taking advantage of its global communication network. However, the world is still divided into many distinct territories and kingdoms, with dozens or even hundreds of smaller, warring, feudal communities within each.

The Southern Cross is a part of this broken world, where brother claws at brother to build his own domain. It is the only force capable of defending the world from alien aggression (which is fearfully anticipated), as well as maintaining a certain code of combat among the

warring kingdoms to prevent self inflicted nuclear obliteration. This gives the Southern Cross a great deal of political leverage. Much like feudal Germany, most of the kingdoms have acknowledged the Southern Cross as their protector and have pledged fealty to the Army. Each acknowledges the Southern Cross as an autonomous military power dedicated to preserving *ALL* the kingdoms of the world without favoritism. To avoid association with any one specific nation, the Southern Cross has its own land or kingdom (the Army views it as a world headquarters), with armies scattered around the world. The mecha, weapons and robototechnology of the Southern Cross are theirs alone; to be used to protect the world, but not shared with its nations. The individual nations are united in support of this global defense force by providing raw materials, manufacturing, man power, cooperation, and other resources.

THE MERCHANT REPUBLIC

The United Earth Government continues to crumble as new factions splinter from the one global government to form independent nations and kingdoms. One of the most unusual and powerful kingdoms is the *Merchant Republic*; a criminal network of high-tech bandits which has prospered and grown out of the *Argentine Quadrant*. Once the international Zentraedi buffer zone, every sector, quadrant and nation in the world had established an embassy and army in the Argentine Quadrant. This potpourri of peoples, mercenaries, wealth, technology and activity created a thriving no-man's zone of villainy and virtue. A twisted blend of man's protectors and parasites. The Argentine Quadrant rapidly became the world leader in high-tech piracy and black marketing, specializing in mecha. After all, the South American jungles were alive with RDF and Zentraedi mecha and equipment. Not to mention a constant infusion of weapons, equipment and monies which were child's play to divert to more personal interests. However, with the final end of the Zentraedi conflict in the year 2020, prosperity turned to despair. Suddenly, foreign aid disappeared, embassies closed and the RDF withdrew.

The Argentine Quadrant was quickly becoming a ghost town when the most powerful criminal kingpins formed a coalition and declared the Argentine Quadrant to be the new independent nation, the Merchant Republic. Despite strong opposition and political outcry against the infamous, criminal rulers of the Merchant Republic, none could prevent its existence. The RDF had its hands full with policing the world and preparing for their sojourn into space. The Southern Cross was still a fledgling organization, struggling with its own birth pangs. The E.B.S.I.S. instantly recognized and supported its old, black market ally (and still main supplier of mecha and technology). Other countries and kingdoms were coerced to support the new nation, for the Merchant Republic still supplied many of them. New, unstable kingdoms that could not afford to sever their life line to technology were also quick to acknowledge the Republic. Military aggression was pointless against a power that supplied much of the world and kept the best for themselves. Within a month, the Merchant Republic was grudgingly recognized as an independent nation.

The Merchant Republic is the weapons broker of the new world. They sell and trade arms, vehicles, manpower, and other forms of technological assistance, to the many fragmented and warring feudal states. They are moral brigands who thrive on the adversity of others. The Merchant Republic services the North and South American Sectors, as well as the E.B.S.I.S. It has few ties to the East. **Note:** Tech level is high — about 1996 level.

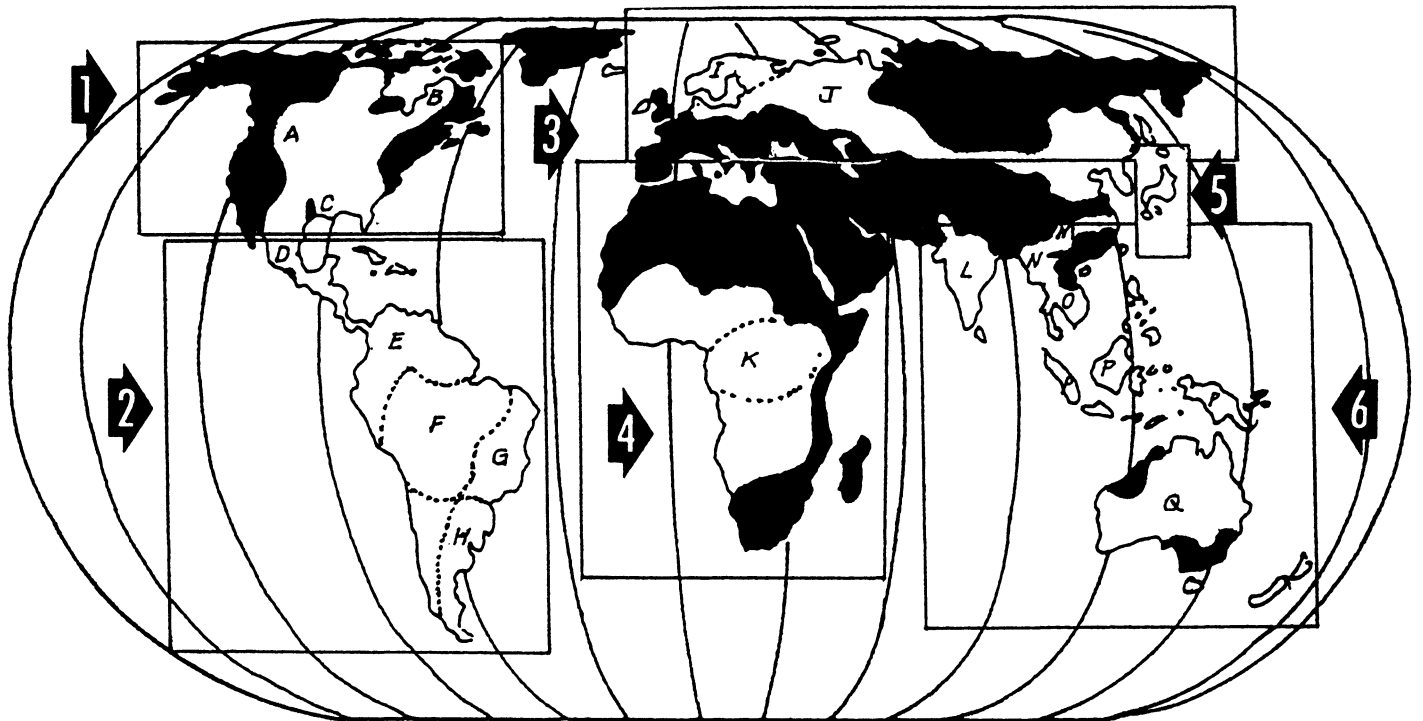

A GLOBAL SUMMARY CIRCA 2030

THE SECTORS

1. The North American Sector

Includes Canada and the U.S.A. Scattered communities with major industrial clusters.

2. The South American Sector

Mostly jungle with pockets of civilization. The rogue Zentraedi which once terrorized the land are believed to have been completely eliminated.

3. The Northern Euro Sector

It includes the Scandinavian countries and the E.B.S.I.S. The black areas of the map represent wastelands, although efforts are being made to reclaim some of it.

4. The Africa Sector

In recent years, it has been the site of combat and turbulence. It was here that the last, major, Zentraedi confrontation began. Still mostly unpopulated jungle and wasteland.

5. The Far East Sector

The Robotech Research Center is located in the Japan Quadrant and remains the most populated and technologically advanced sector in the world.

6. The Eastern Sector

Includes, India, China, Indonesia and Australia.

THE MAJOR QUADRANTS AND HIGHLIGHTS

- A. Monument City, headquarters of the Southern Cross Defense Force.** It is also the site of the SDF-1 and the major area of confrontation against the Robotech Masters.
- B. Quebec Quadrant:** An independent nation with newly discovered mineral resources.
- C. The Arkansas Protectorate:** The Zentraedi have been destroyed and the Protectorate placed under human jurisdiction. It is currently an agricultural center.
- D. Mexico Quadrant:** Widely populated and unchanged over the years. It is the home of the RDF and Southern Cross.
- E. Venezuela Quadrant:** Modest population; predominately farmland.
- F. The Zentraedi Control Zone:** A dense jungle area following the Amazon River. It has been liberated from the maniacal Zentraedi rogues which once ruled the land and is now called Zone-Z. It is suspected that some Zentraedi may remain hidden in the tropical forests, but none are known to exist. *The Southern Cross Jungle Squad* routinely patrols the area.
- G. The Brazilia Quadrant:** Scattered population with some major industrial facilities, and *Southern Cross Jungle Squad* and air force (T.A.F.) bases.
- H. The Argentina Quadrant:** The site of the New Merchant Republic government. It is the black market capital of the world.
- I. The Scandinavia Quadrant:** Includes Norway, Sweden, Finland and Denmark. This Quadrant was, remarkably, untouched by the Zentraedi assault in the First Robotech War and has become the seat of the United Earth Government. Industry and technology levels

WORLD MAP SHOWING MAJOR MILITARY INSTALLATIONS

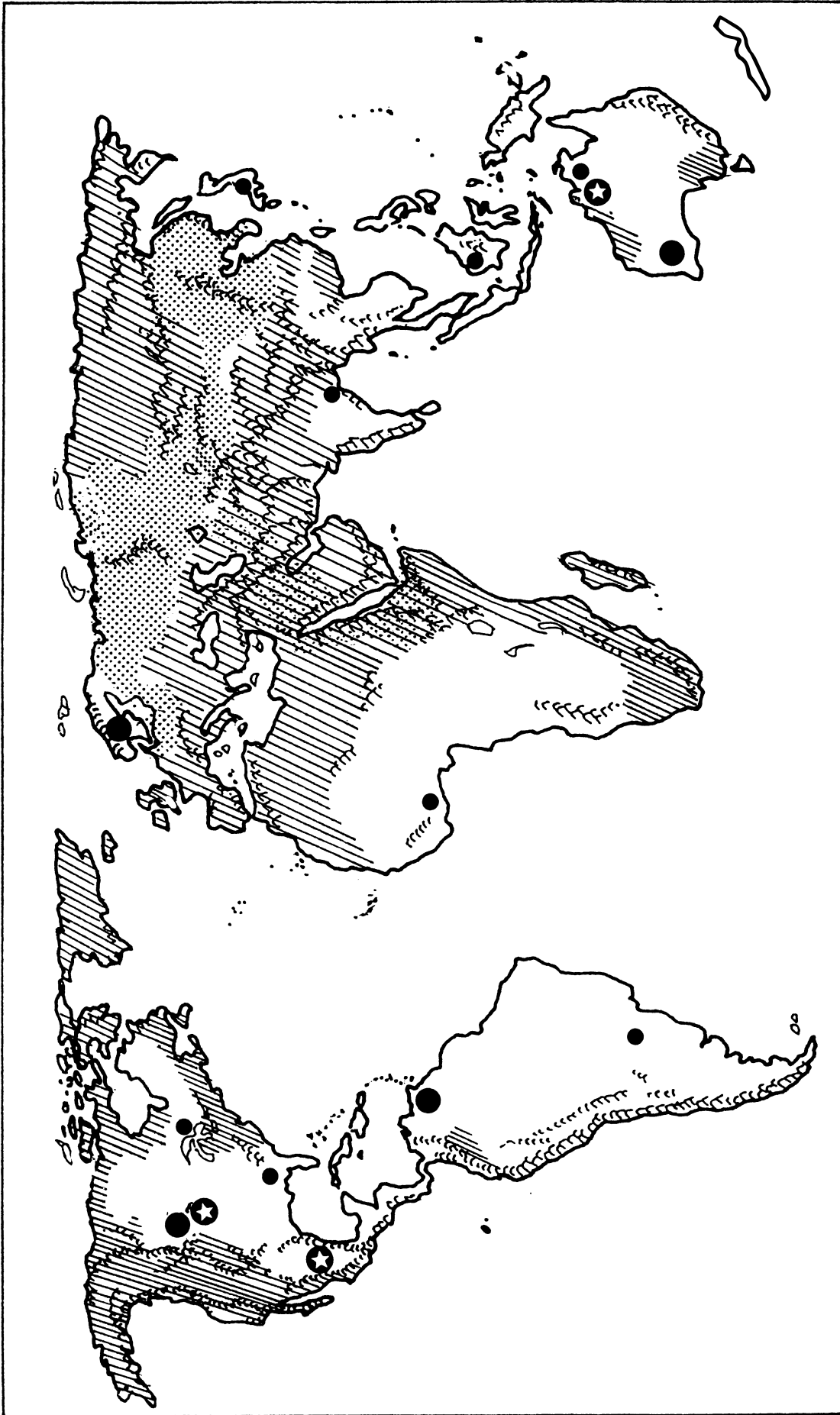

● Major Bases for the Armies of the Southern Cross. Monument City in the North American Sector is the World Headquarters. The Southern Cross has taken over the old RDF New Alburquerque Base and Brazilia Base, and share the Yellowstone Base. Two new bases have been built near the New Arkansas Protectorate and another near the Quebec Quadrant. The Secondary Southern Cross Command Center is located in the Scandinavia Quadrant near the United Earth Government Headquarters.

★ The last three RDF Bases: Yellowstone in North America (it is shared with the Southern Cross), The Mexico City Base and the Dundee Australian Base.

▤ E.B.S.I.S. Territory

▨ Wasteland from the First Robotech War. These areas are hostile expanses of grasslands, deserts and charred earth. It is only now beginning to show signs that it can again support human life.

THE ROBOTECH® CHARACTERS

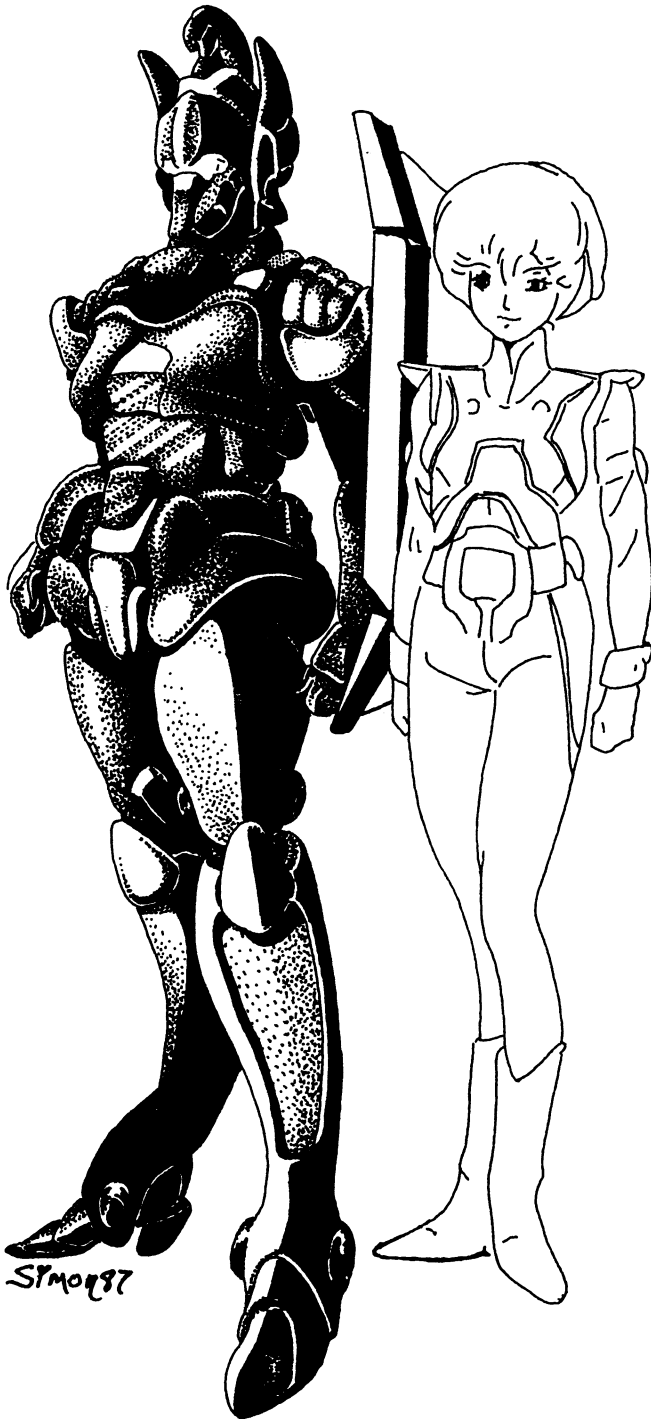

DANA STERLING

Commander of the 15th A.T.A.C. Squadron

Pilots a Hover Tank

Hit Points: 32 **S.D.C.:** 42

Alignment: Unprincipled

Attributes: I.Q. 15, M.E. 12, M.A. 13, P.S. 15, P.P. 20, P.E. 14, P.B. 10, Spd. 12

Age: 18 at the beginning of the series, 19 at its end.

Weight: 120lbs **Height:** 5ft 8in.

Disposition: A natural leader, energetic, cheerful, clever; always willing to take the initiative. A little insecure because of her young age, her Zentraedi heritage and the shadow of her two heroic parents, Max and Miriya Sterling.

Level of Experience: 4th level A.T.A.C. O.C.C.

Skills: Pilot Veritech Hover Tank — 82%, Mecha Combat: V.H.T., Pilot Hover Cycle — 86%, Weapon Systems — 98%, Read Sensory Instruments — 75%, Navigation — 90%, Hand to Hand: Expert, W.P. Energy Pistol, W.P. Energy Rifle.

M.O.S. Skills: (Combat): Climbing — 82% (rappelling — 50%), Gymnastics (Prowl — 50%), Swimming — 82%, Boxing, W.P. Sub-Machinegun, W.P. Automatic Pistol, W.P. Blunt.

Other Skills: Radio: Basic — 70%, Cook — 82%, Math: Basic — 96%, Computer Operation — 80%, Demolitions — 80%, Demolitions Disposal — 80%, Pilot Automobile — 96%, Pilot Truck — 82%.

Rank: Lieutenant

Personal Profile: Dana is the daughter of Max and Miriya Sterling, two of the heroes of the First Robotech War. This heritage has deeply affected Dana for several reasons. First, she is the first child of a highly publicized union between human and Zentraedi. The fear and hatred of Zentraedi, even half human, half Zentraedi, has followed her all her life. Second, Dana lives in the heroic shadows of her parents, both Veritech Fighter aces, and heroes loved throughout the world. She feels she must prove that she is as capable a fighter and pilot as both of her parents. Lastly, Dana is alone. Max and Miriya have left Earth nearly a decade ago with Rick Hunter and the SDF-3, leaving Dana in the capable hands of her godfather, General Rolf Emerson. She thinks of her parents often and longs for their return.

Dana Sterling is among the first graduates of the Robotech Military Academy, ranking highly in her class as Veritech Hover Tank pilot. She possesses a genuine innocence and a curious mind, ever observant, and inquisitive. Dana is an athletic, selfreliant warrior with an outstanding sense of timing and intuition. She is a fine leader, who is always ready to back up her words with action.

BOWIE GRANT

Soldier in the 15th A.T.A.C. Squadron

Pilots a Veritech Hover Tank

Hit Points: 24 **S.D.C.:** 40

Alignment: Unprincipled

Attributes: I.Q. 13, M.E. 8, M.A. 9, P.S. 13, P.P. 14, P.E. 10, P.B. 14, Spd. 12

Age: 18 at the beginning of the series, 19 at its end.

Weight: 122lbs **Height:** 5ft 4in.

Disposition: Sensitive, soft-spoken, nice guy; friendly, courteous and hospitable.

Level of Experience: 3rd level A.T.A.C. O.C.C.

Skills: Pilot Veritech Hover Tank — 79%, Mecha Combat: V.H.T., Pilot Hover Cycle — 82%, Weapon Systems — 95%, Read Sensory Instruments — 90%, Navigation — 85%, Hand to Hand: Expert, W.P. Energy Pistol, W.P. Energy Rifle.

and Musika to *desert* their posts in an attempt to avoid the insanity of war.

ANGELO DANTE

Sergeant of the 15th A.T.A.C. Squadron
Pilots a Veritech Hover Tank

Hit Points: 39 S.D.C.: 42

Alignment: Scrupulous

Attributes: I.Q. 10, M.E. 9, M.A. 8, P.S. 19, P.P. 15, P.E. 14,
P.B. 12, Spd. 10

Age: 26 at the beginning of the series, 27 at its end.

Weight: 210lbs Height: 6ft 8in.

Disposition: Gruff, grumpy, tough-guy; has a grudging respect for his commander, Dana Sterling.

Level of Experience: 6th level A.T.A.C. O.C.C.

Skills: Pilot Veritech Hover Tank — 88%, Mecha Combat: V.H.T., Pilot Hover Cycle — 94%, Weapon Systems — 98%, Read Sensory Instruments — 85%, Navigation — 98%, Hand to Hand: Expert, W.P. Energy Pistol, W.P. Energy Rifle.

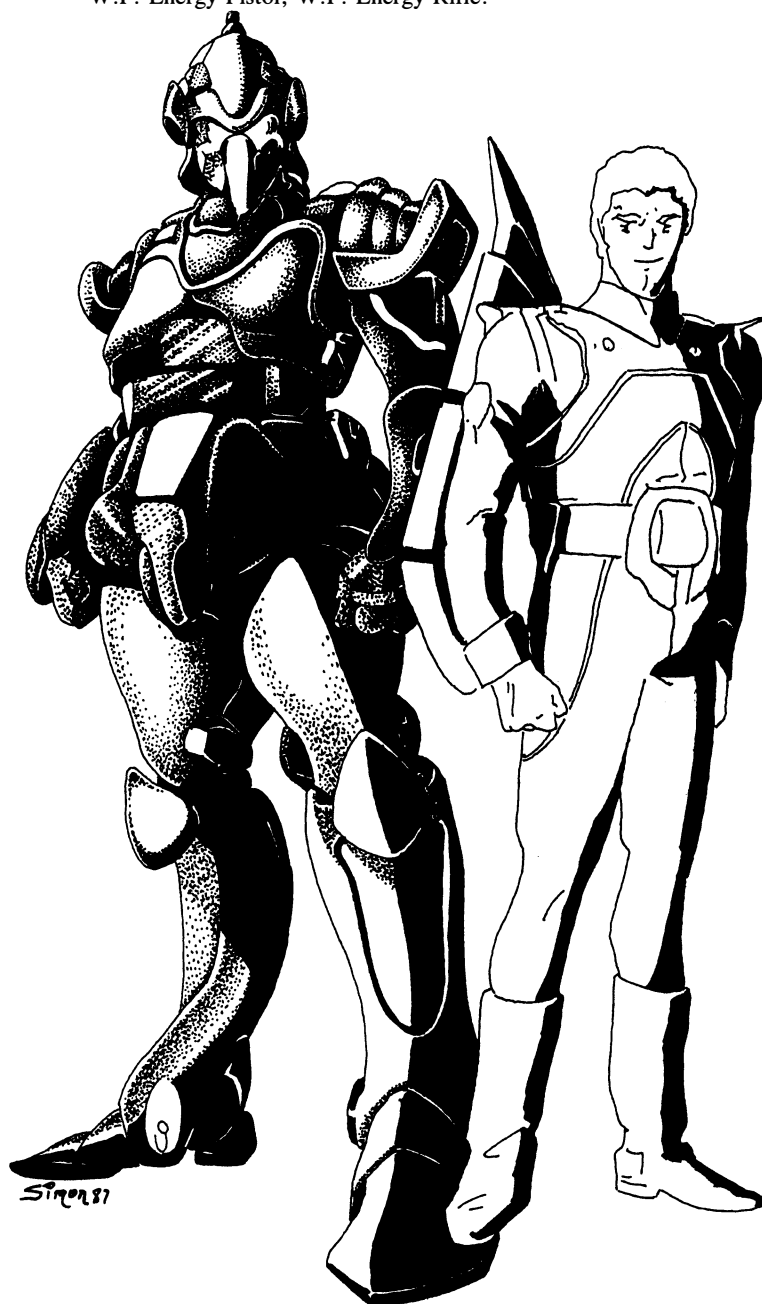
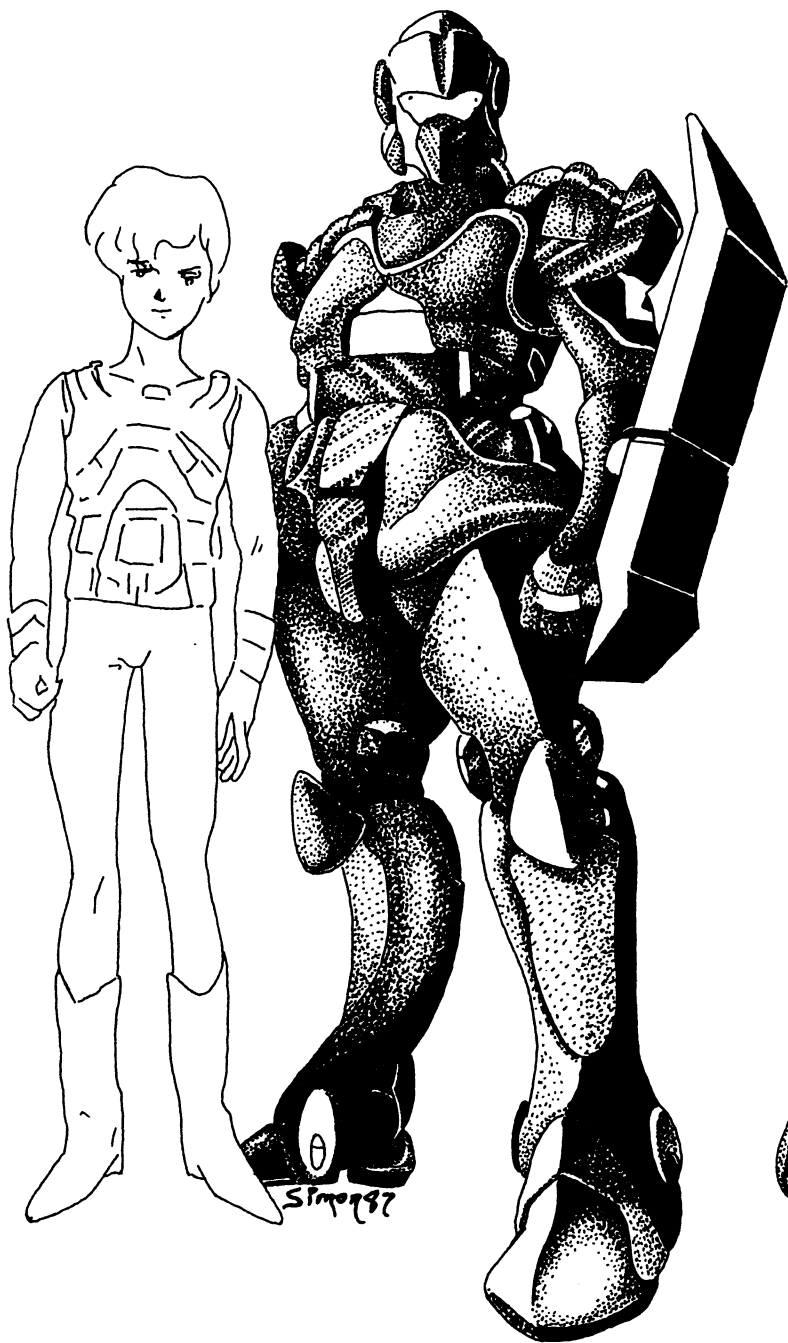

M.O.S. Skills: (Communication): Radio: Basic — 85%, Radio: Scrambler — 75%, Optic Systems — 85%, T.V./Video — 75%, Cryptography — 65%.

Other Skills: Sing, First Aid — 78%, Computer Operation — 75%, Math: Basic — 92%, Math: Advanced — 76%, Pilot Automobile — 92%, Pilot Truck — 78%, Boxing.

Rank: Private

Personal Profile: Bowie Grant is the gentle, introspective nephew of the late Claudia Grant. He is a sensitive, soft-spoken youth who has yet to find his place in the world. Like his childhood friend, Dana Sterling, his parents left him in the custody of his godfather, General Emmerson, while they joined the forces of the SDF-3 on their sojourn to the stars. Bowie and Dana are like brother and sister. When Dana entered the service, Bowie tagged along and eventually became her aid in the 15th squadron. Bowie is a skilled fighter, although he has no love for war or even physical sport. His true interest is in music. Bowie is a gifted piano player and fair singer. With this in mind, it seems no wonder that he finds himself attracted to the alien, *Musika*. A mutual attraction that causes both Bowie

M.O.S. Skills: (Weapons): Sniper (+3 to strike with a rifle; aimed shot), W.P. Heavy, W.P. Sub-Machinegun, W.P. Semi & Full Automatic Rifle, W.P. Automatic Pistol, W.P. Blunt, W.P. Knife.

Other Skills: Radio: Basic — 80%, Auto Mechanics — 80%, Pilot Automobile — 98%, Body Building.

Rank: Sergeant

Personal Profile: “Angie” is a rustic, down to earth character who comes from the old school where might usually meant right. Angelo remembers the final days of the First Robotech War, and grew up with the Zentraedi conflicts and terrorism of the decade following the war. Consequently, he is bitter and suspicious of Zentraedi, interracial marriages/children and aliens in general. He also tends to be chauvinistic toward women. Yet despite these prejudices, Sgt. Dante is a loyal, dedicated soldier who can put aside his differences and operate as an efficient team member.

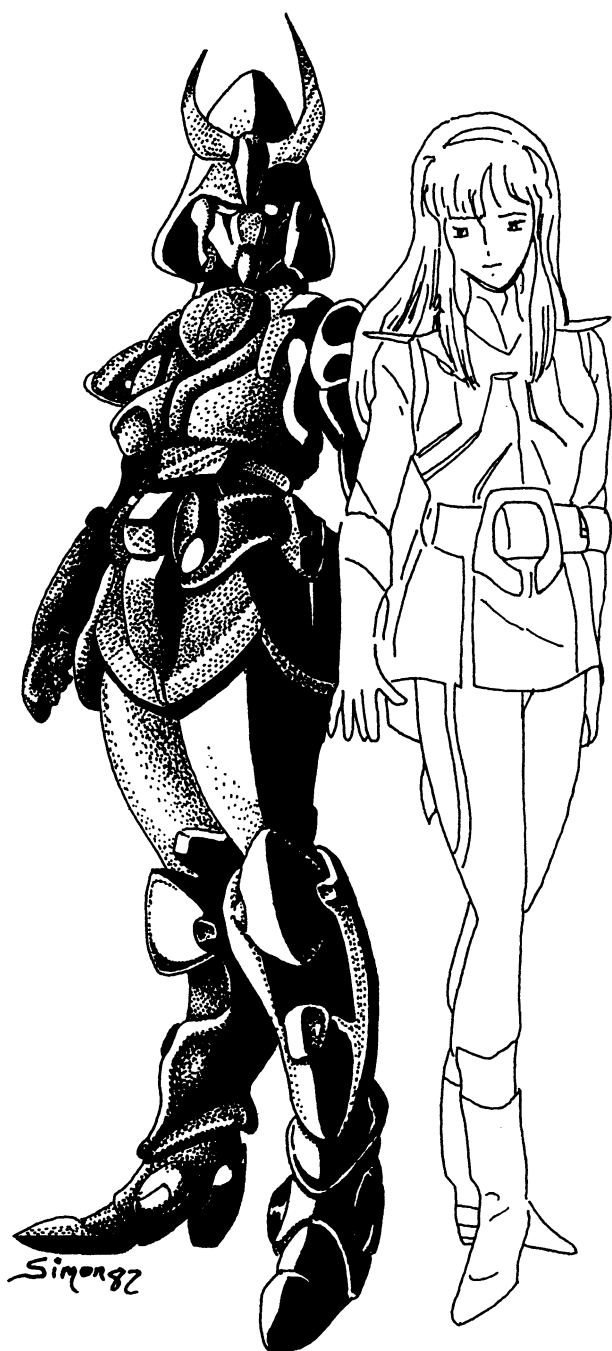

NOVA SATORI

Officer in the Global Military Police (G.M.P.)

Hit Points: 30 **S.D.C.:** 40

Alignment: Anarchist

Attributes: I.Q. 14, M.E. 13, M.A. 15, P.S. 14, P.P. 17, P.E. 11, P.B. 14, Spd. 11

Age: 20

Weight: 135lbs **Height:** 5ft 11in.

Disposition: Tough, cold, self-reliant, cocky, a lone wolf; clever, tricky and a fairly good tactician.

Level of Experience: 4th level G.M.P. O.C.C.

Skills: Surveillance — 70%, Intelligence — 85%, Interrogation — 66%, Land Navigation — 65%, Pilot Automobile — 96%, Hand to Hand: Martial Arts, W.P. Energy Pistol, W.P. Energy Rifle.

M.O.S. Skills: (Military Intelligence): Escape Artist — 85%, Forgery — 65%, Disguise — 85%, Pick Locks — 70%, Pick Pockets — 65%, Tracking — 70%.

Other Skills: Basic Electronics — 60%, Optic Systems — 75%, Radio: Basic — 75%, Radio: Scrambler — 65%, Prowl — 70%, Body Building, Pilot Hover Cycle — 70%, Read Sensory Instruments — 60%, Computer Operation — 80%, W.P. Automatic Pistol.

Rank: Lieutenant

Personal Profile: Nova has proven herself a superior G.M.P. officer, which has garnered her the distinction of being the highest ranking female officer in the G.M.P. She is devoted to her duty, tries to live by the “rules”, and is obsessed with carving a better world out of the ashes of the First Robotech War. Nova maintains a cold outer shell, never letting anybody get close to her. She finds Dana Sterling’s carefree attitude and disposition inappropriate for an officer, and is envious because Dana can show her emotions so easily. It is a cavalier attitude Nova can not afford, for her devotion to duty often causes her to betray friendship for the “betterment of the people”.

Nova has the thankless job of trying to glean information from captured prisoners and spies, as well as assisting in security at Monument City. Her most challenging case comes from the investigation of the enigmatic alien, Zor.

ZOR PRIME (Clone)

Leader Bioroid Pilot

Hit Points: 48 **S.D.C.:** 30

Alignment: Unprincipled

Attributes: (*Many stats are unusually high because this is a clone from the original, brilliant Robotech scientist*). I.Q. 22, M.E. 19, M.A. 17, P.S. 18, P.P. 20, P.E. 14, P.B. 14, Spd. 15

Age: Undetermined; appears about 25.

Weight: 180lbs **Height:** 6ft 4in.

Disposition: Distant, full of thought, intense, extremely cunning, quick thinker.

Level of Experience: 6th level.

Skills: Hand to Hand: Expert, Pilot Bioroid, Bioroid Combat, Pilot Bioroid Hover Craft — 90%, Prowl — 80%, W.P. Blunt, W.P. Automatic Pistol, W.P. Energy Pistol, W.P. Energy Rifle. **Note:** The memories of the original Zor, the scientist are lost.

Rank: Lead Bioroid pilot and chief pawn of the Robotech Masters.

Personal Profile: Zor is a clone created by the Robotech Masters from the genes of the original Zor, the father of Robotechnology. It was one, last, desperate bid to regain the lost secrets of that forgotten science. However, the mysteries of protoculture died with the original Zor.

Unable to retrieve the precious information from the clone’s memory, the Robotech Masters interweave him into a plot of subterfuge.

JAPANAMATION NOTES

The Logan Veritech Fighter

1) The Japanese name is definitely *Logan*, but it is also referred to as the "Flying Cat" in jet mode, and "Flying Walker" in guardian/ger-walk mode. 2) Type: TASC-02-SCF seems to refer to the specific Army Corps. 3) All weapons appear to be projectiles rather than energy.

The AJACS Hover Helicopter

1) The Japanese name is Auroran. 2) Type TASC-02-SCF.

The Veritech Hover Tank

1) The Japanese name is Spartas. 2) Type ATAC-01-SCA.

Non-Transformable Battloids

There is no real data on any of these devices. The abilities described in this book are pure speculation based upon multiple view drawings from the original animation model sheets. Only the Mecha we call the *G.M.P. Battloid*, (seen in episode 41) *T.C. Recon and Civil Defense Battloids*, (all seen in episode 46) are actually shown in the American Robotech T.V. series. These appearances are incredibly brief and reveal nothing other than that they stand as tall as the V.H.T. in Battloid mode.

I have been informed that the Southern Cross animated series was originally supposed to be much longer than it is, but that the series was cut short by something like 20 episodes. Perhaps some of these other mecha designs never saw life on film. Or perhaps they were purely pretty backdrop elements that were edited out for American T.V. At any rate, we bring them to some sort of life here, in the pages of our RPG.

The **E.B.S.I.S. Battloids** are also based on existing model sheets of unknown mecha. Our research has indicated the Soviet *Soldier Battloid* was probably another type of underwater battle armor and not a mecha at all. *The Juggernaut* is of similar design, so it *may* also have been intended as battle armor, not mecha. It is interesting to note that the *Starblaze edition of Robotech Art One* mistakenly identifies this design as a "non-combatant Bioroid worker."

The Bioroids

All, except for the worker, are seen at some time during the 26 episodes of the Southern Cross segment of the Robotech Series.

Note: Most of the information provided in this book is specifically from the original animated series. This includes the guns, back packs, utility belts, body armor, vehicles, battloids, bioroids and armies. The descriptions are derived from lengthy meetings with Carl Macek at Harmony Gold, Japanese translations and over 200 hours of observing the T.V. series.

Japanimation Tip: The entire issue of "This is Animation #10" is devoted entirely to Southern Cross. Unfortunately, this is a difficult Japanese book to find and the information is minimal. Great pictures though.

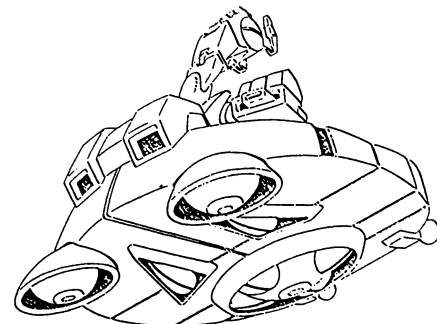

They allow Zor's capture by the humans and monitor everything Zor experiences through an implant in his brain. However, the plan backfires when their witless spy becomes obsessed with destroying the entire Robotech Masters' society. The course of events which follow sabotage the Masters and help lead to their destruction at the hands of the suicidal Zor. His plan to explode the Masters' mother-ship above the site of the SDF-1 to destroy the budding Invid Flower of Life, as well as the Robotech Masters, only accomplishes the latter.

Hundreds of thousands of seeds from the germinating Flowers of Life are scattered to the wind, fall to earth and take root. Zor's self-sacrifice saves the Earth from the Robotech Masters, but condemns it to the *Invid*.

Note: The third part of the Robotech saga: *The Invid Invasion* (originally entitled Mospeada) will appear in Book 5 of the continuing RPG series in the Spring of 1988.

CHARACTERS AND RANK

Presumably, most GMs will have the player characters assigned to their own team or squad. This means a leader must be selected. To avoid hurt feelings, I suggest the players democratically choose a player whose character will be the acting leader. This character is immediately given the rank of Corporal (pending sergeant if he/she proves to be a sound leader), while the rest of the characters remain privates 1st class. After the first 3D4 weeks in the field . . . or . . . after the group has been noted for outstanding action (acts of extreme heroism, valor, a major crime busting operation, or some other *impressive* accomplishment), the characters should all receive promotions to the next rank; sergeant for the team leader and corporal for all the others. Awarding promotions should slow down from this point on. The GM may use the experience point system of major accomplishments to help him fairly consider promotions in ranks.

Some Rules of Thumb Regarding Rank:

1. Most characters are never likely to attain a rank beyond Sergeant Major.
2. There can be many Corporals or even Sergeants in a Mecha Team, but only ONE Captain, 1st Lieutenant, 2nd Lieutenant and Sergeant Major.
3. The squad leader can be one rank below the highest ranking officer in the team if he has more combat experience.
4. Specially assigned officers must bow to the team leader regardless of superior rank.
5. The highest possible rank for a Mecha Team, squadron/team leader is usually Major, although Captain is the norm.
6. Rank higher than a major usually means an administrative position at a military base or outpost.

RANKS, from the highest to the lowest

General	Second Lieutenant
Lieutenant General	Sergeant Major
Major General	Master Sergeant
Brigadier General	Sergeant First Class
Colonel	Staff Sergeant
Lieutenant Colonel	Sergeant
Major	Corporal
Captain	Private First Class
First Lieutenant	Private

Robotech® RPG

Based on the animated TV series that has thrilled generations

The Robotech® RPG and sourcebooks in this series are ALL completely new and rewritten. They are NOT reprints of the Robotech® titles from the 1980s and 1990s. Each contains new rules, stats, descriptions, characters, and a wealth of new information!

Based on the fan-favorite television show, the Robotech® RPG enables players to experience adventures in any or all eras and generations of the Robotech® saga. Fast character creation and anime action.

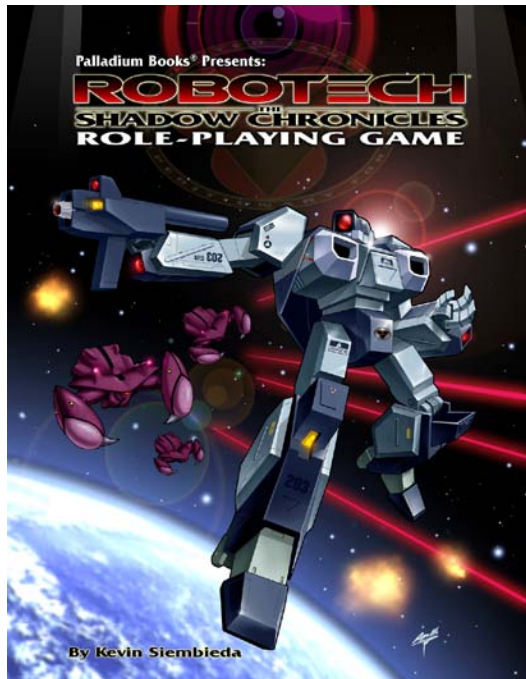

Robotech®: The Shadow Chronicles® Hardcover RPG

The core rule book, it contains everything you need to play except imagination, dice and friends. Newcomers to the Robotech® saga will be able to quickly understand and play the game without ever having seen the television series.

The Shadow Chronicles® RPG presents the forces of the United Earth Expeditionary Force (UEEF) and its combat mecha, including Veritech Fighters, Alphas, Betas, Cyclones, and more. The enemy is the Invid and the traitorous Haydonites. Based on the popular Robotech® television series. Illustrated throughout.

- Core rule book, Invid and Shadow Chronicles space setting.
- Haydonites, the Wraith, Infiltrator and spaceships.
- 8 Invid mecha, plus the Invid Carrier.
- 16 UEEF mecha, including the Bioroid Interceptor, Condor, Alphas, Betas, Super Cyclone, Silverback, and more.
- UEEF weapons, Synchro Cannon, vehicles, spaceships and gear.
- Space combat rules, missiles and more.

- O.C.C.s include the Battloid Ace, Veritech Fighter Pilot, Military Specialist, and others. Five core UEEF character classes and 25 MOS skill packages for a wide range of diversity.
- Character creation takes 15 minutes or less with Quick Roll tables.
- A complete Role-Playing Game. 8½ x 11 hardcover, “core rules.” Compatible with other Palladium Books Mega-Damage settings like Rifts®.
- \$30.95 – 224 pages. Cat. No. 550HC.

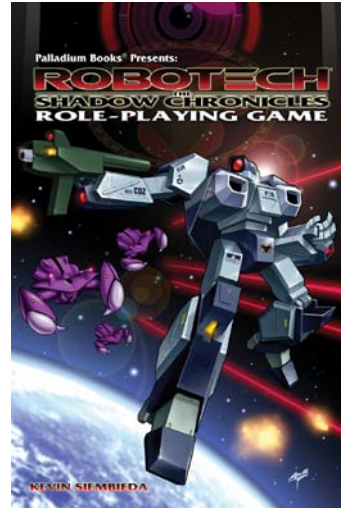

Robotech®: The Shadow Chronicles® RPG – Pocket-Sized Manga Edition

The same Robotech® RPG core rules as above (minus space combat rules and Haydonite spacecraft) in a smaller, “Manga Edition” size; 336 pages, 5 x 7½ inch portable book.

- Fast playing RPG rules. Mega-Damage setting.
- Complete stand-alone RPG.
- Manga size – 5 x 7½ inches – for easy portability.
- \$16.95 – 336 pages. Cat. No. 550.

Robotech®: The Macross® Saga Sourcebook

All your favorite iconic mecha and world setting. The Macross® Saga Sourcebook is a treasure trove of the mecha, Valkyries, Destroids, ground vehicles, aircraft, spacecraft, weapons, Zentraedi aliens, Zentraedi mecha, heroes, villains, action and story that made Robotech® famous.

The story of Macross is one of courage and survival against impossible odds, when an alien invader threatens the survival of all life on Earth. However, Earth’s defenders are far more ready for the Zentraedi alien invaders than they know. Epic adventure. Giant transformable robots. Sacrifice and heroics.

- The famous Valkyrie Veritech Fighters.
- Destroids – giant combat robots that are walking tanks.
- 14 aircraft and aerospace vehicles.
- 13 ground vehicles, plus weapons and equipment.
- 7 Zentraedi mecha, plus Fighter Pod, Recovery Pod, Soldiers, Shuttle and select spacecraft.

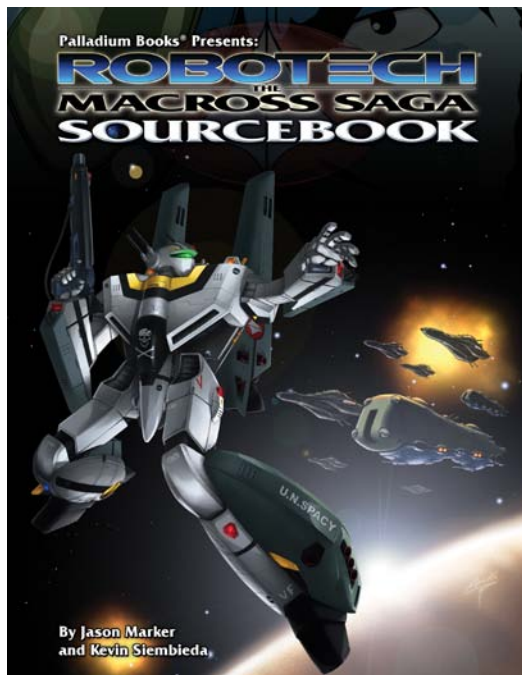

- The Zentraedi: Giant clone warriors and their culture.
- Quick Roll Tables for Macross characters.
- Ordinary People O.C.C., new skills and more.
- Notable anime characters statted out as NPCs.
- \$16.95 – 128 pages. Cat. No. 551. 8½ x 11 inch size.

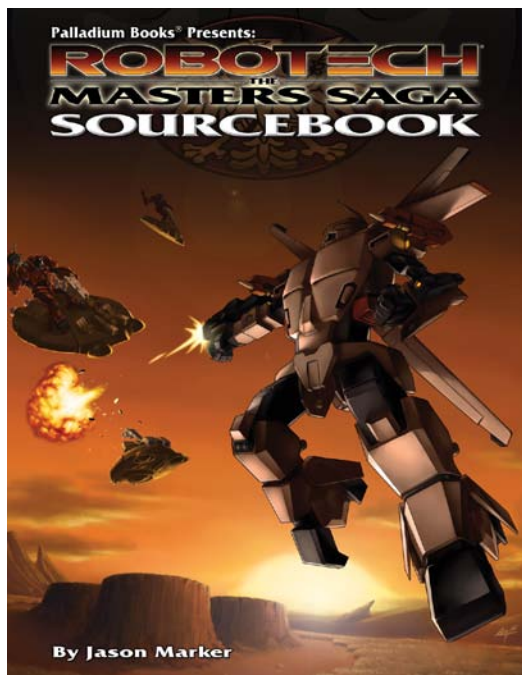

Robotech®: The Masters Saga™ Sourcebook

Never before revealed mecha, power armor, robots, gear and information, all statted out and described. **The Masters Saga™** captures the *Second Robotech War* with never before seen comprehensive details about the mecha, armor, weapons and gear of the 15 divisions of the Army of the Southern Cross (ASC), who battle the new alien threat of the *Robotech Masters*.

The Masters are the visionaries behind Robotechnology and Protoculture. Creators of the giant Zentraedi warriors and the

masters of a crumbling galactic empire won through war and conquest.

Adventures can start in the jungles of South America, where the fledgling ASC and the UEDF battled Zentraedi Malcontents, UEG separatists, rebels and terrorists before the UEEF blasted into outer space; or play during the years of Global Reconstruction. Or start your game the day the Robotech Masters appear and the Second Robotech War begins. Or even play the days between the Masters' defeat and the arrival of the Invid, as well as the years of Invid occupation as your ASC heroes try to rescue survivors and establish resistance groups to battle the Invid until the UEEF fleets return!

- The Army of the Southern Cross™ – all 15 branches.
- Veritech Hover Tanks, AJAX, Logan and more.
- 4 ASC Battlroids plus the Golem robot.
- 6 suits of ASC Powered Armor – never before seen.
- Many vehicles, body armor, jump packs and weapons.
- 7 different Bioroids, Bioroid Hover Sled & weapons.
- Robotech Masters, Tirolians, and their spaceships.
- Tirolian villains and player characters.
- History, background and world information.
- Quick Roll, 15 minute character creation tables.
- Infinite possibilities for adventure.
- \$20.95 – 160 pages. Cat. No. 552. 8½ x 11 inch size.

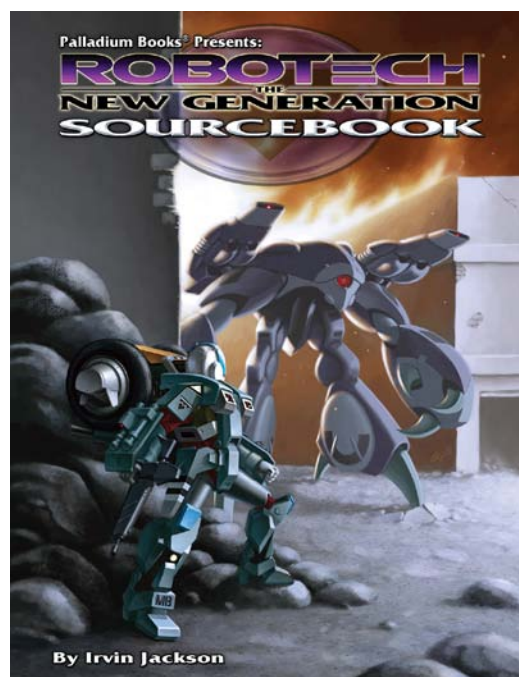

Robotech®: The New Generation™ Sourcebook

The Third Robotech War erupts on Earth. The planet has fallen to the Invid invasion force. You play resistance fighters, a new generation of bold heroes who dare to oppose the frightening alien overlords known as the Invid. Defend the human race against the Invid invaders and rescue the innocent from the alien tyrants.

Best of all, play characters, mecha and weapons from ALL four eras of Robotech® – from Macross and the Masters Saga to New Generation and the Shadow Chronicles®. Or build a Frankenmecha. Epic adventure.

- New and variant mecha, vehicles and weapons.
- Resistance Fighter O.C.C.s & Organization creation rules.
- ALL eras of Robotech mecha are available to players, from the giant Valkyries and Destroids, to Hover Tanks and AJAX, to the small, sleek Alpha Fighters and Cyclones of the UEEF.
- *Frankenmecha* – improvised mecha – amalgamations of different eras of mecha cobbled together into something new and deadly.
- 7 new Occupational Character Classes (O.C.C.s).
- Notable weapons, combat vehicles, and resistance fighters.
- The Regis, Simulagents, Invid Brain, Prince and Princess.
- Global overview under Invid domination and Invid mutations.
- Invid Hives, Protoculture Farms and adventure.
- \$16.95 – 96 pages. Cat. No. 554. 8½ x 11 inch size.



Robotech®: Expeditionary Force Marines™

Expeditionary Force Marines™ is a riveting **Robotech®** sourcebook that carries you to alien worlds. Your characters can pilot the early Cyclones and next generation of Destroids, meet aliens, liberate alien worlds and combat the merciless Invid Regent, his Inorganic shock troopers and Invid swarms. Epic, planet-hopping adventure awaits.

The Robotech®: Expeditionary Force Marines Sourcebook is set in space with the UEEF (United Earth Expeditionary Force) led by Admiral Rick Hunter, Lisa Hayes, Breetai and Exedore. This valiant force of mecha-clad heroes travel across the galaxy liberating planets from the bondage of the Invid Regent, the Robotech Masters and other tyrants and monsters. New alien people are introduced and become part of the Expeditionary Force Marines. In between their ongoing war with the Regent and his Invid and Inorganics, they explore planets, battle space pirates and face treachery on many fronts.

- 5 new Marine O.C.C.s, 22 M.O.S. skill packages, and some new skills.

- 8 new Destroids, two of them Zentraedi, plus a Battloid or two.
- 6 new Cyclones, including Space Cyclones, the Spider Hover Cyclone, the Walker and more.
- CVR-1 and CVR-2 body armor and notable Expeditionary Force (and alien) weapons, gear and vehicles.
- 6 alien races and brief overviews of their planets.
- 34 Perytonian Energy Wizard Magic spells.
- The Regent's war machine: Invid Scientist R.C.C., Invid Assault Trooper (new), Invid Fury (new), Invid Ogre (new), Invid Ranger (new), Garn Inorganic (new), the Regent statted out, and more.
- Quick Roll Creation Tables for UEEF Marines as player characters.
- Time-line for the Expeditionary Force and related events on Earth.
- The *Robotech® The Shadow Chronicles® RPG* "rule book" is needed to play (Cat. No. 550 or 550HC).
- Written by Irvin Jackson and Kevin Siembieda.
- \$20.95 – 160 pages. Cat. No. 553. 8½ x 11 inch size.

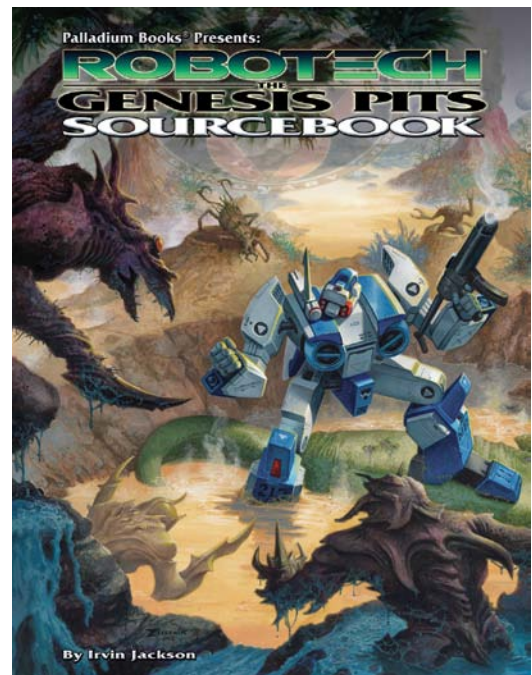

Robotech®: Genesis Pits Sourcebook

An in-depth look at the horror and wonder of the Invid Genesis Pits, their purpose, function and the creatures they create. Rules and tables for creating monsters, stats for different types of dinosaurs, insects and animals, new Frankenmecha, and more.

- **Secrets of the Invid.** Notable Genesis Pits of Earth.
- **Genesis Pit mutations, monsters and mutants.**
- **Different types of Genesis Pits from across the galaxy.**
- **Genesis Pit Monster creation tables and rules.**
- **Mutant Invid and other monsters described and statted.**
- **The Inorganics and other war machines of the Invid Regent.**
- **Ways to destroy a Genesis Pit. New weapons and gear.**
- **Simulagents, Bioroid and Zentraedi mutants, and more.**
- \$16.95 – 96 pages. Cat. No. 555. 8½ x 11 inch size.



ROBOTECH

RPG TACTICS™

Main Boxed Game – Cat. No. 55100 – Available Now!

A fast-paced, strategy battle game that captures the speed and action of Robotech®. Play Earth defenders or Zentraedi invaders.

- Scalable from small squad skirmishes to mass battles.
- Turn-based system of play and uses D6. Two or more players.
- 34 highly detailed game pieces. 6mm scale.
- 112 page color rule book with paint guide and index.
- 53 laminated, color game cards.
- 24 custom dice, two decal sheets and more.
- Assembly and painting required. Glue not included.
- \$99.95 retail – Cat. No. 55100 – shipping now!
- Available in North and South America, the EU, Australia & New Zealand.

Note: Each product contains plastic game pieces requiring assembly and painting. Glue not included. This is not a toy. Small parts, not suitable for children under the age of 13. Adult supervision advised. Images shown here are not to scale.



UEDF Valkyrie Wing™ – Cat. No. 55201

Build your fleet of Earth defenders with the Valkyrie Veritech Fighter; six game pieces total. **\$36.95 retail.**

- 2 Valkyries in Fighter mode.
- 2 Valkyries in Guardian mode.
- 2 Valkyries in Battloid mode.
- Multiple heads for making the VF-1A, VF-1J, VF-1R & VF-1S.



UEDF Tomahawk/Defender Destroids™ – Cat. No. 55202

Expand your Destroid squad with these formidable walking tanks; four game pieces total. **\$32.95 retail.**

- 2 Tomahawk Destroids – the main battle tank of Destroids, brimming with powerful particle beam cannons for arms, and wielding a battery of missiles and an array of other weapons.
- 2 Defender Destroids – a long-range, anti-aircraft juggernaut capable of shooting down incoming Zentraedi Battlepods and Gnerl Fighters.



UEDF Spartan/Phalanx Destroids™ – Cat. No. 55203

Add some long-range power and up-close punch to your army with these valuable Destroids; four game pieces total. **\$32.95 retail.**

- 2 Spartan Destroids – civil defense, riot control and deadly in hand to hand combat.
- 2 Phalanx Destroids – a walking, long-range missile artillery unit.



Zentraedi Regult Battlepods™ – Cat. No. 55401

Expand your Zentraedi forces with their main infantry battle mecha; six game pieces total. **\$36.95 retail.**

- 6 Regult Tactical Battlepods – the lightning quick Regults, armed with a pair of particle cannons and auto-cannons, attack in wave after wave.



Zentraedi Artillery Battlepods™ – Cat. No. 55402

Give your Zentraedi legion greater firepower with these artillery and support Battlepods; four game pieces total. **\$36.95 retail.**

- 4 Zentraedi Support Battlepods, each of which can be made into:
 - Gluuhaug-Regult – Light Artillery Battlepod
 - Serauhaug-Regult – Heavy Artillery Battlepod
 - Telnesta-Regult – Experimental Particle Beam Battlepod
- Four game pieces total.**



Zentraedi Glaug Command™ – Cat. No. 55403

This diverse pack provides your Zentraedi forces with greater tactical capabilities; three game pieces total. **\$36.95 retail.**

- 1 Glaug Officer's Battlepod – the fast and deadly mecha of Zentraedi field leaders.
- 1 Quel-Regult Scout Battlepod – the stealthy eyes and ears of your Zentraedi battle force; electronic warfare capabilities.
- 1 Quel-Gulnau Recovery Pod – enhances the Glaug's ability to bring in Battlepod reinforcements. **Note:** This figure has NEVER before been offered by any company.





RIFTS®

- Imagine Earth transformed into an alien landscape.
- Humans exist – barely. And we are not alone.
- Aliens and monsters emerge from the Rifts – holes torn in the fabric of space and time, connected to countless worlds and realities.
- Ancient gods, demons and magic have returned.
- Magic and technology clash.
- Hundreds of character classes, many inhuman.
- *Rifts® Ultimate Edition* is the core RPG rule book.
- Expansive world setting with 90+ sourcebooks to draw upon.
- Rifts®, your portal to endless adventure.
- Limited only by your imagination.

www.palladiumbooks.com

© 2014 Palladium Books. Rifts®, Megaverse®, Nightbane® and other titles, slogans and likenesses are trademarks of Palladium Books, Inc. Palladium Books - 39074 Webb Court, Westland, MI 48185 USA - 734-271-2903 order line.

Other RPG Worlds from Palladium Books®:

- *Rifts®* – the ultimate role-playing experience.
- *Rifts® Chaos Earth®* – Play the apocalypse as it happens.
- *Splicers®* – Weird science. Bio-tech battles insane robot legions.
- *Robotech® RPG* – All eras of the TV show brought to life.
- *Dead Reign® RPG* – Can you survive the Zombie Apocalypse?
- *Palladium Fantasy RPG®* – Unique world, monsters as player characters, magic and more.
- *Heroes Unlimited™ RPG* – Play any hero; mutants, aliens, cyborgs, superhumans, mages, immortals and more.
- *Nightbane® RPG* – Conspiracy, magic, horror and monsters.
- *Beyond the Supernatural™ RPG* – Modern horror and suspense.
- *Ninjas and Superspies™*, and more.

Can YOU survive the Zombie Apocalypse?



The Dead Reign® RPG series

Dead Reign® RPG – “Core Rules.” It is the aftermath of the *zombie apocalypse*. The dead reign and the living fight against impossible odds. Can you survive? Find out with this fast-paced horror game. Easy to learn. Fast character creation and combat.

- **Zombie combat and survival rules, vehicles and equipment.**
- **6 iconic Character Classes plus Ordinary People (40+ occupations).**
- **7 types of zombies, plus the Half-Living.**
- **101 Random Scenarios, Encounters, Settings and other tables.**
- **\$22.95 retail – 224 pages – Cat. No. 230. Available now.**

Civilization Gone™ Sourcebook

Civilization has crumbled to nothing. There is no army. No government. No help coming. What now?

- **Madmen, Psychopaths, villains, heroes and protectors.**
- **House, home and survivor camp tables, resources & encounters.**
- **\$12.92 retail – 64 pages – Cat. No. 231. Available now.**

Dark Places™ Sourcebook

Travel the rails and urban underground to move about undetected by zombies.

- **Worm Meat, Bug Boy, Sewer Crawler & Impersonator Zombies.**
- **Traveling the rails, sewers and other dark places.**
- **Random encounter tables, boxcar content tables, and much more.**
- **\$12.92 retail – 64 pages – Cat. No. 232. Available now.**

Endless Dead™ Sourcebook

The zombies grow in number and strangeness. Can humankind survive?

- **Zombie amalgamations, tables and encounters.**
- **New player characters & timetables for your campaign.**
- **Weaponizing vehicles, vehicle combat rules, and military bases.**
- **Creating survivor caravans, hideouts, Safe Havens & more.**
- **\$16.95 retail – 96 pages – Cat. No. 233. Available now.**

Other horror titles from Palladium Books®

Beyond the Supernatural™ RPG **Nightbane® RPG**

Fear the Reaper™ Sourcebook

Heroes who, like knights of old, travel the highways fighting zombies and helping survivors.

- **Comprehensive background on the Road Reapers.**
- **Their code, missions, weapons, strategies and tactics.**
- **The Terror Zombie and more.**
- **\$12.95 retail – 48 pages – Cat. No. 234. Available now.**

Graveyard Earth™ Sourcebook

The Zombie Apocalypse across the globe; provides a world overview and many adventure ideas.

- **Many tables for settings, encounters and adventure hooks.**
- **Random Safe Havens by region, and Survivor Leaders.**
- **How to get home from abroad, zombie threat levels & more.**
- **\$12.95 retail – 64 pages – Cat. No. 235. Available now.**

Hell Followed™ Sourcebook

This big, 160 page sourcebook begins to redefine the zombie genre. It broadens the field of possibilities and expands upon the modern zombie mythos. It is full of twists and surprises you will not expect.

- **11 new types of terrifying zombies.**
- **7 player characters, plus Masked Lunatics – heroes or madmen?**
- **21 disasters to complicate survival, and urban survival.**
- **Government enclaves, conspiracy theories and more.**
- **\$20.95 retail – 160 pages – Cat. No. 236. Available now.**



Palladium Books® Check List & Order Form

Dept. P-16, 39074 Webb Court, Westland, MI 48185

Name: _____ Address: _____

City: _____ State: _____ Zip/Postal Code: _____ Country: _____

Credit Card Number: _____ Expiration Date: _____ Visa MasterCard

Telephone Number: _____ Signature: _____ AMEX Other

The Rifter® Series

- ___ 173 The Rifter® #73 – \$13.95
- ___ 174 The Rifter® #74 – \$13.95
- ___ 175 The Rifter® #75 – \$13.95
- ___ 176 The Rifter® #76 – \$13.95
- ___ 177 The Rifter® #77 – \$13.95
- ___ 178 The Rifter® #78 – \$13.95 (Spring)

Splicers® Note: Sourcebooks coming soon.

- ___ 200 Splicers® RPG – \$23.95

Dead Reign®

- ___ 230 Dead Reign® RPG – \$22.95
- ___ 231 SB 1: Civilization Gone™ – \$12.95
- ___ 232 SB 2: Dark Places™ – \$12.95
- ___ 233 SB 3: Endless Dead™ – \$16.95
- ___ 234 SB 4: Fear the Reaper™ – \$12.95
- ___ 235 SB 5: Graveyard Earth™ – \$12.95
- ___ 236 SB 6: Hell Followed™ – \$20.95

Rifts® Novels

- ___ 301 Sonic Boom™ – \$9.95
- ___ 302 Deception's Web™ – \$9.95
- ___ 303 Treacherous Awakenings™ – \$9.95
- ___ 304 Tales of the Chi-Town 'Burbs™ – \$12.95
- ___ 305 Rifts® Path of the Storm™ – \$12.95

Weapons Books

- ___ 401 Weapons and Armor™ – \$8.95
- ___ 402 Weapons and Castles™ – \$8.95
- ___ 403 Weapons and Assassins™ – \$9.95
- ___ 404 Weapons & Castles of the Orient™ – \$9.95
- ___ 409 Exotic Weapons™ – \$9.95
- ___ 410 European Castles™ – \$9.95

Palladium Fantasy RPG®

- ___ 450 The Palladium Fantasy RPG® – \$26.95
- ___ 4500HC Palladium Fantasy RPG® 30th Anniversary Hardcover – \$50.00
- ___ 451 Dragons & Gods™ – \$24.95
- ___ 453 Old Ones™ 2nd Ed. – \$24.95
- ___ 454 Monsters & Animals™ 2nd Ed. – \$24.95
- ___ 455 Adventures on the High Seas™ – \$24.95
- ___ 458 Island at the Edge of the World™ – \$20.95
- ___ 459 Yin-Sloth Jungles™ – \$20.95
- ___ 462 Western Empire™ – \$24.95
- ___ 463 Baalgor Wastelands™ – \$24.95
- ___ 464 Mount Nimro™ – \$20.95
- ___ 465 Eastern Territory™ – \$24.95
- ___ 466 Library of Bletcherad™ – \$20.95
- ___ 467 Northern Hinterlands™ – \$24.95
- ___ 468 Land/Damned 1: Chaos Lands™ – \$24.95
- ___ 469 LoD 2: Eternal Torment™ – \$24.95
- ___ 470 LoD 3: The Citadel – \$24.95 (coming)
- ___ 471 Wolfen Empire™ – \$20.95
- ___ 472 Mysteries of Magic™ One: Heart of Magic – \$16.95
- ___ 474 Bizantium/Northern Islands™ – \$20.95
- ___ 475 Garden of the Gods™ – \$16.95 (coming)

Heroes Unlimited™ / After the Bomb®

- ___ 500-2 Heroes Unlimited™, 2nd Ed. – \$26.95
- ___ 5000HC Heroes Unlimited™ 30th Anniversary Hardcover – \$50.00
- ___ 501 Villains Unlimited™ Revised – \$24.95
- ___ 503 After the Bomb® RPG – \$24.95
- ___ 505 Road Hogs™ (After the Bomb® II) – \$9.95
- ___ 507 Mutants Down Under™ (AB III) – \$9.95
- ___ 511 Mutants of the Yucatan™ (AB IV) – \$9.95
- ___ 513 Mutants in Avalon™ (AB V) – \$16.95
- ___ 514 Mutants in Orbit™ (AB VI) – \$16.95
- ___ 515 Aliens Unlimited™ – \$24.95
- ___ 516 Heroes Unlimited™ G.M.'s Guide – \$24.95
- ___ 517 Century Station™ – \$24.95
- ___ 518 Gramercy Island™ – \$24.95
- ___ 519 Aliens Unlimited Galaxy Guide™ – \$24.95
- ___ 520 Mutant Underground™ – \$16.95
- ___ 521 Powers Unlimited® One – \$16.95
- ___ 522 Powers Unlimited® Two – \$16.95
- ___ 523 Powers Unlimited® Three – \$16.95
- ___ 525 Revised Ninjas & Superspies™ – \$20.95
- ___ 526 Mystic China™ – \$24.95
- ___ 527 Armageddon Unlimited™ – \$20.95

Robotech® RPG

- ___ 550 Robotech® The Shadow Chronicles® RPG (manga size) – \$16.95
- ___ 550HC Robotech® The Shadow Chronicles® Deluxe Hardcover RPG – \$30.95
- ___ 5500HC Robotech® The Shadow Chronicles® Gold Ed. Hardcover RPG – \$70.00
- ___ 551 Robotech® Macross® Saga Sourcebook – \$16.95
- ___ 552 Robotech® The Masters Saga™ Sourcebook (NEW in 8½ x 11) – \$20.95
- ___ 553 Robotech®: Expeditionary Force Marines Sourcebook – \$20.95
- ___ 554 Robotech® The New Generation™ Sourcebook – \$16.95
- ___ 555 Robotech® Genesis Pits Sourcebook – \$16.95

Robotech® RPG Tactics™ (New!)

- ___ 55100 Robotech® RPG Tactics™ – \$99.95
- ___ 55105 Robotech® RPG Tactics™ Rulebook – \$20.00
- ___ 55101 UEDF Dice Pack – \$12.00
- ___ 55102 Zentraedi Dice Pack – \$12.00
- ___ 55201 UEDF Valkyrie Wing – \$36.95
- ___ 55202 UEDF Destroid Pack – \$32.95
- ___ 55203 UEDF Spartan Pack – \$32.95
- ___ 55401 Zentraedi Regult Battlepods – \$36.95
- ___ 55402 Zentraedi Artillery Battlepods – \$36.95
- ___ 55403 Zentraedi Glaug Command – \$36.95

Rifts® Chaos Earth®

- ___ 660 Rifts® Chaos Earth® RPG – \$20.95
- ___ 661 Rifts® CE Creatures of Chaos™ – \$12.95
- ___ 662 Rifts® CE The Rise of Magic™ – \$12.95
- ___ 665 Rifts® Chaos Earth® First Responders™ – \$16.95 (coming)
- ___ 666 Rifts® Chaos Earth® Resurrection™ – \$20.95

Beyond the Supernatural™

- ___ 700 Beyond the Supernatural™, 2nd Ed. – \$24.95
- ___ 702 Tome Grotesque™ – \$20.95 (coming)
- ___ 703 Beyond Arcanum™ – \$24.95 (coming)

Nightbane®

- ___ 730 Nightbane® RPG – \$24.95
- ___ 731 Nightbane®: Between the Shadows™ – \$20.95
- ___ 732 Nightbane®: Nighlands™ – \$20.95
- ___ 733 Nightbane®: Through the Glass Darkly™ – \$20.95
- ___ 735 Nightbane® Survival Guide™ – \$20.95

Rifts®

- ___ 800HC Rifts® RPG Ultimate Edition – \$39.95
- ___ 801 Rifts® Sourcebook One Revised – \$20.95
- ___ 802-E Rifts® World Book 1: Vampire Kingdoms™, Revised – \$24.95
- ___ 803 Rifts® Conversion Book One™ – \$24.95
- ___ 804 Rifts® WB 2: Atlantis™ – \$20.95
- ___ 805 Rifts® Sourcebook 2: Mechanoids™ – \$16.95
- ___ 807 Rifts® WB 3: England™ – \$20.95
- ___ 808 Rifts® WB 4: Africa™ – \$20.95
- ___ 809 Rifts® Dimension Book 1: Wormwood™ – \$20.95
- ___ 810 Rifts® WB 5: Triax™ – \$24.95
- ___ 811 Rifts® Pantheons of the Megaverse® – \$24.95
- ___ 812 Rifts® Sourcebook 3: Mindwerks™ – \$16.95
- ___ 813 Rifts® Mercenaries™ – \$20.95
- ___ 814 Rifts® WB 6: South America™ – \$20.95
- ___ 815 Rifts® WB 7: Underseas™ – \$24.95
- ___ 816 Rifts® DB 2: Phase World® – \$24.95
- ___ 817 Rifts® DB 3: Phase World® Sourcebook – \$16.95
- ___ 818 Rifts® WB 8: Rifts® Japan™ – \$24.95
- ___ 819 Rifts® WB 9: South America Two™ – \$24.95
- ___ 820 Rifts® WB 10: Juicer Uprising™ – \$20.95
- ___ 821 Rifts® WB 11: Coalition War Campaign™ – \$24.95

- ___ 822 Rifts® WB 12: Psyscape™ – \$20.95
 ___ 825 Rifts® WB 13: Lone Star™ – \$20.95
 ___ 826 Rifts® WB 14: New West™ – \$24.95
 ___ 827 Rifts® WB 15: Spirit West™ – \$24.95
 ___ 828 Rifts® Sourcebook 4: Coalition Navy™ – \$16.95
 ___ 829 Rifts® WB 16: Federation of Magic™ – \$20.95
 ___ 830 Rifts® DB 4: Skraypers™ – \$20.95
 ___ 831 Rifts® Index Volume Two™ – \$16.95
 ___ 832 Rifts® WB 17: Warlords of Russia™ – \$24.95
 ___ 833 Rifts® WB 18: Mystic Russia™ – \$20.95
 ___ 834 Rifts® WB 19: Australia 1 – \$24.95
 ___ 835 Rifts® WB 20: Canada™ – \$24.95
 ___ 836 Rifts® WB 21: Splynn Dimensional Market™ – \$24.95
 ___ 837 Rifts® WB 22: Free Quebec™ – \$24.95
 ___ 838 Rifts® WB 23: Xiticix Invasion™ – \$20.95
 ___ 839 Rifts® Coalition Wars®: Sedition™ – \$20.95
 ___ 840 Rifts® Coalition Wars®: Coalition Overkill™ – \$16.95
 ___ 841 Rifts® Coalition Wars®: Sorcerers' Revenge™ – \$16.95
 ___ 842 Rifts® Coalition Wars®: Cyber-Knights™ – \$16.95
 ___ 843 Rifts® Coalition Wars®: Shadows of Evil™ – \$16.95
 ___ 844 Rifts® Coalition Wars®: Final Siege™ – \$24.95
 ___ 845 Rifts® Game Master Guide™ – \$26.95
 ___ 846 Rifts® Aftermath™ – \$24.95
 ___ 847 Rifts® DB5: Anvil Galaxy™ – \$20.95
 ___ 848 Rifts® Book of Magic™ – \$26.95
 ___ 849 Rifts® Adventure Guide™ – \$24.95
 ___ 850 Rifts® Bionics Sourcebook™ – \$16.95
 ___ 851 Rifts® DB 6: Three Galaxies™ – \$20.95
 ___ 852 Rifts® Dark Conversions™ – \$24.95
 ___ 853 Rifts® Chi-Town 'Burbs™ – \$9.95
 ___ 854 Rifts® The Tolkien Crisis™ – \$12.95
 ___ 855 Rifts® The Black Vault™ – \$9.95
 ___ 856 Rifts® The Vanguard™ – \$9.95
 ___ 857 Rifts® WB 24: China One™ – \$20.95
 ___ 858 Rifts® WB 25: China Two™ – \$20.95
 ___ 859 Rifts® DB 7: Megaverse Builder™ – \$16.95
 ___ 860 Rifts® DB 8: Naruni Wave Two™ – \$16.95
 ___ 862 Rifts® WB 26: Dinosaur Swamp™ – \$20.95
 ___ 863 Rifts® MercTown™ – \$20.95
 ___ 865 Rifts® Merc Ops™ – \$20.95
 ___ 866 Rifts® WB 27: Adventures in Dinosaur Swamp™ – \$20.95
 ___ 867 Rifts® Mercenary Adventure Sourcebook – \$12.95
 ___ 868 Rifts® WB 28: Arzno™ – \$20.95
 ___ 869 Rifts® WB 29: Madhaven™ – \$16.95
 ___ 870 Rifts® John Zeleznik Coloring Book – \$5.95
 ___ 871 Rifts® Machinations of Doom™ – \$18.95
 ___ 872 Rifts® DB 10: Hades™ – \$24.95
 ___ 873 Rifts® DB 11: Dyval™ – \$24.95
 ___ 874 Rifts® WB 30: D-Bees of North America™ – \$24.95
 ___ 875 Rifts® DB12: Dimensional Outbreak – \$24.95
 ___ 876 Rifts® Megaverse® in Flames™ – \$24.95
 ___ 876HC Rifts® Megaverse® in Flames™ Gold Hardcover Edition – \$50.00
 ___ 877 Rifts® Heroes of the Megaverse® – \$16.95
 ___ 878 Rifts® Sourcebook: Shemarrian Nation™ – \$16.95
 ___ 880 Phase World®: Fleets of the Three Galaxies™ – \$16.95
 ___ 881 Rifts® WB 31: Triax™ Two – \$24.95
 ___ 883 Rifts® DB 14: Thundercloud Galaxy™ – \$20.95
 ___ 884 Rifts® Vampires Sourcebook™ – \$20.95
 ___ 885 Rifts® WB 32: Lemuria™ – \$24.95
 ___ 886 Rifts® Black Market™ – \$24.95
 ___ 886HC Rifts® Black Market™ Hardcover Gold Edition – \$60.00
 ___ 887 Rifts® WB 33: Northern Gun™ One – \$24.95
 ___ 888 Rifts® WB 34: Northern Gun™ Two – \$26.95
 ___ 889 Rifts® Sourcebook: Coalition States, Heroes of Humanity™ – \$20.95
 ___ 890 Rifts® World Book: Secrets of the Atlanteans™ – \$24.95 (coming)
 ___ 891 Rifts® World Book: Sovietski™ – \$24.95 (coming)
 ___ 892 Rifts® Sourcebook: The Disavowed™ – \$16.95 (coming)
 ___ 893 Rifts® CS: Heroes of Humanity™ Arsenal Sourcebook – \$16.95 (coming)
 ___ 894 Rifts® Haunted Tech™ – \$16.95 (coming)
 ___ 2510 Rifts® & The Megaverse® Art Book – \$22.95
 ___ 2510-HC Rifts® & The Megaverse® Art Book, Hardcover – \$50.00
 ___ 2510-CML Rifts® & The Megaverse® Art Book, Collector's Masterwork Edition – \$125.00
- Miscellaneous Products**
 ___ 600 Deluxe Revised RECON® RPG – \$22.95
 ___ 2537 Gamer Coffee Mug – \$10.00
 ___ 2539 Rifts® Dice Bag – Black – \$8.00
 ___ 2545 Dead Reign™ Coffee Mug – \$10.00
 ___ 2554 Palladium Bookmarks, Set One – \$5.00
 ___ 2555 Palladium Bookmarks, Set Two – \$5.00
 ___ 2561 Property of Chi-Town Library Pencil – \$0.50 each
 ___ 2562 Future Visions™ – The Artistry of Charles Walton II – \$13.95
 ___ 2566 Glitter Boy Mouse Pad – \$9.95
 ___ 2567 Old Ones Mouse Pad – \$9.95
 ___ 2568 Zombie Graveyard Mouse Pad – \$9.95
- Note:** T-shirts and other products can be found online: www.palladiumbooks.com
- Rifts® Miniatures**
 ___ MI8002 Xiticix Pack – \$18.00
 ___ MI8004 Coalition Dog Pack – \$18.00
 ___ MI8005 Men of Magic Pack #1 – \$18.00
 ___ MI8006 Cyborgs Pack #1 – \$18.00
 ___ MI8007 Simvan & Ostrosaurus Pack – \$18.00
 ___ MI8008 Coalition Skelebots Pack #1 – \$18.00
 ___ MI8009 Coalition SAMAS Pack #1 – \$22.00
 ___ MI8010 Coalition Sky Cycle Pack – \$22.00
 ___ MI8011 Coalition Dog Pack #2 – \$18.00
 ___ MI8015 Damaged Skelebots Pack #1 – \$12.00
 ___ MI8016 Cyber-Adventurers Pack – \$18.00
 ___ MI8017 Rogues & Scout Pack #1 – \$18.00
 ___ MI8018 Brodkil & Witchling Pack – \$18.00
 ___ MI8019 Damaged Skelebots Pack #2 – \$18.00
 ___ MI8020 Psi-Stalkers & Scouts Pack #1 – \$18.00
 ___ MI8021 Shadow Beast – \$12.00
 ___ MI8022 Mystic Knight – \$6.00
 ___ MI8023 Lord Magus – \$6.00
 ___ MI8024 High Magus – \$6.00
 ___ MI8025 Coalition Psi-Stalker – \$6.00
 ___ MI8026 Coalition Dog Boy in DPM-D1 Armor – \$6.00
 ___ MI8027 Coalition Dog Boy #2 – \$6.00
 ___ MI8028 Coalition Dog Boy #3 – \$6.00
 ___ MI8029 Coalition Dog Boy #4 – \$6.00
 ___ MI8030 Coalition Dog Boy #5 – \$6.00
 ___ MI8031 Glitter Boy – \$20.00
 ___ MI8032 Glitter Boy Pilot – \$6.00
 ___ MI8033 Kydian Overlord – \$20.00
 ___ MI8034 Dragonsaurus – \$10.00
 ___ MI8035 Slaver and Slave (Atlantis) Set – \$10.00
 ___ MI8036 Crazy – \$6.00
 ___ MI8037 Juicer #1 – \$6.00
 ___ MI8038 Juicer #2 – \$6.00
 ___ MI8039 Cyborg #1 – \$12.00
 ___ MI8040 Cyborg #2 – \$12.00
 ___ MI8041 Cyborg #3 – \$6.00
 ___ MI8042 Coalition Officer – \$6.00
 ___ MI8043 Coalition Grunt #1 – \$6.00
 ___ MI8044 Coalition Grunt #2 – \$6.00
 ___ MI8045 Coalition Grunt #3 – \$6.00
- When placing an order by mail, please add money for shipping and handling.** Add \$5.00 for orders totaling \$1-\$50, \$10.00 for orders totaling \$51-\$95, and for orders totaling \$96-\$200 please add \$15.00 US. Double the amount for Canada, and *quadruple* it for overseas orders. For more shipping options, order online at www.palladiumbooks.com. Allow 2-4 weeks for delivery. Make checks and money orders payable to: *Palladium Books*
- Check release dates for new products.** If the book you order has not been released yet, your order will be held as a backorder until the product is available. Please note that prices are subject to change without notice.
- Orders can also be placed by phone,** at (734) 721-2903 (order line only). Please have your credit card information when you call.
- www.palladiumbooks.com**



Insignia of G.M.P.

\$20.95

Cat. No. RO8053

ISBN-10: 0-916211-27-4

ISBN-13: 978-0-916211-27-1